

SPEEDCHECK®

Radar Speed Signs / "YOUR SPEED" Signs



Radar speed signs have an immediate and long-lasting impact on driver behavior, alerting drivers to the recommended speed for an area, condition or hazard.

- ✓ Industry-leading high-contrast display technology for visibility in all weather and lighting conditions
- ✓ MUTCD and Buy America compliant system
- ✓ Most recognized radar speed sign in the industry for 20+ years
- ✓ Energy Balance Report™ (EBR) prepared for every location to ensure battery longevity

Ultra-clear Light Output

Both 15-inch and 18-inch-digit systems have a 7-segment design with high-contrast display technology for visibility in all weather and lighting conditions. LEDs dim during nighttime operation, no "88" ghosting is visible day or night, and characters have smooth, recognizable digits and letters. SpeedCheck's proprietary safety mask limits the viewing angle to prevent drivers from watching the display as they pass.

The flashing digits and optional "Slow Down" message can be programmed to flash at user-defined speed thresholds—the faster the speed, the faster the flash. High-speed cutoff prevents drivers from racing the sign. Signs are MUTCD compliant, install quickly, and can be powered by a solar or AC system.

Easy Installation and Durable Construction

The modular design makes it easy to repair using standard tools—without removing the device from the pole. The durable radar device is constructed with heavy 11-gauge welded aluminum and stainless steel and brass hardware. The vandal-resistant design can absorb up to two inches of impact deflection without damage to internal components.

Advanced User Interface

Our SpeedCheck sign comes with an on-board user interface for quick configuration and optional status monitoring. Using a shared platform design, all SpeedCheck products use the same device manager and controller, making it easy to quickly add many optional features to fit your application.

Reliable

Designed with Carmanah's industry-leading solar modeling tools to provide dependable year-after-year operation. We prepare an Energy Balance Report (EBR) for every location.

Trusted for 20+ Years

With thousands of installations, Carmanah's systems are the benchmark in traffic applications and other transportation applications worldwide.



SPEEDCHECK-15

15-inch digits for speeds less than 45 mph (70 km/h)

SPEEDCHECK-18

18-inch digits for speeds 45 mph (70 km/h) and over

SPEEDCHECK®

Radar Speed Signs / "YOUR SPEED" Signs

1.844.412.8395 | traffic@carmanah.com | carmanah.com



DISPLAY ENCLOSURE DIMENSIONS

SPEEDCHECK-15

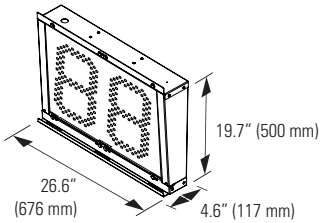

SPEEDCHECK-18

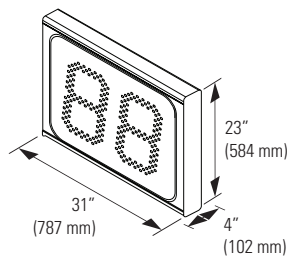

DISPLAY ENCLOSURE MOUNTING

Standard Banding

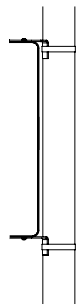

U-Bolt (Flat/Square poles)

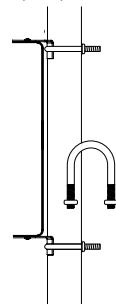

Tilt Bracket (for vertical adjustments)

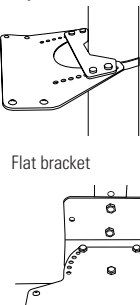

Quick Change (Portable)

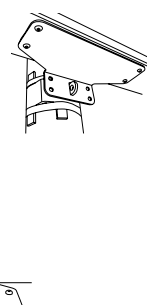

Flat bracket

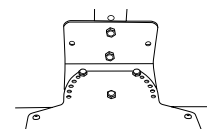

SOLAR PANEL MOUNTING

4.5" Diameter Round Top of Pole Mount

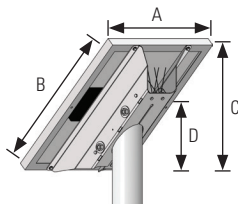

Side of Pole Mount

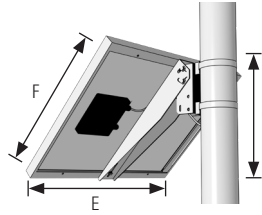

PANELS*	A	B	C	D	E	F	G
50 W	21.2" (538 mm)	26.3" (668 mm)	19.6" (497 mm)	10.0" (254 mm)	26.3" (668 mm)	21.2" (538 mm)	16.0" (405 mm)
80 W	30.7" (780 mm)	26.5" (672 mm)	19.7" (500 mm)	10.0" (254 mm)	30.7" (780 mm)	26.5" (672 mm)	19.7" (500 mm)
170 W	59.1" (1500 mm)	26.3" (668 mm)	19.7" (501 mm)	10.0" (254 mm)	59.1" (1500 mm)	26.3" (668 mm)	35.7" (907 mm)

* Carmanah will conduct a site assessment and provide an Energy Balance Report™ to determine the correct solar panel and battery size.

CABINET DIMENSIONS

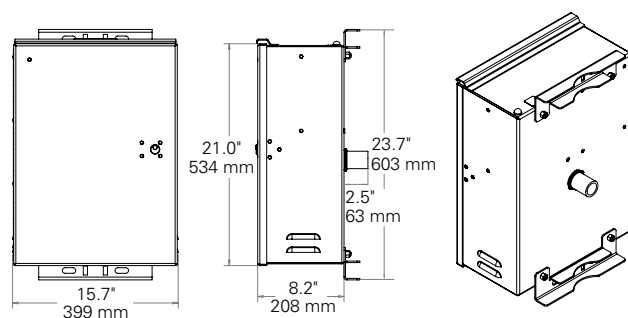

SYSTEM SPECIFICATIONS

Display	MUTCD and MUTCDC compliant Amber LEDs Seven-segment LED digit design for maximum digit recognition LEDs automatically dim during nighttime operation, minimizing light bounce into neighboring windows Unique safety masking design limits display view from the side, discouraging drivers from rubbernecking to watch the display as they drive past Ultra-clear contrast delivers superior viewability in all lighting conditions No "88" digit ghosting even in bright sunlight
Power	100-240 VAC in standard configurations 12 VDC for battery or solar system operation Solar sized for specific geographic location and sign application 3.5 W draw for typical daytime displayed number, traffic, and local illumination 50, 80, or 170 W high-efficiency photovoltaic solar panel
Enclosure	Ventilated, weatherproof NEMA 3R enclosure
Static Sign Construction	3M High Intensity Prismatic or Diamond Grade retroreflective sheeting and components Available in 3931 yellow, 3983 fluorescent yellow/green, 3930 white, and 3934 orange; others available
Communication	Bluetooth, StreetHub remote connectivity, ethernet, and third-party device communication options available
Software	SpeedCheck Manager: simple setup and programming for all display parameters Scheduler: manages unlimited schedules and modes on a calendar with a 2-year exception list Traffic Analyzer: on-board data logger collects date, time and speed for over 200,000 target vehicles; raw data in .csv, not binned; generates easy pre-defined speed compliance reports
Cabinet Construction	Weatherproof, gasketed enclosure with vents for ambient air transfer (NEMA 3R) Lockable, hinged door with #2 lock Optional padlockable latch Corrosion-resistant aluminum with stainless steel hardware
Environmental	-40 to 167° F (-40 to 75° C) system operating temperature 5-30 Hz 3-axis vibration FCC 15.107 and 15.109 Class A radiated and conducted emissions compliance FCC part 15 low-power radar device
Warranty	3-year limited warranty

OPTIONAL PRODUCT FEATURES

Slow Down	Flashes MUTCD-compliant "Slow Down" message when drivers exceed user-defined speed thresholds
Outputs	Triggers external devices, such as flashing beacons, strobes, or cameras by speed threshold or schedule, or from centralized remote location Beacons: 12 in (305 mm) or 8 in (203 mm) diameter LED modules, yellow or red
Inputs	Allows external devices to manage display operation with external contact closure and the included wiring harness

"YOUR SPEED" SIGN DIMENSIONS

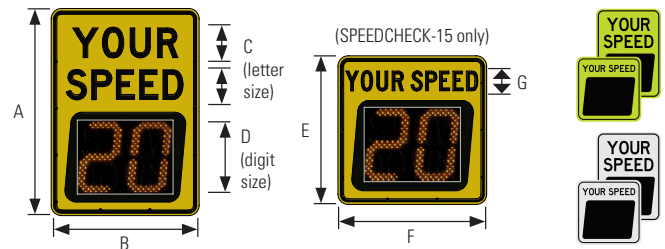

SIGN	A	B	C	D	E	F	G
15-inch	42" (1067 mm)	30" (762 mm)	6" (152 mm)	15" (381 mm)	30" (762 mm)	30" (762 mm)	4" (102 mm)
18-inch	48" (1219 mm)	36" (914 mm)	6.5" (165 mm)	18" (457 mm)	-	-	-



Specifications subject to local environmental conditions, and may be subject to change.

All Carmanah products are manufactured in facilities that are certified to ISO quality standards.

"Carmanah" and Carmanah logo are trademarks of Carmanah Technologies Corp.

© 2020, Carmanah Technologies Corp.

Document: SPEC_TRA_SpeedCheck-radar-speed-signs_RevC