

**104th and Tower Retail/Restaurant Development
Commerce City, CO
Traffic Impact Study**

Prepared For:

18494 104th LLC
2946 East 51st Drive
Denver, CO 80238
(720) 989-4745

City of Commerce City
7887 E. 60th Avenue
Commerce City, CO 80022

Prepared By:



JR Engineering, LLC
7200 S. Alton Way, C400
Centennial, CO 80112

Contact: Eli Farney, PE

October 4, 2023

Table of Contents

Section 1: Introduction.....	1
Purpose of Report and Study Objectives	1
Site Description.....	1
Background Developments and Roadway Improvements	1
Proposed Parcel Descriptions	1
Study Area Boundaries	1
Existing and Proposed Site Uses.....	2
Existing and Proposed Land Uses.....	2
Existing Roadway Network	4
Proposed Site Access and Roadways.....	4
Section 2: Existing and Projected Traffic Volumes.....	4
Data Collection	4
Background Traffic Projections	7
Project Traffic	10
Trip Generation.....	10
Project Trip Distribution.....	11
Total Traffic	11
Section 3: Traffic Operations and Project Impacts	16
Level of Service Information	16
Level of Service Results	17
Analysis of Existing Condition.....	18
Analysis of Year 2025 Opening Day	19
Analysis of Future Year 2045 Future.....	21
Year 2045 Turn Lane Lengths	23
Section 4: Conclusion	25
Trip Generation, Distribution and Assignment.....	25
Traffic Operations and Project Impacts	25
Year 2023 Existing Condition	25
Year 2025 Opening Day	25
Year 2045 Future	26
Recommendations.....	26

List of Figures

Figure 1 – Vicinity Map..... 3
 Figure 2 – Year 2023 Existing Volumes and Lane Geometry..... 6
 Figure 3 – Year 2025 Background Traffic and Lane Geometry..... 8
 Figure 4 – Year 2045 Background Traffic and Lane Geometry..... 9
 Figure 5 – Directional Distribution of Site Generated Traffic..... 12
 Figure 6 – Site Generated Traffic 13
 Figure 7 – Year 2025 Opening Day Traffic..... 14
 Figure 8 – Year 2045 Future Traffic..... 15

List of Tables

Table 1 – Trip Generation Table..... 10
 Table 2 – Signalized Intersection (Auto Mode) LOS Thresholds 16
 Table 3 – TWSC Intersection (Auto Mode) LOS Thresholds 17
 Table 4 – LOS for Year 2023 Existing Condition 18
 Table 5 – LOS for Year 2025 Traffic 20
 Table 6 – LOS for Year 2045 Future Traffic 22

Appendices

- Appendix A: Traffic Counts
- Appendix B: Traffic Signal Timing
- Appendix C: Trip Generation Reports
- Appendix D: *HCM 6th Edition* Level of Service Reports
- Appendix E: 104th Retail and Restaurant Site Plan
- Appendix F: Excerpts of the *Reunion Center* Master TIS, *103rd & Tower Road – Reunion Commercial Center* TIS, and *Reunion Center – Duet & Commercial Phase* Traffic Conformance Letter

Section 1: Introduction

Purpose of Report and Study Objectives

This Traffic Impact Study (TIS) has been prepared by JR Engineering (JR) for the 104th and Tower Retail and Restaurant Development southwest of the intersection of 104th Avenue and Tower Road. The purpose of this TIS is to assess the short-term and long-term effects of the proposed development on both the local and regional transportation system.

The Year 2022 Existing Traffic, Year 2025 Opening Day Traffic, and Year 2045 Future Traffic are evaluated in this study.

Site Description

The 104th and Tower Retail and Restaurant Development is located within Section 16, Township 2 South, Range 66 West of the 6th Principal Meridian, City of Commerce City, County of Adams, State of Colorado. The project site for the Restaurant and Retail Development is bounded to the west and south by private local roads, to the north by E. 104th Avenue, and to the east by Tower Road.

Background Developments and Roadway Improvements

Outside of existing traffic signals at the intersections of 104th Avenue & Walden Street as well as 104th Avenue & Tower Road, the only roadway improvements are site accesses along the private local roads. Necessary

Proposed Parcel Descriptions

The project site encompasses approximately 1.5 acres. The most recent site plan is dated August 2023 by Frontline Engineering. The site is proposed to be comprised of the following land uses:

- Lot 1 – Restaurant with a Patio (combined 7,617 ft²)
- Lot 2 – Three retail sites (combined 6,130 ft²)

The site plan is attached as **Appendix E**.

Study Area Boundaries

Based on the site generated traffic, the following intersections will be analyzed:

- 104th Avenue & Walden Street (E1)
- 104th Avenue & Yampa Street (E2)
- 104th Avenue & Tower Road (E3)
- Tower Road & Right-in/Right-out Access (E4)
- Tower Road & 103rd Avenue (E5)

The vicinity map is shown in **Figure 1**.

Existing and Proposed Site Uses

The existing lot of land is vacant and comprised of relatively flat grasslands, typical of eastern Colorado prairie farmland. Half of the lot has grassland vegetation whereas the other half is exposed dirt. The existing vegetation will need to be removed with the construction of the development. The proposed parcel is planned to be mixed use with a restaurant and commercial/retail.

Existing and Proposed Land Uses

The zoning for the development is PUD (Planned Unit Development) and owned by 18494 10th LLC Based on Commerce City criteria, a development plan permit is required prior to a building permit. The development has already been planned and no re-zoning will be required.

Figure 1 - Vicinity Map



LEGEND

 PROJECT SITE

700 340 0 1400

ORIGINAL SCALE: 1" = 700'

7200 South Alton Way, Suite C400, Centennial, CO 80112
303-740-9393 • Fax: 303-721-9019 • www.jrengineering.com

 **J-R ENGINEERING**

Existing Roadway Network

Currently, all intersections are located within the city limits of Commerce City. The main existing roadways to access the lots are East 104th Avenue, Tower Road, and Walden Street. The existing roadway and transportation network is described as follows:

The existing lane geometry on East 104th Avenue consists of the following:

- 104th Avenue is a principal arterial running east and west with a posted speed limit of 45 MPH in the vicinity of the site. Currently, 104th Avenue consists of six travel lanes east of Walden Street to Tower Road, and tapers down to two travel lanes near the E-470 interchange.

The existing intersections on East 104th Avenue consist of the following:

- Signalized intersections at Walden Street and Tower Road.
- Stop-controlled 3/4 movement intersection at Yampa Street approximately 600 feet east of Walden Street.

The existing lane geometry on Tower Road consists of the following:

- Tower Road is a principal arterial running north and south with a posted speed limit of 45 MPH in the vicinity of the site. Currently, Tower road consists of three travel lanes: two north of 104th Avenue and one south of 104th Avenue.

The existing intersections on Tower Road consist of the following:

- Signalized intersection at 104th Avenue at the north eastern boundary of the site.
- Stop-controlled Right-In/Right-Out (RIRO) private access approximately 370 feet south of 104th Avenue.
- Two-Way Stop-Controlled (TWSC) intersection at 103rd Avenue approximately 630 feet south of 104th Avenue.

Proposed Site Access and Roadways

Other than the existing roadway network, the only proposed improvement for this site is a site access. Of which will be located west of the Right-In/Right-Out private access along Tower Road.

Section 2: Existing and Projected Traffic Volumes

Data Collection

Existing turning movement counts were collected by All Traffic Data on August 23, 2022 at the intersections of Walden Street & 104th Avenue (E1) and 104th Avenue & Tower Road (E3) as a part of the *103rd and Tower Development Traffic Impact Study* by JR Engineering, dated August 22, 2023.

The counts were collected from 7:00-9:00 AM and 4:00-6:00 PM, with the AM and PM peak hours generally occurring from 7:15 AM to 8:15 AM and 4:30 PM to 5:30 PM, respectively.

Existing turning movement counts for the intersection of 104th Avenue & Yampa Street (E2) were calculated using the collected data from E1 and E3. The methodology used to determine turning volumes was as such: movements turning on to 104th Avenue using intersection E1 were counted and compared to the volume of eastbound traffic at E3. Any difference in these two volumes was assumed to have turned right into or out of E2. This was then repeated in the westbound direction to determine the volumes turning left into E2.

Existing turning movement counts for the intersection of Tower Road & Private Access (E4) were calculated using the same methodology used in determining E2's volumes. However, the intersections E3 and E5 were used for this intersection instead with the same idea of using the differences in both northbound and southbound traffic volumes to estimate turning volumes on to E4.

Existing turning movement counts were collected by All Traffic Data on July 25, 2023 at the intersection of Tower Road and 103rd Avenue (E5) as a part of the *103rd and Tower Development Traffic Impact Study* by JR Engineering, dated August 22, 2023.

The counts were collected from 7:00-9:00 AM and 4:00-6:00 PM, with the AM and PM peak hours occurring from 7:15 AM to 8:15 AM and 5:00 PM to 6:00 PM, respectively.

The AM and PM peak hour volumes were used in the analysis of the existing condition.

All Traffic Data also collected 24-hour tube counts along Tower Road south of 104th Avenue on July 25, 2023. The counts were used to estimate the average daily traffic (ADT).

Existing lane geometry and traffic volumes are shown in **Figure 2**. The actual traffic counts collected by All Traffic Data are included in **Appendix A**.

Additionally, signal timing plans along the 104th Avenue corridor (from State Highway 2 to Tower Road) were prepared by Michael Baker International on February 2, 2022 and provided by the City. The Implemented Signal Timing cycle length and parameters per their Synchro reports were utilized in Years 2023 and 2025. The cycle lengths and phasing splits were optimized as necessary with projected future traffic in Year 2045. These timing reports are included in **Appendix B**.



Figure 2 - Year 2023 Existing Traffic and Lane Geometry

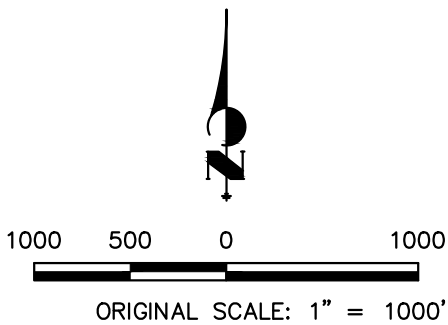
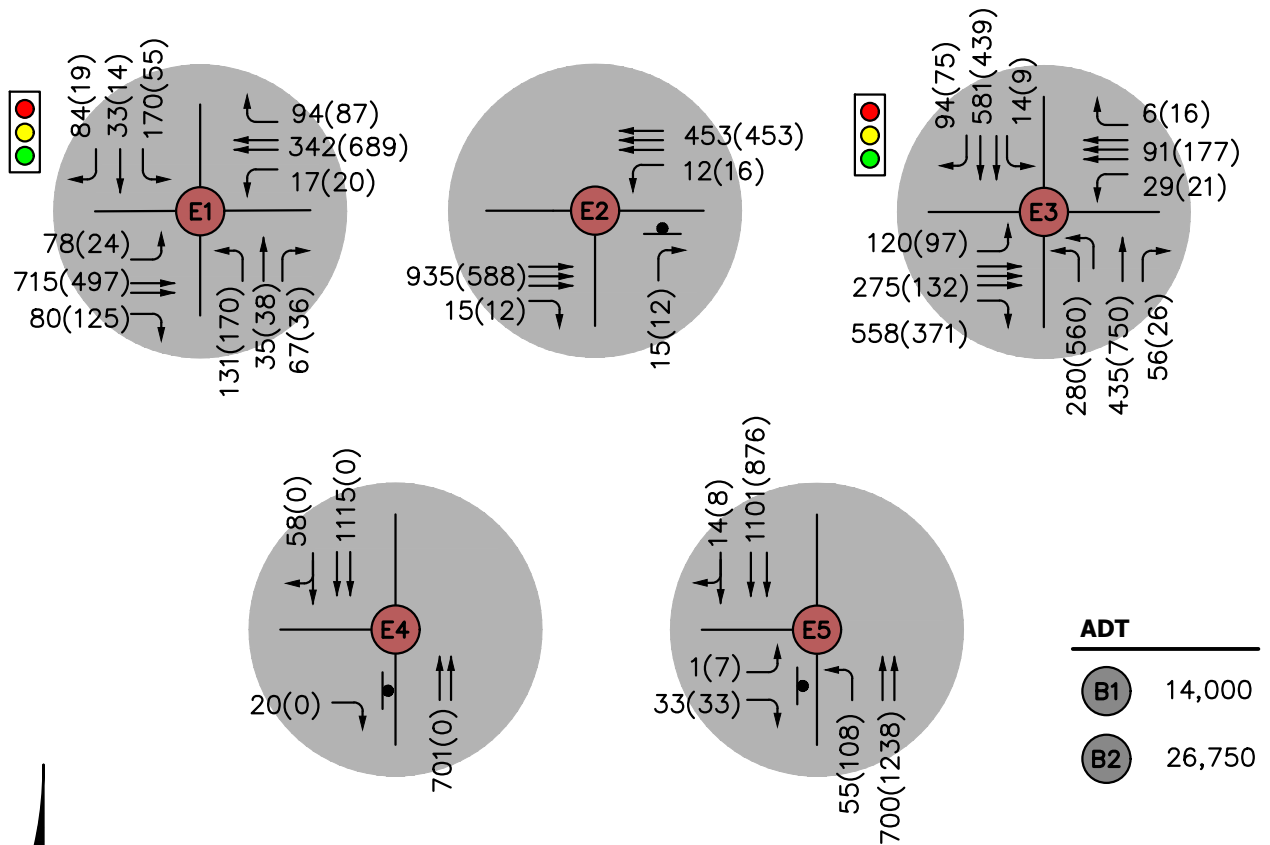

LEGEND

- EXISTING INTERSECTION
- STOP SIGN CONTROL
- AM (PM) PEAK HOUR TRIP DISTRIBUTION
- TRAFFIC SIGNAL
- PROJECT SITE

Background Traffic Projections

Projections for Years 2025 and 2045 peak hour traffic volumes and ADT have been made for the roadway system adjacent to the site in order to have a basis for determining future traffic impacts.

A 3% growth rate was applied to the existing through traffic volumes at the arterial intersection of 104th Avenue & Tower Road (E3). For other movements at arterial intersections, a 2% growth rate was used. Outside of these rates, a growth rate of 1% was used for all other movements. Previously, the major thru growth rate was 4.0% in the adjacent *Reunion Center – South Traffic Impact Study*, prepared by JR Engineering and dated March 6, 2020. However, when applied to the traffic counts collected recently in 2022 and 2023, the 4.0% growth rate resulted in peak hour volumes that are considered too high in Year 2045. In order to align with projections by the DRCOG Focus Travel Model for Year 2050 along Tower Road south of 104th Avenue, the growth rate was adjusted to 3.0%.

Along 104th Avenue west of Tower Road, the total 2045 ADT volume was calculated based on the 2040 ADT taken from the *Reunion Center Master Traffic Impact Study*, prepared by JR Engineering and dated March 6, 2020.

In the Year 2025 and Year 2045, estimated background volume was added to the intersection of Tower Road & E. 103rd Avenue (E5) from the *Reunion Commercial Center Traffic Impact Study*, prepared by JR Engineering and dated August 22, 2023. The Assignment of Site Generated traffic figure is shown in **Figure 6**

Finally, in the Year 2045, estimated traffic volume was added to intersection of 104th Avenue and Walden Street from undeveloped areas between the Reunion Commercial Center site and 96th Avenue as per the *Duet & Commercial Traffic Conformance Letter*, prepared by JR Engineering and dated September 1, 2023. It was assumed that the overall future development would be commercial/retail with a 15% floor area ratio, with the remaining 85% being roadways, drainage infrastructure, and parking lots. The area was broken up into five traffic analysis zones (TAZ's) with future Walden Street and 104th Avenue treated expected to be primary routes. With the 3% growth rate already applied on Tower Road and 104th Avenue thru volumes, it is expected that the traffic generated by these future developments will be accounted for. Therefore, background 2045 traffic from these TAZ's were only applied to the turning movements at 104th & Walden (E1). The Walden Street cross section and traffic volumes should be re-evaluated in the future as the surrounding area developed.

Refer to **Figure 3** and **Figure 4** for the projected background traffic volumes in the Years 2025, and 2045, respectively.



Figure 3 - Year 2025 Background Traffic and Lane Geometry

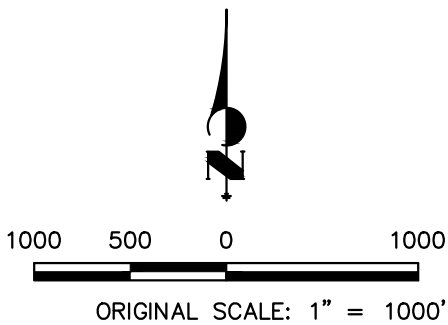
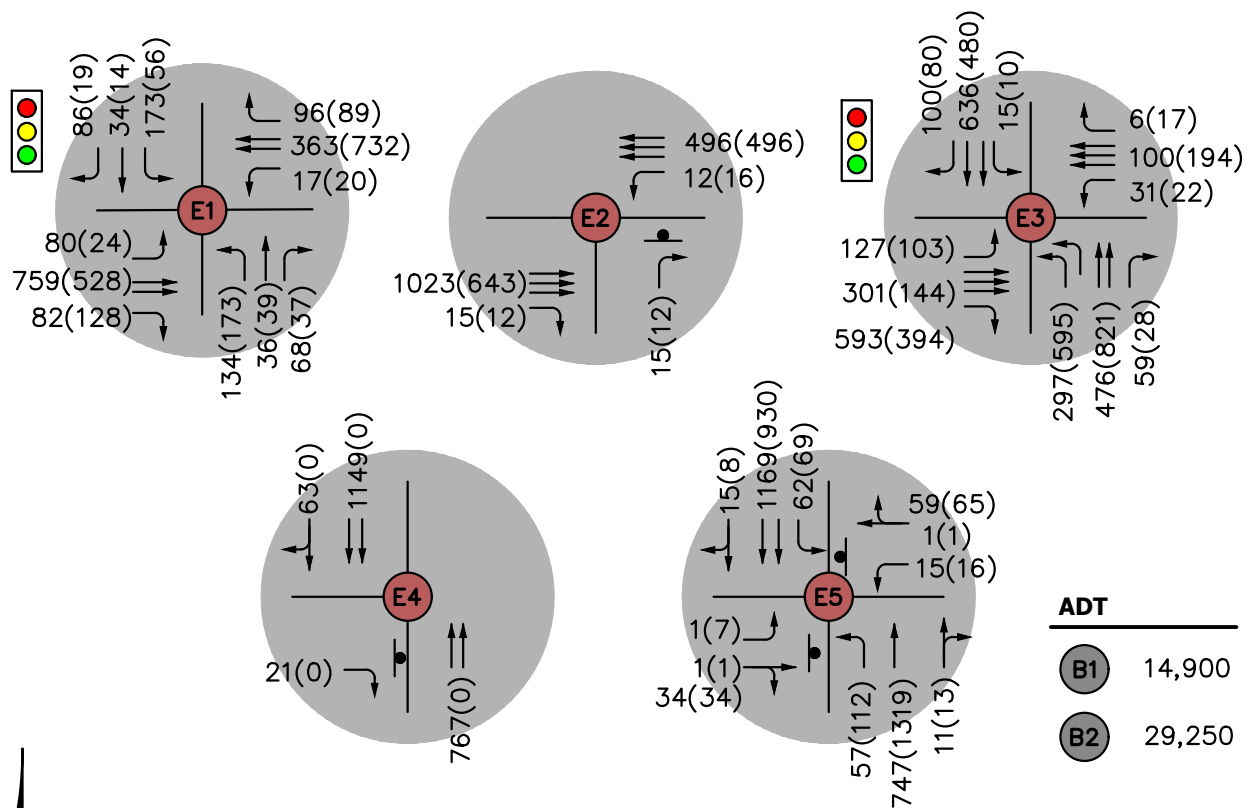

LEGEND

- EXISTING INTERSECTION
- STOP SIGN CONTROL
- TRAFFIC SIGNAL
- PROJECT SITE
- XX (XX) AM (PM) PEAK HOUR TRIP DISTRIBUTION



Figure 4 - Year 2045 Background Traffic and Lane Geometry

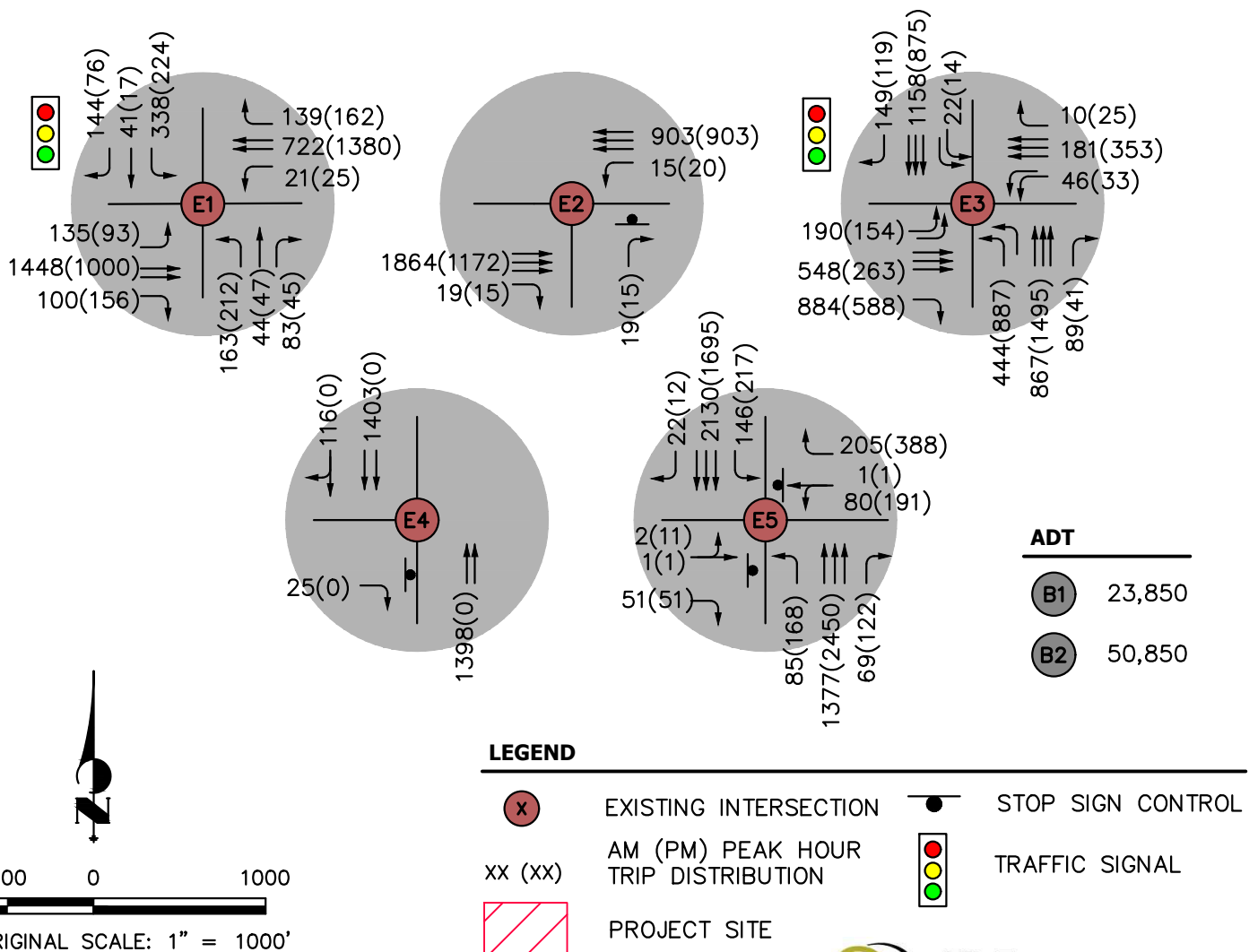

Project Traffic

Trip Generation

Trip generation has been calculated from the latest data contained within the Institute of Transportation Engineers' (ITE) *Trip Generation Manual 10th Edition, 2017*. Based on the land use and the guidelines within the *Trip Generation Manual*, JR used the appropriate fitted curve equation or average rate for the AM peak hour traffic, PM peak hour traffic, and weekday average daily traffic (ADT) for each land use.

Table 1 shows a summary of land use and external vehicle trips generated. Traffic volume reductions were made for internal capture trips along Tower Road and 104th Avenue.

Table 1 – Trip Generation Table

Trip Generation Summary

Alternative: Alternative 1

Phase:

Open Date: 8/28/2023

Project: 103rd Ave & Tower Road Development

Analysis Date: 8/28/2023

ITE	Land Use	Weekday Average Daily Trips			Weekday AM Peak Hour of Adjacent Street Traffic			Weekday PM Peak Hour of Adjacent Street Traffic					
		*	Enter	Exit	Total	*	Enter	Exit	Total	*	Enter	Exit	Total
820	LOT 2 - SHOPPING CENTER 6.13 1000 Sq. Ft. GLA		451	450	901		96	59	155		33	36	69
930	LOT 1 - RESTAURANT 7.6 1000 Sq. Ft. GFA		1198	1197	2395		11	5	16		59	48	107
Unadjusted Volume			1649	1647	3296		107	64	171		92	84	176
Internal Capture Trips			0	0	0		7	7	14		26	26	52
Pass-By Trips			0	0	0		0	0	0		0	0	0
Volume Added to Adjacent Streets			1649	1647	3296		100	57	157		66	58	124

Total Weekday Average Daily Trips Internal Capture = 0 Percent

Total Weekday AM Peak Hour of Adjacent Street Traffic Internal Capture = 8 Percent

Total Weekday PM Peak Hour of Adjacent Street Traffic Internal Capture = 30 Percent

* - Custom rate used for selected time period.

Source: Institute of Transportation Engineers, Trip Generation Manual 10th Edition

In summary, the 104th and Tower Retail and Restaurant Development is expected to generate approximately 3,296 weekday trips, including 171 AM peak hour trips and 178 PM peak hour trips (unadjusted for internal capture and pass-by trips).

The Trip Generation summary, detailed land use reports, and internal capture report are included in **Appendix C**.

Project Trip Distribution

An important element in the determination of the proposed project's traffic impact is the directional distribution of its traffic onto the surrounding roadway system. The relative location of the site, the type of land use, and specific characteristics of the roadway and access system will dictate this distribution of traffic. Note that in this analysis, the distribution was based on the *Reunion Center Master Traffic Impact Study*.

The distribution of the site generated traffic will be oriented as follows:

- 25 percent to the north along Tower Road
 - 5% to the north west on Walden Street and 20% to the north on Tower Road
- 20 percent to the east along 104th Avenue
 - 10% to the northeast on E-470, 10% to the southeast on E-470
- 20 percent to the south along Tower Road
- 35 percent to the west along 104th Avenue

The directional distribution of site generated traffic is shown in **Figure 5**. The site generated traffic was routed through each study intersection based on engineering judgment.

The assignment of site generated traffic for Year 2025 Opening Day and Year 2045 Future Traffic is shown in **Figure 6**.



Total Traffic

For each study year, the site generated traffic was added to the background traffic in order to estimate total traffic. The traffic for Year 2025 Opening Day and Year 2045 Future are shown in **Figure 7** and **Figure 8** with their lane geometries respectively.

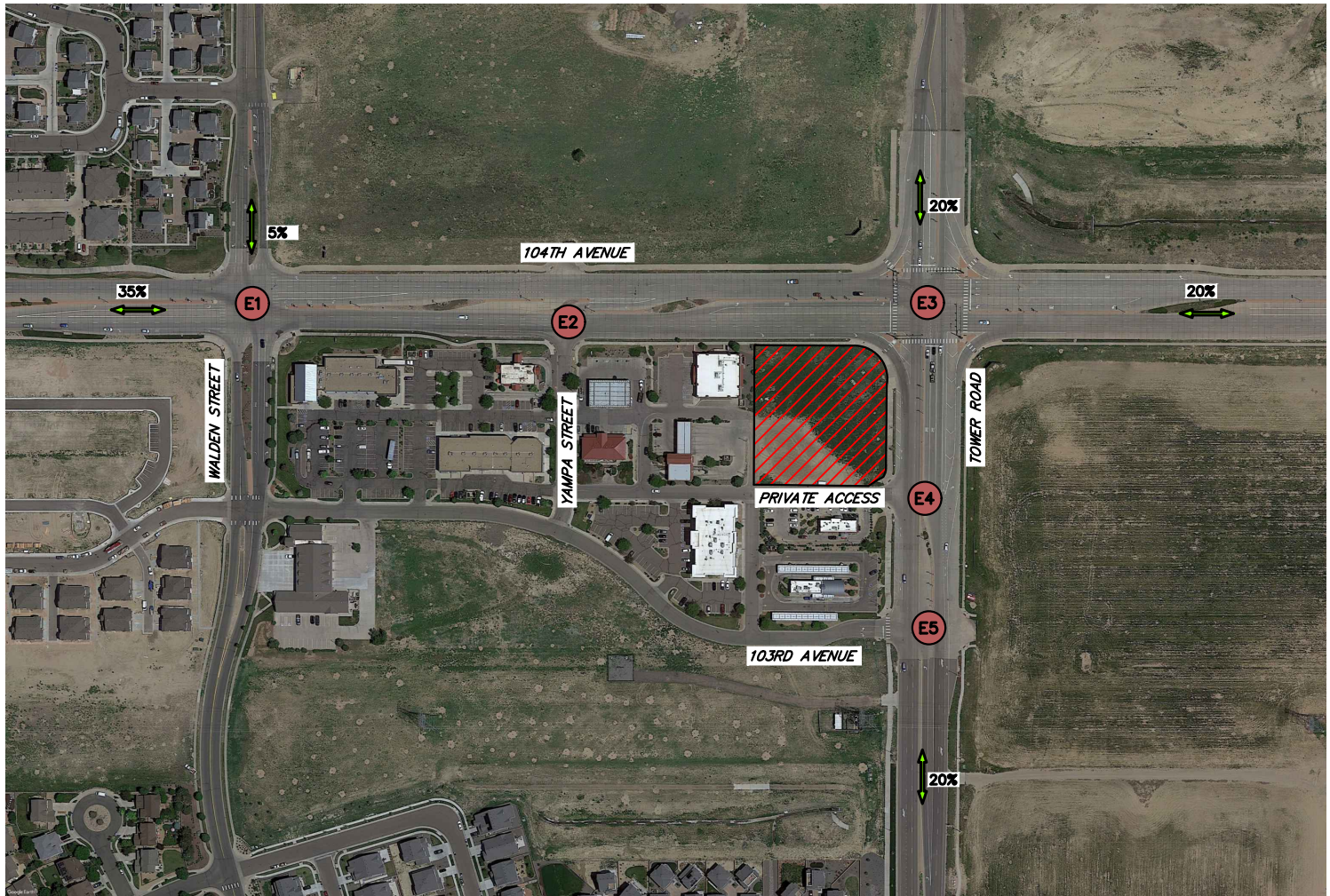
Figure 5 - Directional Distribution of Site Generated Traffic



LEGEND

-  EXISTING INTERSECTION
-  PROJECT SITE



1200 600 0 1200



ORIGINAL SCALE: 1" = 1200'



Figure 6 - Site Generated Traffic

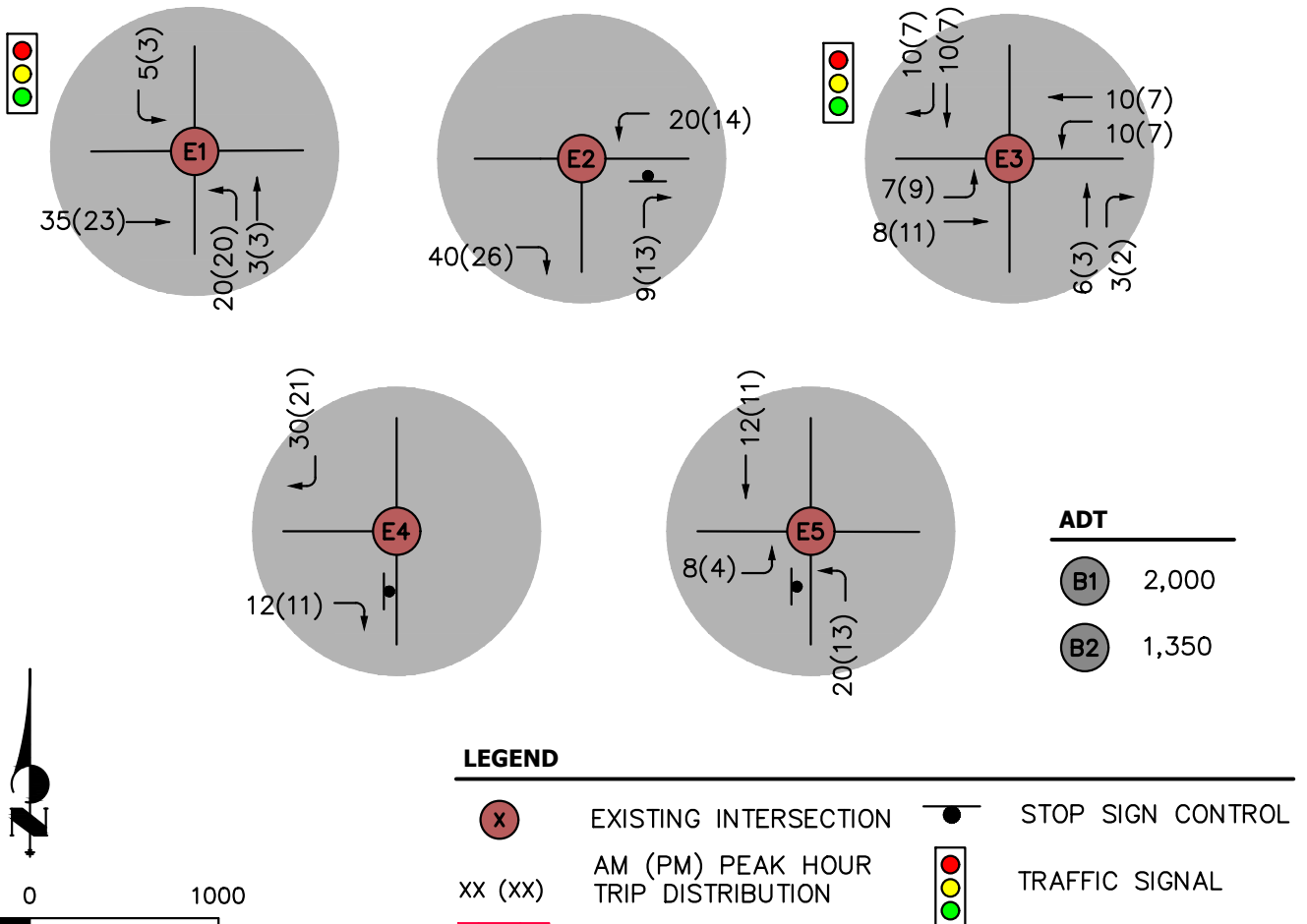

ADT	
B1	2,000
B2	1,350

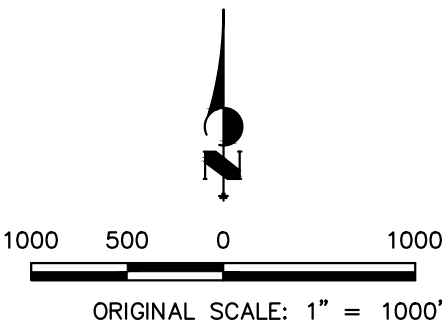

LEGEND

- EXISTING INTERSECTION
- STOP SIGN CONTROL
- TRAFFIC SIGNAL
- XX (XX) AM (PM) PEAK HOUR TRIP DISTRIBUTION
- PROJECT SITE



Figure 7 - Year 2025 Opening Day Traffic

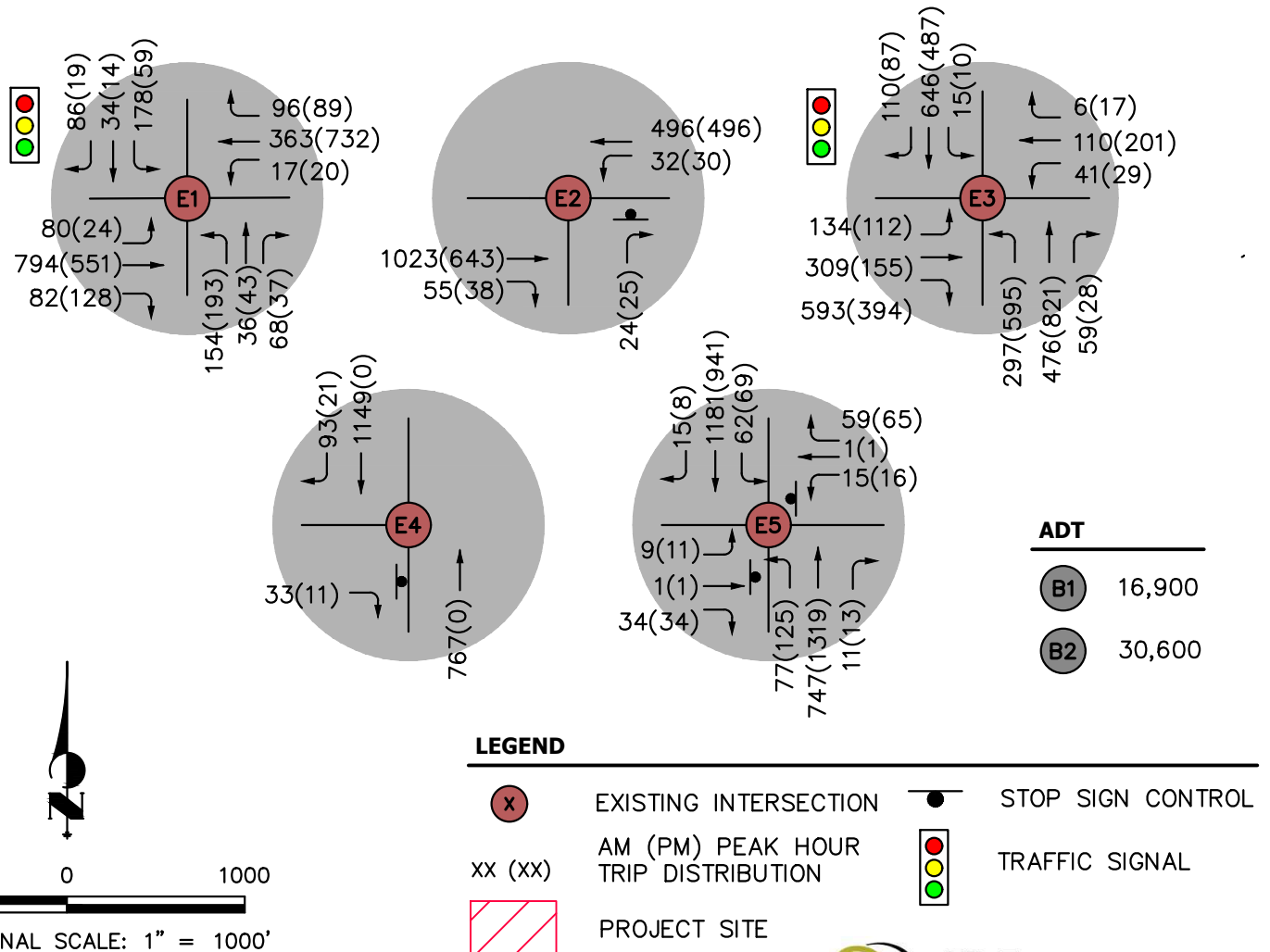
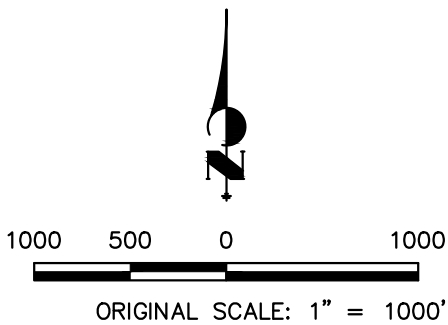
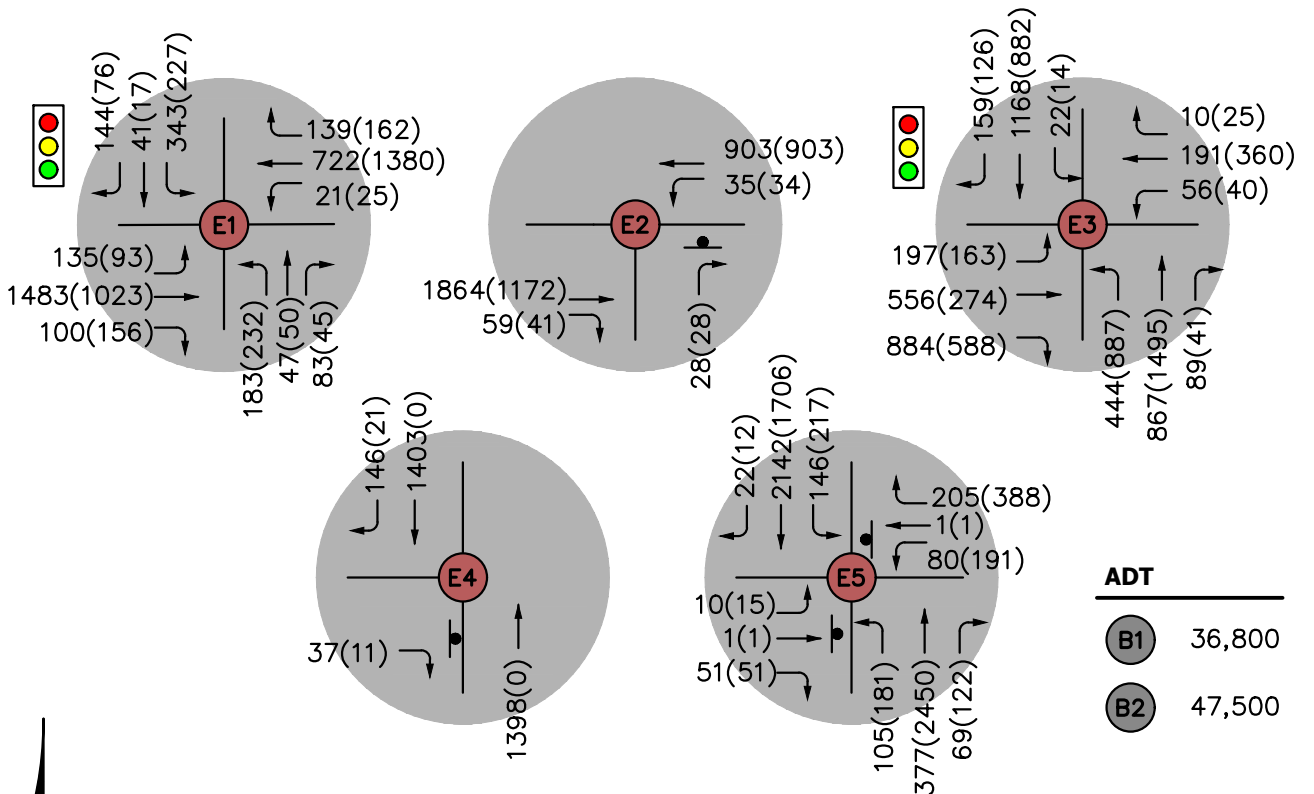



Figure 8 - Year 2045 Total Traffic



Section 3: Traffic Operations and Project Impacts

Level of Service Information

The capacity of an intersection is measured by how well it operates during the peak hours of the day. Intersection capacities are expressed in terms of levels of service (LOS). LOS is a qualitative measure of intersection functionality, which is based on average delay experienced at an intersection. LOS ratings range from LOS A (best – free flow conditions) to LOS F (worst – unstable flow or high vehicle delay).

Signalized Intersections

Level of service for signalized intersections is defined in terms of control delay, which is a measure of driver discomfort, frustration, fuel consumption, and increased travel time. The delay experienced by a motorist is made up of a number of factors that relate to control, geometry, traffic, and incidents. Total delay is the difference between the travel time actually experienced and the reference travel time that would result during base conditions: in the absence of traffic control, geometric delay, any incidents, and any other vehicles. Specifically, LOS criteria for traffic signals are stated in terms of the average control delay per vehicle, typically for a 15-minute analysis period. Delay is a complex measure and depends on a number of variables, including the quality of progression, the cycle length, the green ratio, and the volume to capacity (v/c) ratio for the lane group.

The *Highway Capacity Manual (HCM) 6th Edition* LOS thresholds for lane groups take into account the volume-to-capacity (v/c) ratio, in addition to control delay, such that any value above 1.0 would denote LOS ‘F’ regardless of the corresponding value of control delay. Values for approach and overall intersection LOS are still based on just control delay. **Table 2** lists the LOS thresholds for the automobile mode at a signalized intersection:

**Table 2 – Signalized Intersection
(Auto Mode) LOS Thresholds**

Control Delay (Seconds per Vehicle)	Level of Service (v/c Ratio)	
	<= 1.0	> 1.0
<=10	A	F
>10-20	B	F
>20-35	C	F
>35-55	D	F
>55-80	E	F
>80	F	F

TWSC Intersections

Level of service for a two-way stop controlled (TWSC) intersection is determined by the computed or measured control delay. For motor vehicles, LOS is determined for each minor-street movement (or shared movement) as well as major-street left turns. LOS is not defined for the intersection as a whole or for major-street approaches for three primary reasons:

- a) Major-street through vehicles are assumed to experience zero delay
- b) The disproportionate number of major-street through vehicles at a typical TWSC intersection skews the weighted average for all movements, resulting in a very low overall average delay for all vehicles
- c) The resulting low delay can mask important LOS deficiencies for minor movements

The LOS criteria for TWSC intersections are somewhat different from the criteria used for signalized intersections, primarily because user perceptions differ among transportation facility types. The expectation is that a signalized intersection is designed to carry higher traffic volumes and will present greater delay than an unsignalized intersection. Unsignalized intersections are also associated with more uncertainty for users, as delays are less predictable than they are at signals, which can reduce user's delay tolerance.

As with signalized intersections, LOS F is assigned to the movement if the v/c ratio for the movement exceeds 1.0, regardless of the control delay. **Table 3** lists the LOS thresholds for the automobile mode at a TWSC intersection.

**Table 3 – TWSC Intersection
(Auto Mode) LOS Thresholds**

Control Delay (Seconds per Vehicle)	Level of Service (v/c Ratio)	
	≤ 1.0	> 1.0
0-10	A	F
>10-15	B	F
>15-25	C	F
>25-35	D	F
>35-50	E	F
>50	F	F

Level of Service Results

Traffic analyses of the Existing Condition, Year 2025 Opening Day, and Future Year 2045 were performed using the *HCM 6th Edition*, discussed above. Utilizing the existing traffic volumes and site-generated traffic volumes, the study intersections were analyzed with the *Synchro 11* software. Input data for creating the Synchro network included intersection geometry (number of travel lanes, turning lanes, and lengths of storage bays), traffic control mitigation (speed limits, traffic signals, and stop signs), and vehicular traffic volumes. Operational analyses were conducted in the AM and PM peak hours to determine the levels of service. The lane movement LOS results for each scenario are summarized in **Table 4**, **Table 5**, and **Table 6**. The detailed *HCM 6th Edition* Synchro reports are included in **Appendix D**.

Analysis of Existing Condition

Operational analyses were conducted in the AM and PM peak hours to determine the levels of service. The Year 2022 and Year 2023 existing traffic volumes were input and the level of service results are summarized below.

As shown in **Table 4**, the movements are operating at acceptable levels of service in the existing condition, except for the following:

- (E1) 104th Avenue & Walden Street
 - AM Peak Hour: NBR
- (E3) 104th Avenue & Tower Road
 - AM and PM Peak Hours: NBL and SBL
- (E5) 103rd Avenue & Tower Road
 - AM and PM Peak Hours: EBL

Table 4 – LOS for Year 2023 Existing Condition

Intersection	Minor Lane / Major Movement	Existing Traffic LOS	
		AM Peak Hour	PM Peak Hour
E1 - Walden Street and 104th Avenue	Signalized		
	EBL	B	B
	EBT	B	B
	EBR	B	B
	WBL	B	B
	WBT	C	C
	WBR	C	B
	NBL	D	D
	NBT	D	D
	NBR	E	D
	SBL	D	D
	SBT	D	D
	SBR	D	D
Overall	C	C	
E3 - Tower Road and 104th Avenue	EBL	D	D
	EBT	D	D
	WBL	D	D
	WBT	D	D
	NBL	E	E
	NBT	B	C
	SBL	E	E
	SBT	C	C
	Overall	D	D

TWSC Intersection	Minor Lane / Major Movement	Existing Traffic LOS	
		AM Peak Hour	PM Peak Hour
E2 - 104th Avenue and Yampa Street	WBL	B	B
	NBR	B	B
E4 - Tower Road and Private Access	EBR	C	A
E5 - Tower Road and E. 103rd Avenue	EBL	F	F
	EBR	C	B
	NBL	C	C

Notes:

1. NB=Northbound, SB=Southbound, EB=Eastbound, WB=Westbound
N/A=Not Applicable
2. L=Left, R=Right, T=Through
3. Yellow highlight does not meet Established Threshold of LOS D

Analysis of Year 2025 Opening Day

Intended improvements to the east leg of Tower Road & E. 103rd Avenue are part of the *Reunion Commercial Center Development*. As such, the lane geometry is conveyed in **Figure 3**.

Operational analyses were conducted in the AM and PM peak hours to determine the levels of service. The existing signal timing for Tower & Walden and Tower & 104th was maintained in Year 2025. The projected traffic volumes were input for Year 2025 and the level of service results are summarized below.

As shown in **Table 5**, the movements are expected to operate at acceptable levels of service, except for the following:

- (E1) Walden Street & 104th Avenue
 - AM Peak Hour: NBR
- (E3) Tower Road & 104th Avenue
 - AM and PM Peak Hours: SBL
- (E5) Tower Road & E. 103rd Avenue
 - AM and PM Peak Hours: EBL, WBL
 - PM Peak Hour: EBR

Table 5 – LOS for Year 2025 Traffic

Intersection	Minor Lane / Major Movement	Background Traffic LOS		Opening Day Traffic LOS	
		AM Peak Hour	PM Peak Hour	AM Peak Hour	PM Peak Hour
E1 - Walden Street and 104th Avenue	Signalized				
	EBL	B	B	B	B
	EBT	B	B	B	B
	EBR	B	B	B	B
	WBL	B	B	B	B
	WBT	C	B	C	B
	WBR	C	B	C	B
	NBL	D	D	D	D
	NBT	D	D	D	D
	NBR	E	D	E	D
	SBL	D	D	D	D
	SBT	D	D	D	D
	SBR	D	D	D	D
Overall	C	C	C	C	
E3 - Tower Road and 104th Avenue	EBL	D	D	D	D
	EBT	D	D	D	D
	WBL	D	D	D	D
	WBT	D	D	D	D
	NBL	D	D	D	D
	NBT	B	B	B	B
	SBL	E	E	E	E
	SBT	C	C	C	C
	Overall	C	D	D	D
TWSC Intersection	Minor Lane / Major Movement	Background Traffic LOS		Opening Day Traffic LOS	
		AM Peak Hour	PM Peak Hour	AM Peak Hour	PM Peak Hour
E2 - 104th Avenue and Yampa Street	WBL	C	B	C	B
	NBR	B	B	B	B
E4 - Tower Road and Private Access	EBR	C	A	C	A
E5 - Tower Road and E. 103rd Avenue	NBL	C	C	C	C
	EBL	F	F	F	F
	EBRT	C	D	C	E
	WBL	F	F	F	F
	WBRT	C	D	C	D
SBL	A	B	A	B	

Notes:

- NB=Northbound, SB=Southbound, EB=Eastbound, WB=Westbound
N/A=Not Applicable
- L=Left, R=Right, T=Through
- Yellow highlight does not meet Established Threshold of LOS D

As shown, the above movements are expected to fail in both the Year 2025 Background and Opening Day Traffic conditions. Thus, these failures are not caused by site generated traffic, with the exception of the EBR movement at Tower Road and E. 103rd Avenue (E5) in the PM Peak Hour condition.

JR recommendations are as follows:

- Based on the low volume of left turning traffic, it is not recommended that Tower & 103rd be signalized; a traffic signal is not warranted in Year 2025 per MUTCD Chapter 4C.
- Though the Tower & 103rd signal is not warranted in Year 2025, it is expected to be warranted by the Year 2027 based on the *Reunion Commercial Center Traffic Impact Study*

As shown in **Table 5**, there are no other movements in Year 2025 that are expected to degrade to failure due to the site generated traffic. Therefore, the Restaurant and Retail Development does not generate significant failure on the local transportation system in the Year 2025 Opening Day.

Analysis of Future Year 2045 Future

As per the *Reunion Commercial Center* and *Reunion Center – Duets and Commercial Phase* reports, EBL and SBL dual left turn lanes are expected to be opened at 104th and Tower (E3) by 2027 due to their site generated traffic. As such, the lane geometry is conveyed on **Figure 4**.

The signal timing was optimized in the AM and PM peak hours as needed in order to achieve acceptable LOS. Progression efficiency was not considered for Year 2045 along 104th Avenue, since only two signals are included in this traffic study, but their cycle lengths were matched. The corridor study would need to be updated along 104th Avenue in a future progression analysis.

Operational analyses were conducted in the AM and PM peak hours to determine the levels of service. The projected traffic volumes were input for Year 2045 Future Traffic, and the level of service results are summarized below.

As shown in **Table 6**, the movements are expected to operate at acceptable levels of service in the Future Year 2045, except for the following:

- (E1) Walden Street & 104th Avenue
 - AM Peak Hour: NBR
 - PM Peak Hour: SBR
- (E2) 104th Avenue & Yampa Street
 - AM Peak Hour: WBL
- (E3) Tower Road & 104th Avenue
 - AM and PM Peak Hours: EBL, WBL, and NBL
 - PM Peak Hour: SBL
- (E5) Tower Road & E. 103rd Avenue
 - PM Peak Hour: WBL, WBR, SBL

Table 6 – LOS for Year 2045 Future Traffic

Intersection	Minor Lane / Major Movement	Background Traffic LOS		Future Traffic LOS	
		AM Peak Hour	PM Peak Hour	AM Peak Hour	PM Peak Hour
E1 - Walden Street and 104th Avenue	Signalized				
	EBL	B	B	B	B
	EBT	D	C	D	C
	EBR	B	B	B	B
	WBL	C	B	C	B
	WBT	C	A	C	A
	WBR	C	A	C	A
	NBL	D	D	D	D
	NBT	D	D	D	D
	NBR	E	D	E	D
	SBL	D	D	D	D
	SBT	D	D	D	D
	SBR	D	E	D	E
	Overall	D	B	D	B
E3 - Tower Road and 104th Avenue	EBL	D	E	E	E
	EBT	D	D	D	D
	WBL	E	E	E	E
	WBT	D	D	D	D
	NBL	F	E	F	E
	NBT	B	B	B	B
	SBL	D	E	D	E
	SBT	C	D	C	D
	Overall	D	D	D	D
E5 - Tower Road and E. 103rd Avenue	EBLT	C	D	C	D
	EBR	C	D	C	D
	WBLT	D	E	D	E
	WBR	D	F	D	F
	NBL	B	C	B	C
	NBT	B	D	B	D
	NBR	A	B	A	B
	SBL	B	E	B	E
	SBTR	B	B	B	B
	SBR	A	B	A	B
	Overall	B	D	B	D

TWSC Intersection	Minor Lane / Major Movement	Bakcground Traffic LOS		Future Traffic LOS	
		AM Peak Hour	PM Peak Hour	AM Peak Hour	PM Peak Hour
E2 - 104th Avenue and Yampa Street	WBL	E	C	F	C
	NBR	C	C	D	C
E4 - Tower Road and Private Access	EBR	C	A	C	A

Notes:

1. NB=Northbound, SB=Southbound, EB=Eastbound, WB=Westbound
2. L=Left, R=Right, T=Through
3. Yellow highlight does not meet Established Threshold of LOS D

As shown in **Table 6**, the intersection lane movements between the Year 2045 Background Traffic and Future Traffic are not expected to degrade to a failing level of service, except for the EBL of Tower Road & 104th Avenue in the AM Peak Hour condition. The failing LOS is based on the volume of left turning traffic and the overall volume on Tower. The 95th percentile queues are not expected to block upstream thru lanes.

The 95th percentile queue length for this movement in both the Background AM Peak Hour and Opening Day AM Peak Hour is 89 feet. Therefore, it is recommended that the degraded failure from Background to Opening Day be accepted due to no change in the queue length.

Therefore, 104th and Tower Retail and Restaurant Development does not generate significant failure on the local transportation system in Future Year 2045.

Year 2045 Turn Lane Lengths

A queuing analysis was performed for all left turn lanes controlled by stop signs or traffic signals for the Year 2045 Future Traffic scenario.

- Walden Street and 104th Avenue (E1):
 - EBL: this single left turn lane is existing and extends approximately 500 feet. The 95th percentile queue length is 89 feet in the AM Peak Hour and 82 feet in the PM Peak hour.
 - WBL: this single left turn lane is existing and extends approximately 300 feet. The 95th percentile queue length is 20 feet in the AM Peak Hour and 8 feet in the PM Peak hour.
 - NBL: this single left turn lane is existing and extends approximately 300 feet. The 95th percentile queue length is 181 feet in the AM Peak Hour and 273 feet in the PM Peak hour.
 - SBL: this single left turn lane is existing and extends approximately 300 feet. The 95th percentile queue length is 408 feet in the AM Peak Hour and

254 feet in the PM Peak hour. JR recommends accepting this queue length since traffic is expected to leave a gap within the intersection.

- Yampa Street & 104th Avenue (E2)
 - WBL: this single left turn lane is existing and extends approximately 130 feet. The 95th percentile queue length is 40 feet in the AM Peak Hour and 15 feet in the PM Peak Hour. JR recommends the city accept this failure because the 95th percentile queue length in the AM Peak Hour condition does not create any blockages.
- Tower Road & 104th Avenue (E3):
 - EBL: this single left turn lane is existing and extends approximately 450 feet. The 95th percentile queue length is 119 feet in the AM Peak Hour and 108 in the PM Peak Hour.
 - WBL: this single left turn lane is existing and extends approximately 450 feet. The 95th percentile queue length is 45 feet in the AM Peak hour and 36 in the PM Peak hour.
 - NBL: these dual left turn lanes are existing and extend approximately 320 feet. The 95th percentile queue length is 310 feet in the AM Peak hour and 441 feet in the PM Peak hour and extends into the taper area. JR recommends to monitor the conditions as surrounding development occurs.
 - The NBL could be modified in the future to allow for additional storage. It is expected that the outer left turn lane would be extended to the south of Tower and 103rd (E5) and run along the existing single NBL. With the left turn lane extension, the existing raised median would need to be modified and shifted to the west. Additional signal heads and signage would also be required at the E. 103rd Avenue and Tower Road intersection.
 - SBL: this single left turn lane is existing and extends approximately 360 feet. The 95th percentile queue length is 22 feet in the AM Peak hour and 17 feet in the PM Peak hour
- Tower Road & 103rd Avenue (E5):
 - NBL: this single left turn lane is existing and extends approximately 450 feet. The 95th percentile queue length is 87 feet in the AM Peak hour and 239 feet in the PM Peak Hour
 - SBL: this combined thru and left turn lane is existing and extends approximately 500 feet. The 95th percentile queue length is 85 feet in the AM Peak hour and 295 feet in the PM Peak hour.

Section 4: Conclusion

Based on the analyses presented herein, the following conclusions and recommendations are made with respect to the Reunion Commercial Center proposed development.

Trip Generation, Distribution and Assignment

Trip generation was calculated from the latest data contained within the Institute of Transportation Engineers' (ITE) *Trip Generation Manual 10th Edition*.

In summary, the Year 2025 Opening Day development is expected to generate approximately 3,296 weekday trips, including 171 AM peak hour trips and 176 PM peak hour trips.

The distribution of the site generated traffic was oriented as follows:

- 25 percent to the north along Tower Road
 - 5% to the northwest on Walden Street, 20% to the north on Tower Road
- 20 percent to the east along 104th Avenue
 - 10% to the northeast on E-470, 10% to the southeast on E-470
- 20 percent to the south along Tower Road
- 35 percent to the west along 104th Avenue

Traffic Operations and Project Impacts

Traffic analyses of the Existing Year 2023, Year 2025 Opening Day, and Year 2045 Future conditions were performed using the *HCM 6th Edition* methodologies and *Synchro 11* software.

Year 2023 Existing Condition

The movements are operating at acceptable levels of service in the existing condition, except for the following:

- (E1) Walden Street and 104th Avenue
 - AM Peak Hour: NBR
- (E3) Tower Road and 104th Avenue
 - AM and PM Peak Hours: NBL, SBL
- (E5) Tower Road and E. 103rd Avenue
 - AM and PM Peak Hours: EBL

The Tower and 103rd EBL movement is expected to operate at LOS F in Year 2025. A traffic signal is not expected to be warranted by Year 2025, but is expected to be warranted by the Year 2027 as per the *Reunion Commercial Center Development Traffic Impact Study*.

Year 2025 Opening Day

The movements are not expected to degrade to a failing LOS further from the Year 2025 Background traffic condition except for the following:

- (E5) Tower Road and E. 103rd Avenue

- PM Peak Hour: EBR

As with the Year 2023 Existing Condition, the Tower and 103rd EBL movement is still expected to operate at LOS F in Year 2025. A traffic signal is not expected to be warranted by Year 2025, but is expected to be warranted by the Year 2027 as per the *Reunion Commercial Center Development* Traffic Impact Study. The intersection will need to be evaluated as development occurs.

Year 2045 Future

Between the Year 2045 Background Traffic and Future Traffic, the movements are not expected to degrade to a failing LOS except for the following:

- (E3) Tower Road & 104th Avenue
 - AM Peak Hour: EBL

Recommendations

As mentioned previously, no improvements are needed on adjacent streets with development of the site. The only proposed improvement is a private access to the site. The traffic impacts of 104th and Tower Retail and Restaurant Development can be accommodated by the adjacent roadway network, including both background and site generated traffic, with the following recommendations:

- 103rd Avenue & Tower Road (E5) is expected to be signalized by the Year 2027.
 - Improvements will be made in the *103rd and Tower - Reunion Commercial Center Development* project.
- 104th Avenue & Tower Road (E3) signal phasing should be optimized by the Year 2027 as per the *Reunion Commercial Center Development*, though the cycle length is expected to be maintained. In addition, the 104th Avenue corridor study would need to be updated to alter the cycle length.
 - EBL and SBL dual left turn lanes are expected to be opened by 2027 due to site generated traffic from both *Reunion Commercial Center* and *Reunion Center – Duet and Commercial Phase*.

Intersection sight distance shall be verified at each project site access. This verification shall be done in accordance with the *City of Commerce City Construction Standards and Specifications*, revised December 11, 2017.

JR Engineering trusts that this report will assist with the planning for the proposed developments in the 104th and Tower Retail and Restaurant Development site.

Appendix A Traffic Counts

Peak Hour - All Vehicles

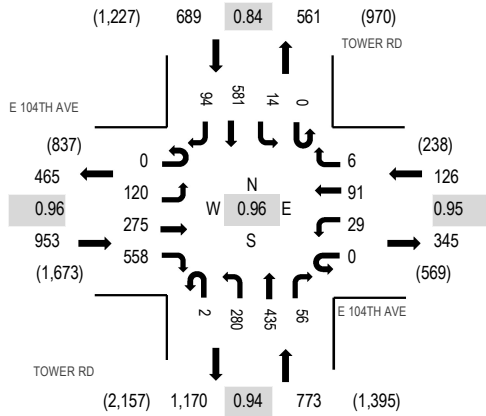

Peak Hour - Pedestrians/Bicycles on Crosswalk

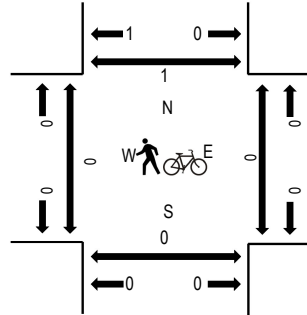

Note: Total study counts contained in parentheses.

Traffic Counts

Interval Start Time	E 104TH AVE Eastbound				E 104TH AVE Westbound				TOWER RD Northbound			TOWER RD Southbound				Total	Rolling Hour	Pedestrian Crossings				
	U-Turn	Left	Thru	Right	U-Turn	Left	Thru	Right	U-Turn	Left	Thru	Right	U-Turn	Left	Thru			Right	West	East	South	North
7:00 AM	0	19	67	155	0	8	15	0	0	57	127	9	0	4	187	13	661	2,541	0	0	0	0
7:15 AM	0	22	65	141	0	4	25	3	0	83	72	14	0	4	167	16	616	2,462	0	0	0	0
7:30 AM	0	38	69	130	0	10	26	0	1	62	122	21	0	4	127	35	645	2,375	0	0	0	0
7:45 AM	0	41	74	132	0	7	25	3	1	78	114	12	0	2	100	30	619	2,201	0	0	0	0
8:00 AM	0	20	65	140	0	10	22	2	0	55	97	15	0	1	139	16	582	1,992	0	0	0	0
8:15 AM	0	15	53	116	0	7	16	1	2	73	101	7	0	1	116	21	529		0	0	0	0
8:30 AM	0	19	31	122	0	7	20	2	0	50	83	11	0	2	113	11	471		0	0	0	0
8:45 AM	0	6	33	100	0	4	21	0	0	60	63	5	0	0	111	7	410		0	0	0	0
Count Total	0	180	457	1,036	0	57	170	11	4	518	779	94	0	18	1,060	149	4,533		0	0	0	0
Peak Hour	0	120	275	558	0	29	91	6	2	280	435	56	0	14	581	94	2,541		0	0	0	0

Location: 4 WALDEN ST & E 104TH AVE AM

Date: Tuesday, August 23, 2022

Peak Hour: 07:15 AM - 08:15 AM

Peak 15-Minutes: 07:45 AM - 08:00 AM

Peak Hour - All Vehicles

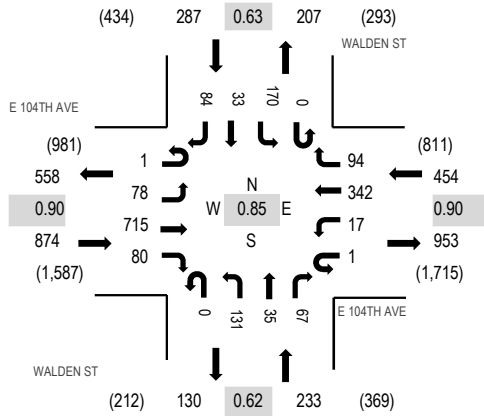

Note: Total study counts contained in parentheses.

Peak Hour - Pedestrians/Bicycles on Crosswalk

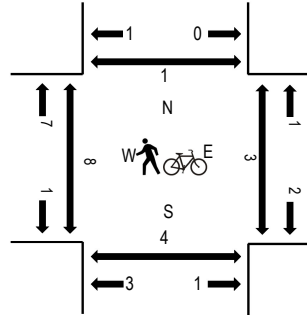

Traffic Counts

Interval Start Time	E 104TH AVE Eastbound				E 104TH AVE Westbound				WALDEN ST Northbound			WALDEN ST Southbound				Total	Rolling Hour	Pedestrian Crossings				
	U-Turn	Left	Thru	Right	U-Turn	Left	Thru	Right	U-Turn	Left	Thru	Right	U-Turn	Left	Thru			Right	West	East	South	North
7:00 AM	0	8	210	6	0	4	74	9	0	20	3	12	0	39	4	15	404	1,788	0	0	0	0
7:15 AM	0	7	160	17	1	3	71	23	0	21	7	11	0	42	5	6	374	1,848	2	3	2	0
7:30 AM	0	19	201	18	0	9	86	29	0	21	3	21	0	38	8	12	465	1,828	3	0	0	0
7:45 AM	0	37	148	24	0	3	95	31	0	53	20	21	0	56	14	43	545	1,671	1	0	0	0
8:00 AM	1	15	206	21	0	2	90	11	0	36	5	14	0	34	6	23	464	1,413	1	0	2	0
8:15 AM	1	10	142	15	0	5	90	15	0	20	7	10	0	26	3	10	354		1	1	3	1
8:30 AM	0	4	153	14	0	5	68	8	0	22	6	4	0	17	1	6	308		1	0	0	0
8:45 AM	0	2	129	19	0	4	67	8	0	22	6	4	0	16	2	8	287		0	0	0	0
Count Total	2	102	1,349	134	1	35	641	134	0	215	57	97	0	268	43	123	3,201		9	4	7	1
Peak Hour	1	78	715	80	1	17	342	94	0	131	35	67	0	170	33	84	1,848		7	3	4	0

Peak Hour - All Vehicles

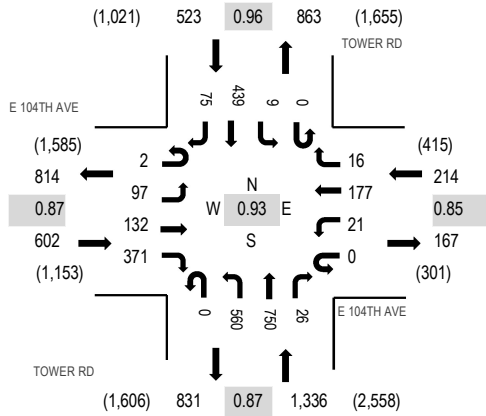

Peak Hour - Pedestrians/Bicycles on Crosswalk

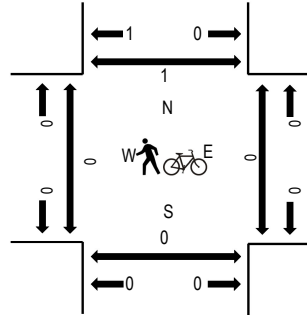

Note: Total study counts contained in parentheses.

Traffic Counts

Interval Start Time	E 104TH AVE Eastbound				E 104TH AVE Westbound				TOWER RD Northbound			TOWER RD Southbound				Total	Rolling Hour	Pedestrian Crossings				
	U-Turn	Left	Thru	Right	U-Turn	Left	Thru	Right	U-Turn	Left	Thru	Right	U-Turn	Left	Thru			Right	West	East	South	North
4:00 PM	0	28	32	80	0	4	47	2	0	160	184	9	0	1	103	22	672	2,508	0	0	0	0
4:15 PM	0	25	23	79	0	12	33	2	0	114	183	6	0	1	81	24	583	2,539	0	0	0	0
4:30 PM	0	26	30	88	0	6	52	2	0	128	170	1	0	1	95	25	624	2,673	0	0	0	0
4:45 PM	1	30	26	79	0	6	48	3	0	129	187	6	0	1	97	16	629	2,675	0	0	0	0
5:00 PM	0	20	30	102	0	5	32	5	0	159	215	9	0	2	108	16	703	2,639	0	0	0	0
5:15 PM	1	35	43	95	0	7	54	5	0	141	185	6	0	6	111	28	717		0	0	0	0
5:30 PM	0	12	33	95	0	3	43	3	0	131	163	5	0	0	123	15	626		0	0	0	1
5:45 PM	0	19	28	93	0	5	34	2	1	115	149	2	0	0	128	17	593		0	0	0	0
Count Total	2	195	245	711	0	48	343	24	1	1,077	1,436	44	0	12	846	163	5,147		0	0	0	1
Peak Hour	2	97	132	371	0	21	177	16	0	560	750	26	0	9	439	75	2,675		0	0	0	1

Peak Hour - All Vehicles

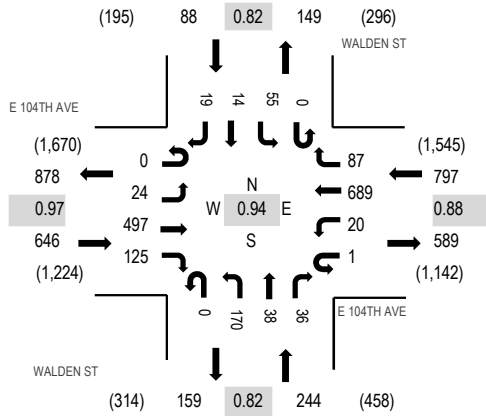

Peak Hour - Pedestrians/Bicycles on Crosswalk

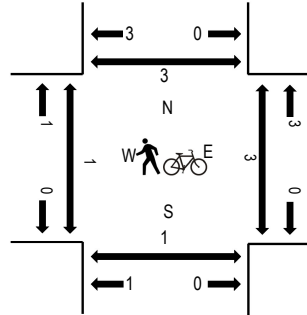

Note: Total study counts contained in parentheses.

Traffic Counts

Interval Start Time	E 104TH AVE Eastbound				E 104TH AVE Westbound				WALDEN ST Northbound				WALDEN ST Southbound				Total	Rolling Hour	Pedestrian Crossings			
	U-Turn	Left	Thru	Right	U-Turn	Left	Thru	Right	U-Turn	Left	Thru	Right	U-Turn	Left	Thru	Right			West	East	South	North
4:00 PM	0	1	131	20	0	7	190	31	0	46	6	10	0	12	4	7	465	1,687	0	2	0	0
4:15 PM	0	4	93	21	0	8	146	22	0	26	12	10	0	11	10	5	368	1,671	0	0	0	0
4:30 PM	0	8	126	33	0	4	186	16	0	43	7	9	0	16	3	2	453	1,775	0	0	0	0
4:45 PM	0	8	115	37	0	6	144	15	0	30	8	11	0	14	3	10	401	1,744	0	0	1	0
5:00 PM	0	1	129	24	1	3	170	26	0	56	13	5	0	15	3	3	449	1,735	1	3	0	3
5:15 PM	0	7	127	31	0	7	189	30	0	41	10	11	0	10	5	4	472		0	0	0	0
5:30 PM	1	6	120	32	0	8	151	26	0	32	6	12	0	17	4	7	422		0	2	0	2
5:45 PM	0	10	110	29	1	8	137	13	0	37	10	7	0	19	4	7	392		0	0	0	0
Count Total	1	45	951	227	2	51	1,313	179	0	311	72	75	0	114	36	45	3,422		1	7	1	5
Peak Hour	0	24	497	125	1	20	689	87	0	170	38	36	0	55	14	19	1,775		1	3	1	3



ALL TRAFFIC DATA SERVICES

(303) 216-2439

www.alltrafficdata.net

Location: 1 TOWER RD & E 103RD AVE AM

Date: Tuesday, July 25, 2023

Peak Hour: 07:15 AM - 08:15 AM

Peak 15-Minutes: 07:30 AM - 07:45 AM

Peak Hour - Motorized Vehicles

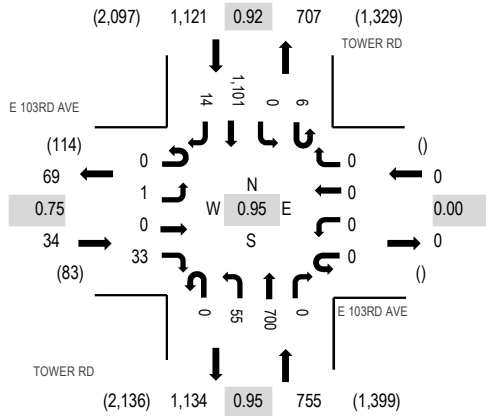

Peak Hour - Bicycles

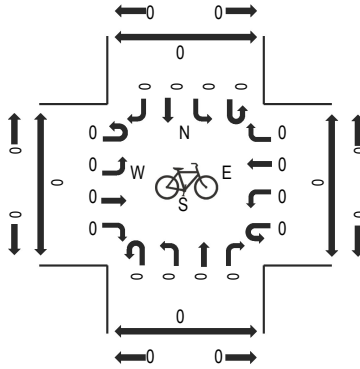

Peak Hour - Pedestrians

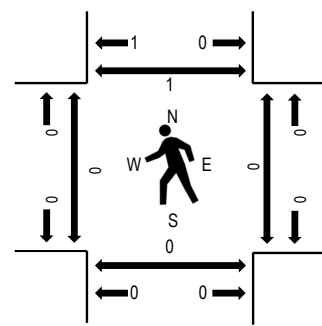

Note: Total study counts contained in parentheses.

Traffic Counts - Motorized Vehicles

Interval Start Time	E 103RD AVE Eastbound				E 103RD AVE Westbound				TOWER RD Northbound				TOWER RD Southbound				Total	Rolling Hour	Pedestrian Crossings			
	U-Turn	Left	Thru	Right	U-Turn	Left	Thru	Right	U-Turn	Left	Thru	Right	U-Turn	Left	Thru	Right			West	East	South	North
7:00 AM	0	0	0	14	0	0	0	0	0	9	154	0	2	0	271	0	450	1,896	0	0	0	0
7:15 AM	0	0	0	6	0	0	0	0	0	10	171	0	4	0	300	2	493	1,910	0	0	0	0
7:30 AM	0	1	0	9	0	0	0	0	0	19	180	0	1	0	287	5	502	1,811	0	0	0	0
7:45 AM	0	0	0	8	0	0	0	0	0	11	185	0	0	0	242	5	451	1,745	0	0	0	0
8:00 AM	0	0	0	10	0	0	0	0	0	15	164	0	1	0	272	2	464	1,683	0	0	0	1
8:15 AM	0	2	0	4	0	0	0	0	0	8	133	0	4	0	240	3	394		1	0	0	1
8:30 AM	0	2	0	13	0	0	0	0	1	7	163	0	4	0	244	2	436		1	0	0	0
8:45 AM	0	1	0	13	0	0	0	0	0	14	155	0	2	0	202	2	389		0	0	0	2
Count Total	0	6	0	77	0	0	0	0	1	93	1,305	0	18	0	2,058	21	3,579		2	0	0	4
Peak Hour	0	1	0	33	0	0	0	0	0	55	700	0	6	0	1,101	14	1,910		0	0	0	1

Peak Hour - Motorized Vehicles

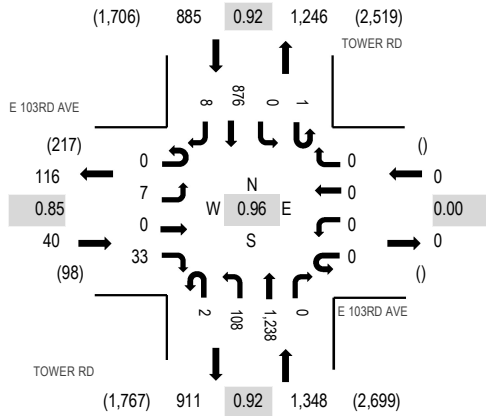

Peak Hour - Bicycles

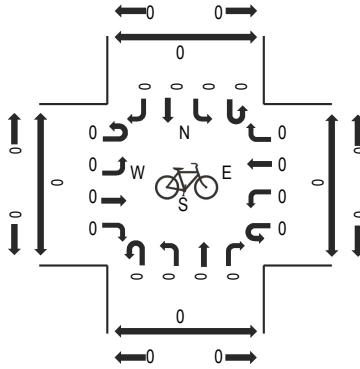

Peak Hour - Pedestrians

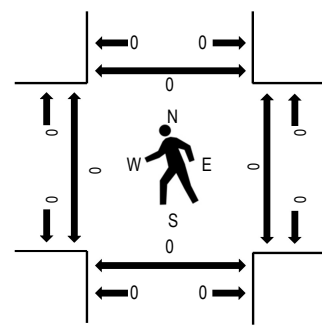

Note: Total study counts contained in parentheses.

Traffic Counts - Motorized Vehicles

























Interval Start Time	E 103RD AVE Eastbound				E 103RD AVE Westbound				TOWER RD Northbound				TOWER RD Southbound				Total	Rolling Hour	Pedestrian Crossings				
	U-Turn	Left	Thru	Right	U-Turn	Left	Thru	Right	U-Turn	Left	Thru	Right	U-Turn	Left	Thru	Right			West	East	South	North	
4:00 PM	0	4	0	13	0	0	0	0	3	18	341	0	0	0	0	206	6	591	2,230	0	0	0	0
4:15 PM	0	2	0	10	0	0	0	0	0	22	308	0	0	0	0	195	4	541	2,216	0	0	0	0
4:30 PM	0	2	0	14	0	0	0	0	0	24	318	0	2	0	0	202	1	563	2,267	0	0	0	0
4:45 PM	0	1	0	12	0	0	0	0	0	23	294	0	1	0	0	201	3	535	2,267	0	0	0	0
5:00 PM	0	2	0	7	0	0	0	0	1	31	295	0	1	0	0	238	2	577	2,273	0	0	0	0
5:15 PM	0	1	0	6	0	0	0	0	0	25	343	0	0	0	0	216	1	592		0	0	0	0
5:30 PM	0	3	0	6	0	0	0	0	0	27	309	0	0	0	0	213	5	563		0	0	0	0
5:45 PM	0	1	0	14	0	0	0	0	1	25	291	0	0	0	0	209	0	541		0	0	0	0
Count Total	0	16	0	82	0	0	0	0	5	195	2,499	0	4	0	0	1,680	22	4,503		0	0	0	0
Peak Hour	0	7	0	33	0	0	0	0	2	108	1,238	0	1	0	0	876	8	2,273		0	0	0	0

Appendix B Traffic Signal Timing

AM Peak Signal Timing Plan
After Implementation

104th Avenue Implemented Signal Timing
 10: Walden St & 104th Ave

AM Peak

												
Lane Group	EBL	EBT	EBR	WBL	WBT	WBR	NBL	NBT	NBR	SBL	SBT	SBR
Lane Configurations												
Traffic Volume (vph)	10	742	42	1	296	44	64	10	26	75	7	18
Future Volume (vph)	10	742	42	1	296	44	64	10	26	75	7	18
Ideal Flow (vphpl)	1900	1900	1900	1900	1900	1900	1900	1900	1900	1900	1900	1900
Storage Length (ft)	400		230	250		0	230		230	210		140
Storage Lanes	1		1	0		1	1		1	1		1
Taper Length (ft)	25			25			25			25		
Lane Util. Factor	1.00	0.95	1.00	1.00	0.95	1.00	1.00	1.00	1.00	1.00	1.00	1.00
Ped Bike Factor	1.00					0.98	1.00					0.99
Fr _t			0.850			0.850			0.850			0.850
Fl _t Protected	0.950			0.950			0.950			0.950		
Satd. Flow (prot)	1805	3406	1538	1805	3406	1583	1770	1727	1615	1805	1900	1615
Fl _t Permitted	0.544			0.328			0.752			0.727		
Satd. Flow (perm)	1031	3406	1538	623	3406	1545	1399	1727	1615	1381	1900	1594
Right Turn on Red			Yes			Yes			Yes			Yes
Satd. Flow (RTOR)			159			159			168			168
Link Speed (mph)		45			45			30				30
Link Distance (ft)		1290			1314			404				2709
Travel Time (s)		19.5			19.9			9.2				61.6
Confl. Peds. (#/hr)	2					2	1					1
Peak Hour Factor	0.94	0.94	0.94	0.86	0.86	0.86	0.93	0.93	0.93	0.93	0.93	0.93
Heavy Vehicles (%)	0%	6%	5%	0%	6%	2%	2%	10%	0%	0%	0%	0%
Adj. Flow (vph)	11	789	45	1	344	51	69	11	28	81	8	19
Shared Lane Traffic (%)												
Lane Group Flow (vph)	11	789	45	1	344	51	69	11	28	81	8	19
Enter Blocked Intersection	No	No	No	No	No	No	No	No	No	No	No	No
Lane Alignment	Left	Left	Right	Left	Left	Right	Left	Left	Right	Left	Left	Right
Median Width(ft)		40			30			24				22
Link Offset(ft)		0			0			0				0
Crosswalk Width(ft)		16			16			16				16
Two way Left Turn Lane												
Headway Factor	1.00	1.00	1.00	1.00	1.00	1.00	1.00	1.00	1.00	1.00	1.00	1.00
Turning Speed (mph)	15		9	15		9	15		9	15		9
Number of Detectors	1	2	1	1	2	1	1	2	1	1	2	1
Detector Template	Left	Thru	Right	Left	Thru	Right	Left	Thru	Right	Left	Thru	Right
Leading Detector (ft)	20	100	20	20	100	20	20	100	20	20	100	20
Trailing Detector (ft)	0	0	0	0	0	0	0	0	0	0	0	0
Detector 1 Position(ft)	0	0	0	0	0	0	0	0	0	0	0	0
Detector 1 Size(ft)	20	6	20	20	6	20	20	6	20	20	6	20
Detector 1 Type	Cl+Ex	Cl+Ex	Cl+Ex	Cl+Ex	Cl+Ex	Cl+Ex	Cl+Ex	Cl+Ex	Cl+Ex	Cl+Ex	Cl+Ex	Cl+Ex
Detector 1 Channel												
Detector 1 Extend (s)	0.0	0.0	0.0	0.0	0.0	0.0	0.0	0.0	0.0	0.0	0.0	0.0
Detector 1 Queue (s)	0.0	0.0	0.0	0.0	0.0	0.0	0.0	0.0	0.0	0.0	0.0	0.0
Detector 1 Delay (s)	0.0	0.0	0.0	0.0	0.0	0.0	0.0	0.0	0.0	0.0	0.0	0.0
Detector 2 Position(ft)		94			94			94				94
Detector 2 Size(ft)		6			6			6				6
Detector 2 Type		Cl+Ex			Cl+Ex			Cl+Ex				Cl+Ex
Detector 2 Channel												
Detector 2 Extend (s)		0.0			0.0			0.0				0.0

104th Avenue Implemented Signal Timing

10: Walden St & 104th Ave

AM Peak



Lane Group	EBL	EBT	EBR	WBL	WBT	WBR	NBL	NBT	NBR	SBL	SBT	SBR
Turn Type	pm+pt	NA	Perm	pm+pt	NA	Perm	pm+pt	NA	Perm	pm+pt	NA	Perm
Protected Phases	5	2		1	6		3	8		7	4	
Permitted Phases	2		2	6		6	8		8	4		4
Detector Phase	5	2	2	1	6	6	3	8	8	7	4	4
Switch Phase												
Minimum Initial (s)	5.0	10.0	10.0	5.0	10.0	10.0	8.0	10.0	10.0	8.0	10.0	10.0
Minimum Split (s)	12.5	36.5	36.5	12.5	36.5	36.5	14.5	42.5	42.5	14.5	42.5	42.5
Total Split (s)	14.0	67.0	67.0	14.0	67.0	67.0	19.0	20.0	20.0	19.0	20.0	20.0
Total Split (%)	11.7%	55.8%	55.8%	11.7%	55.8%	55.8%	15.8%	16.7%	16.7%	15.8%	16.7%	16.7%
Maximum Green (s)	6.5	59.5	59.5	6.5	59.5	59.5	12.5	13.5	13.5	12.5	13.5	13.5
Yellow Time (s)	5.3	5.3	5.3	5.3	5.3	5.3	3.8	3.8	3.8	3.8	3.8	3.8
All-Red Time (s)	2.2	2.2	2.2	2.2	2.2	2.2	2.7	2.7	2.7	2.7	2.7	2.7
Lost Time Adjust (s)	0.0	0.0	0.0	0.0	0.0	0.0	0.0	0.0	0.0	0.0	0.0	0.0
Total Lost Time (s)	7.5	7.5	7.5	7.5	7.5	7.5	6.5	6.5	6.5	6.5	6.5	6.5
Lead/Lag	Lead	Lag	Lag	Lead	Lag	Lag	Lead	Lag	Lag	Lead	Lag	Lag
Lead-Lag Optimize?	Yes	Yes	Yes	Yes	Yes	Yes	Yes	Yes	Yes	Yes	Yes	Yes
Vehicle Extension (s)	3.0	4.0	4.0	3.0	4.0	4.0	3.0	4.0	4.0	3.0	4.0	4.0
Recall Mode	None	C-Max	C-Max	None	C-Max	C-Max	None	None	None	None	None	None
Walk Time (s)		5.0	5.0		5.0	5.0		5.0	5.0		5.0	5.0
Flash Dont Walk (s)		24.0	24.0		24.0	24.0		31.0	31.0		31.0	31.0
Pedestrian Calls (#/hr)		0	0		0	0		0	0		0	0
Act Effct Green (s)	87.5	87.7	87.7	87.2	87.6	87.6	15.9	10.0	10.0	16.4	10.3	10.3
Actuated g/C Ratio	0.73	0.73	0.73	0.73	0.73	0.73	0.13	0.08	0.08	0.14	0.09	0.09
v/c Ratio	0.01	0.32	0.04	0.00	0.14	0.04	0.32	0.08	0.10	0.36	0.05	0.07
Control Delay	3.6	3.6	0.1	3.0	3.4	0.7	44.0	52.2	0.7	45.0	51.3	0.4
Queue Delay	0.0	0.0	0.0	0.0	0.0	0.0	0.0	0.0	0.0	0.0	0.0	0.0
Total Delay	3.6	3.6	0.1	3.0	3.4	0.7	44.0	52.2	0.7	45.0	51.3	0.4
LOS	A	A	A	A	A	A	D	D	A	D	D	A
Approach Delay		3.4			3.0			33.6			37.7	
Approach LOS		A			A			C			D	

Intersection Summary

Area Type:	Other
Cycle Length:	120
Actuated Cycle Length:	120
Offset:	16 (13%), Referenced to phase 2:EBTL and 6:WBTL, Start of Yellow
Natural Cycle:	110
Control Type:	Actuated-Coordinated
Maximum v/c Ratio:	0.36
Intersection Signal Delay:	8.1
Intersection LOS:	A
Intersection Capacity Utilization:	57.0%
ICU Level of Service:	B
Analysis Period (min):	15



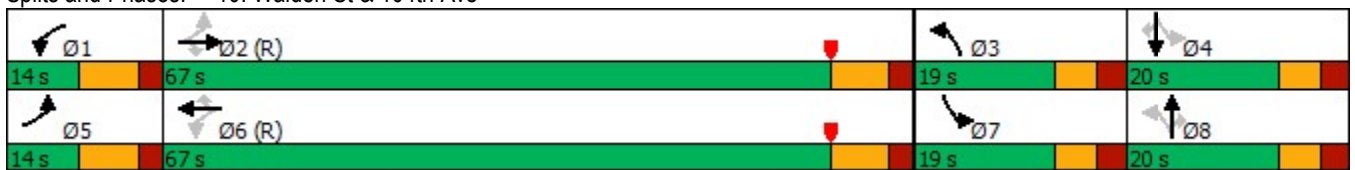



























Splits and Phases: 10: Walden St & 104th Ave



104th Avenue Implemented Signal Timing

11: Tower Rd & 104th Ave

AM Peak

												
Lane Group	EBL	EBT	EBR	WBL	WBT	WBR	NBL	NBT	NBR	SBL	SBT	SBR
Lane Configurations		  			  		 				 	
Traffic Volume (vph)	50	161	583	35	64	3	270	426	23	5	663	40
Future Volume (vph)	50	161	583	35	64	3	270	426	23	5	663	40
Ideal Flow (vphpl)	1900	1900	1900	1900	1900	1900	1900	1900	1900	1900	1900	1900
Storage Length (ft)	350		590	330		440	320		290	290		190
Storage Lanes	1		1	1		1	2		1	1		1
Taper Length (ft)	25			25			25			25		
Lane Util. Factor	1.00	0.91	1.00	1.00	0.91	1.00	0.97	1.00	1.00	1.00	0.95	1.00
Frt			0.850			0.850			0.850			0.850
Flt Protected	0.950			0.950			0.950			0.950		
Satd. Flow (prot)	1736	4848	1538	1467	4803	1615	3367	1743	1162	1504	3406	1538
Flt Permitted	0.693			0.628			0.950			0.950		
Satd. Flow (perm)	1266	4848	1538	970	4803	1615	3367	1743	1162	1504	3406	1538
Right Turn on Red			Yes			Yes			Yes			Yes
Satd. Flow (RTOR)			485			189			182			182
Link Speed (mph)		45			45			45			45	
Link Distance (ft)		1314			579			636			501	
Travel Time (s)		19.9			8.8			9.6			7.6	
Peak Hour Factor	0.85	0.85	0.85	0.71	0.71	0.71	0.93	0.93	0.93	0.94	0.94	0.94
Heavy Vehicles (%)	4%	7%	5%	23%	8%	0%	4%	9%	39%	20%	6%	5%
Adj. Flow (vph)	59	189	686	49	90	4	290	458	25	5	705	43
Shared Lane Traffic (%)												
Lane Group Flow (vph)	59	189	686	49	90	4	290	458	25	5	705	43
Enter Blocked Intersection	No	No	No	No	No	No	No	No	No	No	No	No
Lane Alignment	Left	Left	Right	Left	Left	Right	Left	Left	Right	Left	Left	Right
Median Width(ft)		12			12			24			12	
Link Offset(ft)		0			0			0			0	
Crosswalk Width(ft)		16			16			16			16	
Two way Left Turn Lane												
Headway Factor	1.00	1.00	1.00	1.00	1.00	1.00	1.00	1.00	1.00	1.00	1.00	1.00
Turning Speed (mph)	15		9	15		9	15		9	15		9
Number of Detectors	1	2	1	1	2	1	1	2	1	1	2	1
Detector Template	Left	Thru	Right	Left	Thru	Right	Left	Thru	Right	Left	Thru	Right
Leading Detector (ft)	20	100	20	20	100	20	20	100	20	20	100	20
Trailing Detector (ft)	0	0	0	0	0	0	0	0	0	0	0	0
Detector 1 Position(ft)	0	0	0	0	0	0	0	0	0	0	0	0
Detector 1 Size(ft)	20	6	20	20	6	20	20	6	20	20	6	20
Detector 1 Type	Cl+Ex	Cl+Ex	Cl+Ex	Cl+Ex	Cl+Ex	Cl+Ex	Cl+Ex	Cl+Ex	Cl+Ex	Cl+Ex	Cl+Ex	Cl+Ex
Detector 1 Channel												
Detector 1 Extend (s)	0.0	0.0	0.0	0.0	0.0	0.0	0.0	0.0	0.0	0.0	0.0	0.0
Detector 1 Queue (s)	0.0	0.0	0.0	0.0	0.0	0.0	0.0	0.0	0.0	0.0	0.0	0.0
Detector 1 Delay (s)	0.0	0.0	0.0	0.0	0.0	0.0	0.0	0.0	0.0	0.0	0.0	0.0
Detector 2 Position(ft)		94			94			94			94	
Detector 2 Size(ft)		6			6			6			6	
Detector 2 Type		Cl+Ex			Cl+Ex			Cl+Ex			Cl+Ex	
Detector 2 Channel												
Detector 2 Extend (s)		0.0			0.0			0.0			0.0	
Turn Type	pm+pt	NA	Perm	pm+pt	NA	Perm	Prot	NA	Perm	Prot	NA	Perm
Protected Phases	7	4		3	8		5	2		1	6	

104th Avenue Implemented Signal Timing

11: Tower Rd & 104th Ave

AM Peak



Lane Group	EBL	EBT	EBR	WBL	WBT	WBR	NBL	NBT	NBR	SBL	SBT	SBR
Permitted Phases	4		4	8		8			2			6
Detector Phase	7	4	4	3	8	8	5	2	2	1	6	6
Switch Phase												
Minimum Initial (s)	8.0	10.0	10.0	8.0	10.0	10.0	8.0	10.0	10.0	8.0	10.0	10.0
Minimum Split (s)	15.4	39.4	39.4	15.4	39.4	39.4	16.2	40.2	40.2	16.2	40.2	40.2
Total Split (s)	18.0	38.0	38.0	18.0	38.0	38.0	25.0	39.0	39.0	25.0	39.0	39.0
Total Split (%)	15.0%	31.7%	31.7%	15.0%	31.7%	31.7%	20.8%	32.5%	32.5%	20.8%	32.5%	32.5%
Maximum Green (s)	10.6	30.6	30.6	10.6	30.6	30.6	16.8	30.8	30.8	16.8	30.8	30.8
Yellow Time (s)	5.0	5.0	5.0	5.0	5.0	5.0	5.1	5.1	5.1	5.1	5.1	5.1
All-Red Time (s)	2.4	2.4	2.4	2.4	2.4	2.4	3.1	3.1	3.1	3.1	3.1	3.1
Lost Time Adjust (s)	0.0	0.0	0.0	0.0	0.0	0.0	0.0	0.0	0.0	0.0	0.0	0.0
Total Lost Time (s)	7.4	7.4	7.4	7.4	7.4	7.4	8.2	8.2	8.2	8.2	8.2	8.2
Lead/Lag	Lead	Lag	Lag	Lead	Lag	Lag	Lead	Lag	Lag	Lead	Lag	Lag
Lead-Lag Optimize?	Yes	Yes	Yes	Yes	Yes	Yes	Yes	Yes	Yes	Yes	Yes	Yes
Vehicle Extension (s)	2.0	2.0	2.0	2.0	2.0	2.0	2.0	5.0	5.0	2.0	5.0	5.0
Recall Mode	None	None	None	None	None	None	None	C-Max	C-Max	None	C-Max	C-Max
Walk Time (s)		5.0	5.0		5.0	5.0		5.0	5.0		5.0	5.0
Flash Dont Walk (s)		27.0	27.0		27.0	27.0		27.0	27.0		27.0	27.0
Pedestrian Calls (#/hr)		0	0		0	0		0	0		0	0
Act Effct Green (s)	33.2	26.5	26.5	33.3	26.6	26.6	14.2	62.0	62.0	8.0	42.8	42.8
Actuated g/C Ratio	0.28	0.22	0.22	0.28	0.22	0.22	0.12	0.52	0.52	0.07	0.36	0.36
v/c Ratio	0.15	0.18	0.96	0.16	0.08	0.01	0.73	0.51	0.04	0.05	0.58	0.06
Control Delay	24.6	38.8	51.5	24.5	34.7	0.0	61.8	26.4	0.1	53.6	37.2	0.2
Queue Delay	0.0	0.0	0.0	0.0	0.0	0.0	0.0	0.0	0.0	0.0	0.0	0.0
Total Delay	24.6	38.8	51.5	24.5	34.7	0.0	61.8	26.4	0.1	53.6	37.2	0.2
LOS	C	D	D	C	C	A	E	C	A	D	D	A
Approach Delay		47.3			30.2			38.8			35.2	
Approach LOS		D			C			D			D	

Intersection Summary

Area Type: Other
 Cycle Length: 120
 Actuated Cycle Length: 120
 Offset: 0 (0%), Referenced to phase 2:NBT and 6:SBT, Start of Yellow
 Natural Cycle: 115
 Control Type: Actuated-Coordinated
 Maximum v/c Ratio: 0.96
 Intersection Signal Delay: 40.3
 Intersection LOS: D
 Intersection Capacity Utilization 80.3%
 ICU Level of Service D
 Analysis Period (min) 15

Splits and Phases: 11: Tower Rd & 104th Ave

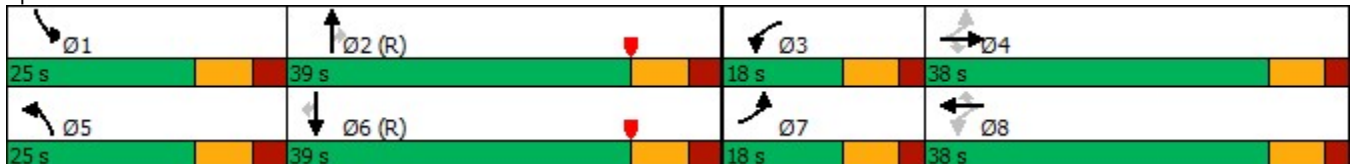

PM Peak Signal Timing Plan
After Implementation

104th Avenue Implemented Signal Timing
 10: Walden St & 104th Ave

PM Peak



Lane Group	EBL	EBT	EBR	WBL	WBT	WBR	NBL	NBT	NBR	SBL	SBT	SBR
Lane Configurations												
Traffic Volume (vph)	33	516	85	32	646	69	160	30	32	68	10	30
Future Volume (vph)	33	516	85	32	646	69	160	30	32	68	10	30
Ideal Flow (vphpl)	1900	1900	1900	1900	1900	1900	1900	1900	1900	1900	1900	1900
Storage Length (ft)	400		230	250		0	230		230	210		140
Storage Lanes	1		1	0		1	1		1	1		1
Taper Length (ft)	25			25			25			25		
Lane Util. Factor	1.00	0.95	1.00	1.00	0.95	1.00	1.00	1.00	1.00	1.00	1.00	1.00
Ped Bike Factor							1.00		0.99	1.00		0.99
Fr _t			0.850			0.850			0.850			0.850
Fl _t Protected	0.950			0.950			0.950			0.950		
Satd. Flow (prot)	1805	3539	1599	1752	3471	1599	1770	1776	1568	1752	1727	1509
Fl _t Permitted	0.332			0.397			0.507			0.732		
Satd. Flow (perm)	631	3539	1599	732	3471	1599	943	1776	1545	1346	1727	1488
Right Turn on Red			Yes			Yes			Yes			Yes
Satd. Flow (RTOR)			159			159			168			168
Link Speed (mph)		45			45			30				30
Link Distance (ft)		1290			1314			404				2709
Travel Time (s)		19.5			19.9			9.2				61.6
Confl. Peds. (#/hr)							2		3	3		2
Peak Hour Factor	0.86	0.86	0.86	0.89	0.89	0.89	0.76	0.76	0.76	0.73	0.73	0.73
Heavy Vehicles (%)	0%	2%	1%	3%	4%	1%	2%	7%	3%	3%	10%	7%
Adj. Flow (vph)	38	600	99	36	726	78	211	39	42	93	14	41
Shared Lane Traffic (%)												
Lane Group Flow (vph)	38	600	99	36	726	78	211	39	42	93	14	41
Enter Blocked Intersection	No	No	No	No	No	No	No	No	No	No	No	No
Lane Alignment	Left	Left	Right	Left	Left	Right	Left	Left	Right	Left	Left	Right
Median Width(ft)		40			30			24				22
Link Offset(ft)		0			0			0				0
Crosswalk Width(ft)		16			16			16				16
Two way Left Turn Lane												
Headway Factor	1.00	1.00	1.00	1.00	1.00	1.00	1.00	1.00	1.00	1.00	1.00	1.00
Turning Speed (mph)	15		9	15		9	15		9	15		9
Number of Detectors	1	2	1	1	2	1	1	2	1	1	2	1
Detector Template	Left	Thru	Right	Left	Thru	Right	Left	Thru	Right	Left	Thru	Right
Leading Detector (ft)	20	100	20	20	100	20	20	100	20	20	100	20
Trailing Detector (ft)	0	0	0	0	0	0	0	0	0	0	0	0
Detector 1 Position(ft)	0	0	0	0	0	0	0	0	0	0	0	0
Detector 1 Size(ft)	20	6	20	20	6	20	20	6	20	20	6	20
Detector 1 Type	Cl+Ex	Cl+Ex	Cl+Ex	Cl+Ex	Cl+Ex	Cl+Ex	Cl+Ex	Cl+Ex	Cl+Ex	Cl+Ex	Cl+Ex	Cl+Ex
Detector 1 Channel												
Detector 1 Extend (s)	0.0	0.0	0.0	0.0	0.0	0.0	0.0	0.0	0.0	0.0	0.0	0.0
Detector 1 Queue (s)	0.0	0.0	0.0	0.0	0.0	0.0	0.0	0.0	0.0	0.0	0.0	0.0
Detector 1 Delay (s)	0.0	0.0	0.0	0.0	0.0	0.0	0.0	0.0	0.0	0.0	0.0	0.0
Detector 2 Position(ft)		94			94			94				94
Detector 2 Size(ft)		6			6			6				6
Detector 2 Type		Cl+Ex			Cl+Ex			Cl+Ex				Cl+Ex
Detector 2 Channel												
Detector 2 Extend (s)		0.0			0.0			0.0				0.0

104th Avenue Implemented Signal Timing

10: Walden St & 104th Ave

PM Peak



Lane Group	EBL	EBT	EBR	WBL	WBT	WBR	NBL	NBT	NBR	SBL	SBT	SBR
Turn Type	pm+pt	NA	Perm	pm+pt	NA	Perm	pm+pt	NA	Perm	pm+pt	NA	Perm
Protected Phases	5	2		1	6		3	8		7	4	
Permitted Phases	2		2	6		6	8		8	4		4
Detector Phase	5	2	2	1	6	6	3	8	8	7	4	4
Switch Phase												
Minimum Initial (s)	5.0	10.0	10.0	5.0	10.0	10.0	8.0	10.0	10.0	8.0	10.0	10.0
Minimum Split (s)	12.5	36.5	36.5	12.5	36.5	36.5	14.5	42.5	42.5	14.5	42.5	42.5
Total Split (s)	14.0	60.0	60.0	14.0	60.0	60.0	23.0	23.0	23.0	23.0	23.0	23.0
Total Split (%)	11.7%	50.0%	50.0%	11.7%	50.0%	50.0%	19.2%	19.2%	19.2%	19.2%	19.2%	19.2%
Maximum Green (s)	6.5	52.5	52.5	6.5	52.5	52.5	16.5	16.5	16.5	16.5	16.5	16.5
Yellow Time (s)	5.3	5.3	5.3	5.3	5.3	5.3	3.8	3.8	3.8	3.8	3.8	3.8
All-Red Time (s)	2.2	2.2	2.2	2.2	2.2	2.2	2.7	2.7	2.7	2.7	2.7	2.7
Lost Time Adjust (s)	0.0	0.0	0.0	0.0	0.0	0.0	0.0	0.0	0.0	0.0	0.0	0.0
Total Lost Time (s)	7.5	7.5	7.5	7.5	7.5	7.5	6.5	6.5	6.5	6.5	6.5	6.5
Lead/Lag	Lead	Lag	Lag	Lead	Lag	Lag	Lead	Lag	Lag	Lead	Lag	Lag
Lead-Lag Optimize?	Yes	Yes	Yes	Yes	Yes	Yes	Yes	Yes	Yes	Yes	Yes	Yes
Vehicle Extension (s)	3.0	4.0	4.0	3.0	4.0	4.0	3.0	4.0	4.0	3.0	4.0	4.0
Recall Mode	None	C-Max	C-Max	None	C-Max	C-Max	None	None	None	None	None	None
Walk Time (s)		5.0	5.0		5.0	5.0		5.0	5.0		5.0	5.0
Flash Dont Walk (s)		24.0	24.0		24.0	24.0		31.0	31.0		31.0	31.0
Pedestrian Calls (#/hr)		0	0		0	0		0	0		0	0
Act Effct Green (s)	72.9	68.7	68.7	72.8	68.6	68.6	27.2	13.8	13.8	19.6	10.0	10.0
Actuated g/C Ratio	0.61	0.57	0.57	0.61	0.57	0.57	0.23	0.12	0.12	0.16	0.08	0.08
v/c Ratio	0.09	0.30	0.10	0.07	0.37	0.08	0.66	0.19	0.13	0.36	0.10	0.15
Control Delay	3.8	5.0	0.3	2.7	9.0	1.4	48.9	50.5	0.8	39.2	52.6	1.1
Queue Delay	0.0	0.0	0.0	0.0	0.0	0.0	0.0	0.0	0.0	0.0	0.0	0.0
Total Delay	3.8	5.0	0.3	2.7	9.0	1.4	48.9	50.5	0.8	39.2	52.6	1.1
LOS	A	A	A	A	A	A	D	D	A	D	D	A
Approach Delay		4.3			8.0			42.2			29.9	
Approach LOS		A			A			D			C	

Intersection Summary

Area Type:	Other
Cycle Length:	120
Actuated Cycle Length:	120
Offset:	6 (5%), Referenced to phase 2:EBTL and 6:WBTL, Start of Yellow
Natural Cycle:	110
Control Type:	Actuated-Coordinated
Maximum v/c Ratio:	0.66
Intersection Signal Delay:	13.2
Intersection LOS:	B
Intersection Capacity Utilization	56.0%
ICU Level of Service	B
Analysis Period (min)	15



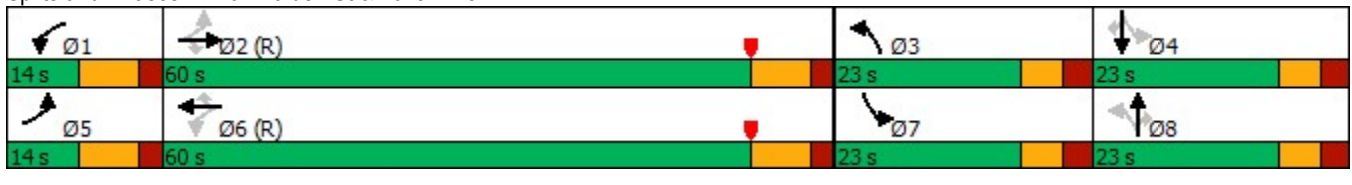



























Splits and Phases: 10: Walden St & 104th Ave



104th Avenue Implemented Signal Timing

11: Tower Rd & 104th Ave

PM Peak

												
Lane Group	EBL	EBT	EBR	WBL	WBT	WBR	NBL	NBT	NBR	SBL	SBT	SBR
Lane Configurations		  			  		 				 	
Traffic Volume (vph)	102	127	405	23	159	9	576	708	22	8	431	67
Future Volume (vph)	102	127	405	23	159	9	576	708	22	8	431	67
Ideal Flow (vphpl)	1900	1900	1900	1900	1900	1900	1900	1900	1900	1900	1900	1900
Storage Length (ft)	350		590	330		440	320		290	290		190
Storage Lanes	1		1	1		1	2		1	1		1
Taper Length (ft)	25			25			25			25		
Lane Util. Factor	1.00	0.91	1.00	1.00	0.91	1.00	0.97	1.00	1.00	1.00	0.95	1.00
Frt			0.850			0.850			0.850			0.850
Flt Protected	0.950			0.950			0.950			0.950		
Satd. Flow (prot)	1787	4940	1583	1597	4759	1615	3433	1827	1417	1805	3406	1599
Flt Permitted	0.513			0.657			0.950			0.950		
Satd. Flow (perm)	965	4940	1583	1105	4759	1615	3433	1827	1417	1805	3406	1599
Right Turn on Red			Yes			Yes			Yes			Yes
Satd. Flow (RTOR)			460			264			182			256
Link Speed (mph)		45			45			45			45	
Link Distance (ft)		1314			579			636			501	
Travel Time (s)		19.9			8.8			9.6			7.6	
Peak Hour Factor	0.88	0.88	0.88	0.92	0.92	0.92	0.97	0.97	0.97	0.92	0.92	0.92
Heavy Vehicles (%)	1%	5%	2%	13%	9%	0%	2%	4%	14%	0%	6%	1%
Adj. Flow (vph)	116	144	460	25	173	10	594	730	23	9	468	73
Shared Lane Traffic (%)												
Lane Group Flow (vph)	116	144	460	25	173	10	594	730	23	9	468	73
Enter Blocked Intersection	No	No	No	No	No	No	No	No	No	No	No	No
Lane Alignment	Left	Left	Right	Left	Left	Right	Left	Left	Right	Left	Left	Right
Median Width(ft)		12			12			24			12	
Link Offset(ft)		0			0			0			0	
Crosswalk Width(ft)		16			16			16			16	
Two way Left Turn Lane												
Headway Factor	1.00	1.00	1.00	1.00	1.00	1.00	1.00	1.00	1.00	1.00	1.00	1.00
Turning Speed (mph)	15		9	15		9	15		9	15		9
Number of Detectors	1	2	1	1	2	1	1	2	1	1	2	1
Detector Template	Left	Thru	Right	Left	Thru	Right	Left	Thru	Right	Left	Thru	Right
Leading Detector (ft)	20	100	20	20	100	20	20	100	20	20	100	20
Trailing Detector (ft)	0	0	0	0	0	0	0	0	0	0	0	0
Detector 1 Position(ft)	0	0	0	0	0	0	0	0	0	0	0	0
Detector 1 Size(ft)	20	6	20	20	6	20	20	6	20	20	6	20
Detector 1 Type	Cl+Ex	Cl+Ex	Cl+Ex	Cl+Ex	Cl+Ex	Cl+Ex	Cl+Ex	Cl+Ex	Cl+Ex	Cl+Ex	Cl+Ex	Cl+Ex
Detector 1 Channel												
Detector 1 Extend (s)	0.0	0.0	0.0	0.0	0.0	0.0	0.0	0.0	0.0	0.0	0.0	0.0
Detector 1 Queue (s)	0.0	0.0	0.0	0.0	0.0	0.0	0.0	0.0	0.0	0.0	0.0	0.0
Detector 1 Delay (s)	0.0	0.0	0.0	0.0	0.0	0.0	0.0	0.0	0.0	0.0	0.0	0.0
Detector 2 Position(ft)		94			94			94			94	
Detector 2 Size(ft)		6			6			6			6	
Detector 2 Type		Cl+Ex			Cl+Ex			Cl+Ex			Cl+Ex	
Detector 2 Channel												
Detector 2 Extend (s)		0.0			0.0			0.0			0.0	
Turn Type	pm+pt	NA	Perm	pm+pt	NA	Perm	Prot	NA	Perm	Prot	NA	Perm
Protected Phases	7	4		3	8		5	2		1	6	

104th Avenue Implemented Signal Timing

11: Tower Rd & 104th Ave

PM Peak



Lane Group	EBL	EBT	EBR	WBL	WBT	WBR	NBL	NBT	NBR	SBL	SBT	SBR
Permitted Phases	4		4	8		8			2			6
Detector Phase	7	4	4	3	8	8	5	2	2	1	6	6
Switch Phase												
Minimum Initial (s)	8.0	10.0	10.0	8.0	10.0	10.0	8.0	10.0	10.0	8.0	10.0	10.0
Minimum Split (s)	15.4	39.4	39.4	15.4	39.4	39.4	16.2	40.2	40.2	16.2	40.2	40.2
Total Split (s)	16.0	32.0	32.0	16.0	32.0	32.0	30.0	55.0	55.0	17.0	42.0	42.0
Total Split (%)	13.3%	26.7%	26.7%	13.3%	26.7%	26.7%	25.0%	45.8%	45.8%	14.2%	35.0%	35.0%
Maximum Green (s)	8.6	24.6	24.6	8.6	24.6	24.6	21.8	46.8	46.8	8.8	33.8	33.8
Yellow Time (s)	5.0	5.0	5.0	5.0	5.0	5.0	5.1	5.1	5.1	5.1	5.1	5.1
All-Red Time (s)	2.4	2.4	2.4	2.4	2.4	2.4	3.1	3.1	3.1	3.1	3.1	3.1
Lost Time Adjust (s)	0.0	0.0	0.0	0.0	0.0	0.0	0.0	0.0	0.0	0.0	0.0	0.0
Total Lost Time (s)	7.4	7.4	7.4	7.4	7.4	7.4	8.2	8.2	8.2	8.2	8.2	8.2
Lead/Lag	Lead	Lag	Lag	Lead	Lag	Lag	Lead	Lag	Lag	Lead	Lag	Lag
Lead-Lag Optimize?	Yes	Yes	Yes	Yes	Yes	Yes	Yes	Yes	Yes	Yes	Yes	Yes
Vehicle Extension (s)	2.0	2.0	2.0	2.0	2.0	2.0	2.0	5.0	5.0	2.0	5.0	5.0
Recall Mode	None	None	None	None	None	None	None	C-Max	C-Max	None	C-Max	C-Max
Walk Time (s)		5.0	5.0		5.0	5.0		5.0	5.0		5.0	5.0
Flash Dont Walk (s)		27.0	27.0		27.0	27.0		27.0	27.0		27.0	27.0
Pedestrian Calls (#/hr)		0	0		0	0		0	0		0	0
Act Effct Green (s)	24.0	18.9	18.9	20.2	12.2	12.2	25.5	73.1	73.1	8.0	42.6	42.6
Actuated g/C Ratio	0.20	0.16	0.16	0.17	0.10	0.10	0.21	0.61	0.61	0.07	0.36	0.36
v/c Ratio	0.46	0.19	0.72	0.11	0.36	0.02	0.82	0.66	0.02	0.07	0.39	0.10
Control Delay	36.0	38.9	25.1	35.4	51.5	0.1	54.4	21.2	0.0	54.0	31.1	0.3
Queue Delay	0.0	0.0	0.0	0.0	0.0	0.0	0.0	0.3	0.0	0.0	0.0	0.0
Total Delay	36.0	38.9	25.1	35.4	51.5	0.1	54.4	21.5	0.0	54.0	31.1	0.3
LOS	D	D	C	D	D	A	D	C	A	D	C	A
Approach Delay		29.6			47.1			35.6			27.4	
Approach LOS		C			D			D			C	

Intersection Summary

Area Type:	Other
Cycle Length:	120
Actuated Cycle Length:	120
Offset:	0 (0%), Referenced to phase 2:NBT and 6:SBT, Start of Yellow
Natural Cycle:	125
Control Type:	Actuated-Coordinated
Maximum v/c Ratio:	0.82
Intersection Signal Delay:	33.3
Intersection LOS:	C
Intersection Capacity Utilization	84.9%
ICU Level of Service	E
Analysis Period (min)	15

Splits and Phases: 11: Tower Rd & 104th Ave



Appendix C Trip Generation Reports

Trip Generation Summary

Alternative: Alternative 1

Phase:

Open Date: 8/28/2023

Project: 103rd Ave & Tower Road Development

Analysis Date: 8/28/2023

ITE	Land Use	Weekday Average Daily Trips			Weekday AM Peak Hour of Adjacent Street Traffic			Weekday PM Peak Hour of Adjacent Street Traffic					
		*	Enter	Exit	Total	*	Enter	Exit	Total	*	Enter	Exit	Total
820	LOT 2 - SHOPPING CENTER 6.13 1000 Sq. Ft. GLA		451	450	901		96	59	155		33	36	69
930	LOT 1 - RESTAURANT 7.6 1000 Sq. Ft. GFA		1198	1197	2395		11	5	16		59	48	107
Unadjusted Volume			1649	1647	3296		107	64	171		92	84	176
Internal Capture Trips			0	0	0		7	7	14		26	26	52
Pass-By Trips			0	0	0		0	0	0		0	0	0
Volume Added to Adjacent Streets			1649	1647	3296		100	57	157		66	58	124

Total Weekday Average Daily Trips Internal Capture = 0 Percent

Total Weekday AM Peak Hour of Adjacent Street Traffic Internal Capture = 8 Percent

Total Weekday PM Peak Hour of Adjacent Street Traffic Internal Capture = 30 Percent

* - Custom rate used for selected time period.

Source: Institute of Transportation Engineers, Trip Generation Manual 10th Edition

TRIP GENERATION 10, TRAFFICWARE, LLC

P. 1

Detailed Land Use Data
 For 7.6 1000 Sq. Ft. GFA of LOT 1 - RESTAURANT
 (930) Fast Casual Restaurant

Open Date: 8/28/2023
 Analysis Date: 8/28/2023

Project: 103rd Ave & Tower Road Development

<u>Day / Period</u>	<u>Total Trips</u>	<u>Pass-By Trips</u>	<u>Avg Rate</u>	<u>Min Rate</u>	<u>Max Rate</u>	<u>Std Dev</u>	<u>Avg Size</u>	<u>% Enter</u>	<u>% Exit</u>	<u>Use Eq.</u>	<u>Equation</u>	<u>R2</u>
Weekday Average Daily Trips Source : Trip Generation Manual 10th Edition	2395	0	315.17	315.17	315.17		3	50	50	False		
Weekday AM Peak Hour of Adjacent Street Traffic Source : Trip Generation Manual 10th Edition	16	0	2.07	2.07	2.07		3	67	33	False		
Weekday PM Peak Hour of Adjacent Street Traffic Source : Trip Generation Manual 10th Edition	107	0	14.13	5.94	34.83	7.72	3	55	45	False		

Detailed Land Use Data

For 6.13 1000 Sq. Ft. GLA of LOT 2 - SHOPPING CENTER
(820) Shopping Center

Open Date: 8/28/2023
Analysis Date: 8/28/2023

Project: 103rd Ave & Tower Road Development

<u>Day / Period</u>	<u>Total Trips</u>	<u>Pass-By Trips</u>	<u>Avg Rate</u>	<u>Min Rate</u>	<u>Max Rate</u>	<u>Std Dev</u>	<u>Avg Size</u>	<u>% Enter</u>	<u>% Exit</u>	<u>Use Eq.</u>	<u>Equation</u>	<u>R2</u>
Weekday Average Daily Trips Source : Trip Generation Manual 10th Edition	901	0	37.75	7.42	207.98	16.41	453	50	50	True	$\ln(T) = 0.68 \ln(X) + 5.57$	0.76
Weekday AM Peak Hour of Adjacent Street Traffic Source : Trip Generation Manual 10th Edition	155	0	0.94	0.18	23.74	0.87	351	62	38	True	$T = 0.5(X) + 151.78$	0.5
Weekday PM Peak Hour of Adjacent Street Traffic Source : Trip Generation Manual 10th Edition	69	0	3.81	0.74	18.69	2.04	327	48	52	True	$\ln(T) = 0.74 \ln(X) + 2.89$	0.82

Internal Capture Report - Alternative 1

AM & PM Peak Hour

Project: 103rd Ave & Tower Road Development

























Open Date: 8/28/2023
Analysis Date: 8/28/2023

AM	Entering Trips				Exiting Trips			
Category	Internal	External	Total	Percent	Internal	External	Total	Percent
Cinema	0	0	0	0%	0	0	0	0%
Hotel	0	0	0	0%	0	0	0	0%
Office	0	0	0	0%	0	0	0	0%
Residential	0	0	0	0%	0	0	0	0%
Restaurant	6	5	11	55%	1	4	5	20%
Retail	1	95	96	1%	6	53	59	10%
All Other Land Uses	0	0	0	0%	0	0	0	0%
Totals	7	100	107	7%	7	57	64	11%

PM	Entering Trips				Exiting Trips			
Category	Internal	External	Total	Percent	Internal	External	Total	Percent
Cinema	0	0	0	0%	0	0	0	0%
Hotel	0	0	0	0%	0	0	0	0%
Office	0	0	0	0%	0	0	0	0%
Residential	0	0	0	0%	0	0	0	0%
Restaurant	10	49	59	17%	16	32	48	33%
Retail	16	17	33	48%	10	26	36	28%
All Other Land Uses	0	0	0	0%	0	0	0	0%
Totals	26	66	92	28%	26	58	84	31%

Appendix D
***HCM 6th Edition* Level of Service Reports**

Lanes, Volumes, Timings
1: Walden Street & 104th Avenue

												
Lane Group	EBL	EBT	EBR	WBL	WBT	WBR	NBL	NBT	NBR	SBL	SBT	SBR
Lane Configurations												
Traffic Volume (vph)	78	715	80	17	342	94	131	35	67	170	33	84
Future Volume (vph)	78	715	80	17	342	94	131	35	67	170	33	84
Ideal Flow (vphpl)	1900	1900	1900	1900	1900	1900	1900	1900	1900	1900	1900	1900
Storage Length (ft)	400		250	250		0	220		220	210		130
Storage Lanes	1		1	1		1	1		1	1		1
Taper Length (ft)	25			25			25			25		
Lane Util. Factor	1.00	0.95	1.00	1.00	0.95	1.00	1.00	1.00	1.00	1.00	1.00	1.00
Frt			0.850			0.850			0.850			0.850
Flt Protected	0.950			0.950			0.950			0.950		
Satd. Flow (prot)	1770	3539	1583	1770	3539	1583	1770	1863	1583	1770	1863	1583
Flt Permitted	0.477			0.323			0.730			0.404		
Satd. Flow (perm)	889	3539	1583	602	3539	1583	1360	1863	1583	753	1863	1583
Right Turn on Red			Yes			Yes			Yes			Yes
Satd. Flow (RTOR)			218			218			227			168
Link Speed (mph)		45			45			30				30
Link Distance (ft)		1000			641			380				215
Travel Time (s)		15.2			9.7			8.6				4.9
Peak Hour Factor	0.80	0.92	0.80	0.78	0.88	0.83	0.84	0.78	0.79	0.84	0.78	0.80
Adj. Flow (vph)	98	777	100	22	389	113	156	45	85	202	42	105
Shared Lane Traffic (%)												
Lane Group Flow (vph)	98	777	100	22	389	113	156	45	85	202	42	105
Enter Blocked Intersection	No	No	No	No	No	No	No	No	No	No	No	No
Lane Alignment	Left	Left	Right	Left	Left	Right	Left	Left	Right	Left	Left	Right
Median Width(ft)		12			12			12				12
Link Offset(ft)		0			0			0				0
Crosswalk Width(ft)		16			16			16				16
Two way Left Turn Lane												
Headway Factor	1.00	1.00	1.00	1.00	1.00	1.00	1.00	1.00	1.00	1.00	1.00	1.00
Turning Speed (mph)	15		9	15		9	15		9	15		9
Number of Detectors	1	1	1	1	1	1	1	1	1	1	1	1
Detector Template	Left	Thru	Right	Left	Thru	Right	Left	Thru	Right	Left	Thru	Right
Leading Detector (ft)	20	100	20	20	100	20	20	100	20	20	100	20
Trailing Detector (ft)	0	0	0	0	0	0	0	0	0	0	0	0
Detector 1 Position(ft)	0	0	0	0	0	0	0	0	0	0	0	0
Detector 1 Size(ft)	20	100	20	20	100	20	20	100	20	20	100	20
Detector 1 Type	Cl+Ex	Cl+Ex	Cl+Ex	Cl+Ex	Cl+Ex	Cl+Ex	Cl+Ex	Cl+Ex	Cl+Ex	Cl+Ex	Cl+Ex	Cl+Ex
Detector 1 Channel												
Detector 1 Extend (s)	0.0	0.0	0.0	0.0	0.0	0.0	0.0	0.0	0.0	0.0	0.0	0.0
Detector 1 Queue (s)	0.0	0.0	0.0	0.0	0.0	0.0	0.0	0.0	0.0	0.0	0.0	0.0
Detector 1 Delay (s)	0.0	0.0	0.0	0.0	0.0	0.0	0.0	0.0	0.0	0.0	0.0	0.0
Turn Type	pm+pt	NA	Perm	pm+pt	NA	Perm	pm+pt	NA	Perm	pm+pt	NA	Perm
Protected Phases	5	2		1	6		3	8		7	4	
Permitted Phases	2		2	6		6	8		8	4		4
Detector Phase	5	2	2	1	6	6	3	8	8	7	4	4
Switch Phase												
Minimum Initial (s)	5.0	10.0	10.0	5.0	10.0	10.0	8.0	10.0	10.0	8.0	10.0	10.0
Minimum Split (s)	12.5	17.5	17.5	12.5	17.5	17.5	14.5	16.5	16.5	14.5	16.5	16.5
Total Split (s)	19.0	50.0	50.0	13.0	44.0	44.0	20.0	17.0	17.0	40.0	37.0	37.0

Lanes, Volumes, Timings
1: Walden Street & 104th Avenue

Lane Group	EBL	EBT	EBR	WBL	WBT	WBR	NBL	NBT	NBR	SBL	SBT	SBR
Total Split (%)	15.8%	41.7%	41.7%	10.8%	36.7%	36.7%	16.7%	14.2%	14.2%	33.3%	30.8%	30.8%
Maximum Green (s)	11.5	42.5	42.5	5.5	36.5	36.5	13.5	10.5	10.5	33.5	30.5	30.5
Yellow Time (s)	5.3	5.3	5.3	5.3	5.3	5.3	3.8	3.8	3.8	3.8	3.8	3.8
All-Red Time (s)	2.2	2.2	2.2	2.2	2.2	2.2	2.7	2.7	2.7	2.7	2.7	2.7
Lost Time Adjust (s)	0.0	0.0	0.0	0.0	0.0	0.0	0.0	0.0	0.0	0.0	0.0	0.0
Total Lost Time (s)	7.5	7.5	7.5	7.5	7.5	7.5	6.5	6.5	6.5	6.5	6.5	6.5
Lead/Lag	Lead	Lag	Lag	Lead	Lag	Lag	Lead	Lag	Lag	Lead	Lag	Lag
Lead-Lag Optimize?	Yes	Yes	Yes	Yes	Yes	Yes	Yes	Yes	Yes	Yes	Yes	Yes
Vehicle Extension (s)	3.0	5.0	5.0	3.0	5.0	5.0	2.0	2.0	2.0	2.0	2.0	2.0
Recall Mode	None	C-Max	C-Max	None	C-Max	C-Max	None	None	None	None	None	None
Act Effct Green (s)	70.6	64.9	64.9	63.6	57.4	57.4	20.1	10.1	10.1	30.9	14.1	14.1
Actuated g/C Ratio	0.59	0.54	0.54	0.53	0.48	0.48	0.17	0.08	0.08	0.26	0.12	0.12
v/c Ratio	0.17	0.41	0.10	0.06	0.23	0.13	0.58	0.29	0.25	0.56	0.19	0.31
Control Delay	11.6	19.1	0.2	3.3	7.1	1.5	44.7	56.8	1.7	41.3	48.2	3.2
Queue Delay	0.0	0.0	0.0	0.0	0.0	0.0	0.0	0.0	0.0	0.0	0.0	0.0
Total Delay	11.6	19.1	0.2	3.3	7.1	1.5	44.7	56.8	1.7	41.3	48.2	3.2
LOS	B	B	A	A	A	A	D	E	A	D	D	A
Approach Delay		16.4			5.8			33.8			30.7	
Approach LOS		B			A			C			C	

Intersection Summary

Area Type:	Other
Cycle Length:	120
Actuated Cycle Length:	120
Offset:	0.7 (1%), Referenced to phase 2:EBTL and 6:WBTL, Start of Yellow
Natural Cycle:	65
Control Type:	Actuated-Coordinated
Maximum v/c Ratio:	0.58
Intersection Signal Delay:	18.5
Intersection LOS:	B
Intersection Capacity Utilization	57.9%
ICU Level of Service	B
Analysis Period (min)	15

Splits and Phases: 1: Walden Street & 104th Avenue

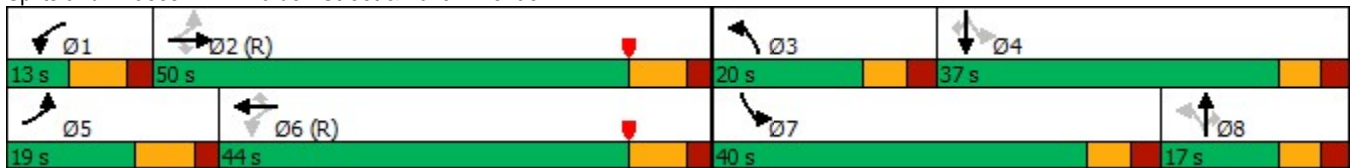

Queues
1: Walden Street & 104th Avenue



Lane Group	EBL	EBT	EBR	WBL	WBT	WBR	NBL	NBT	NBR	SBL	SBT	SBR
Lane Group Flow (vph)	98	777	100	22	389	113	156	45	85	202	42	105
v/c Ratio	0.17	0.41	0.10	0.06	0.23	0.13	0.58	0.29	0.25	0.56	0.19	0.31
Control Delay	11.6	19.1	0.2	3.3	7.1	1.5	44.7	56.8	1.7	41.3	48.2	3.2
Queue Delay	0.0	0.0	0.0	0.0	0.0	0.0	0.0	0.0	0.0	0.0	0.0	0.0
Total Delay	11.6	19.1	0.2	3.3	7.1	1.5	44.7	56.8	1.7	41.3	48.2	3.2
Queue Length 50th (ft)	29	196	0	1	53	0	97	33	0	129	30	0
Queue Length 95th (ft)	54	286	0	m3	70	m0	134	62	0	169	53	0
Internal Link Dist (ft)		920			561			300			135	
Turn Bay Length (ft)	400		250	250			220		220	210		130
Base Capacity (vph)	616	1914	956	378	1693	871	290	163	345	504	473	527
Starvation Cap Reductn	0	0	0	0	0	0	0	0	0	0	0	0
Spillback Cap Reductn	0	0	0	0	0	0	0	0	0	0	0	0
Storage Cap Reductn	0	0	0	0	0	0	0	0	0	0	0	0
Reduced v/c Ratio	0.16	0.41	0.10	0.06	0.23	0.13	0.54	0.28	0.25	0.40	0.09	0.20

Intersection Summary

m Volume for 95th percentile queue is metered by upstream signal.

HCM 6th Signalized Intersection Summary
1: Walden Street & 104th Avenue

JR Engineering
09/20/2023



Movement	EBL	EBT	EBR	WBL	WBT	WBR	NBL	NBT	NBR	SBL	SBT	SBR
Lane Configurations	↘	↗↗	↘	↘	↗↗	↘	↘	↗	↘	↘	↗	↘
Traffic Volume (veh/h)	78	715	80	17	342	94	131	35	67	170	33	84
Future Volume (veh/h)	78	715	80	17	342	94	131	35	67	170	33	84
Initial Q (Qb), veh	0	0	0	0	0	0	0	0	0	0	0	0
Ped-Bike Adj(A_pbT)	1.00		1.00	1.00		1.00	1.00		1.00	1.00		1.00
Parking Bus, Adj	1.00	1.00	1.00	1.00	1.00	1.00	1.00	1.00	1.00	1.00	1.00	1.00
Work Zone On Approach		No			No			No			No	
Adj Sat Flow, veh/h/ln	1870	1870	1870	1870	1870	1870	1870	1870	1870	1870	1870	1870
Adj Flow Rate, veh/h	98	777	100	22	389	113	156	45	85	202	42	105
Peak Hour Factor	0.80	0.92	0.80	0.78	0.88	0.83	0.84	0.78	0.79	0.84	0.78	0.80
Percent Heavy Veh, %	2	2	2	2	2	2	2	2	2	2	2	2
Cap, veh/h	517	1923	858	360	1853	827	333	156	132	351	203	172
Arrive On Green	0.04	0.54	0.54	0.01	0.17	0.17	0.10	0.08	0.08	0.12	0.11	0.11
Sat Flow, veh/h	1781	3554	1585	1781	3554	1585	1781	1870	1585	1781	1870	1585
Grp Volume(v), veh/h	98	777	100	22	389	113	156	45	85	202	42	105
Grp Sat Flow(s),veh/h/ln	1781	1777	1585	1781	1777	1585	1781	1870	1585	1781	1870	1585
Q Serve(g_s), s	3.1	15.4	3.7	0.7	11.3	7.3	9.5	2.7	6.2	12.2	2.5	7.6
Cycle Q Clear(g_c), s	3.1	15.4	3.7	0.7	11.3	7.3	9.5	2.7	6.2	12.2	2.5	7.6
Prop In Lane	1.00		1.00	1.00		1.00	1.00		1.00	1.00		1.00
Lane Grp Cap(c), veh/h	517	1923	858	360	1853	827	333	156	132	351	203	172
V/C Ratio(X)	0.19	0.40	0.12	0.06	0.21	0.14	0.47	0.29	0.64	0.58	0.21	0.61
Avail Cap(c_a), veh/h	614	1923	858	403	1853	827	364	164	139	634	475	403
HCM Platoon Ratio	1.00	1.00	1.00	0.33	0.33	0.33	1.00	1.00	1.00	1.00	1.00	1.00
Upstream Filter(I)	1.00	1.00	1.00	1.00	1.00	1.00	1.00	1.00	1.00	1.00	1.00	1.00
Uniform Delay (d), s/veh	12.7	16.2	13.5	13.6	28.4	26.8	44.4	51.7	53.3	42.9	48.8	51.1
Incr Delay (d2), s/veh	0.2	0.6	0.3	0.1	0.3	0.3	0.4	0.4	6.8	0.6	0.2	1.3
Initial Q Delay(d3),s/veh	0.0	0.0	0.0	0.0	0.0	0.0	0.0	0.0	0.0	0.0	0.0	0.0
%ile BackOfQ(50%),veh/ln	1.2	6.0	1.4	0.3	5.2	3.0	4.2	1.3	2.7	5.4	1.2	3.1
Unsig. Movement Delay, s/veh												
LnGrp Delay(d),s/veh	12.9	16.8	13.8	13.7	28.7	27.1	44.7	52.0	60.1	43.5	49.0	52.4
LnGrp LOS	B	B	B	B	C	C	D	D	E	D	D	D
Approach Vol, veh/h		975			524			286				349
Approach Delay, s/veh		16.1			27.7			50.4				46.8
Approach LOS		B			C			D				D
Timer - Assigned Phs	1	2	3	4	5	6	7	8				
Phs Duration (G+Y+Rc), s	10.1	72.4	17.9	19.5	12.5	70.1	21.0	16.5				
Change Period (Y+Rc), s	* 7.5	* 7.5	6.5	6.5	* 7.5	* 7.5	6.5	6.5				
Max Green Setting (Gmax), s	* 5.5	* 43	13.5	30.5	* 12	* 37	33.5	10.5				
Max Q Clear Time (g_c+I1), s	2.7	17.4	11.5	9.6	5.1	13.3	14.2	8.2				
Green Ext Time (p_c), s	0.0	10.4	0.0	0.3	0.1	5.2	0.3	0.1				

Intersection Summary

HCM 6th Ctrl Delay	28.6
HCM 6th LOS	C

Notes

- User approved pedestrian interval to be less than phase max green.
- * HCM 6th computational engine requires equal clearance times for the phases crossing the barrier.

Lanes, Volumes, Timings
2: Yampa Street & 104th Avenue

	→	↘	↙	←	↖	↗
Lane Group	EBT	EBR	WBL	WBT	NBL	NBR
Lane Configurations	↑↑↑	↑	↓	↑↑↑		↓
Traffic Volume (vph)	935	15	12	453	0	15
Future Volume (vph)	935	15	12	453	0	15
Ideal Flow (vphpl)	1900	1900	1900	1900	1900	1900
Storage Length (ft)		200	140		0	0
Storage Lanes		1	1		0	1
Taper Length (ft)			25		25	
Lane Util. Factor	0.91	1.00	1.00	0.91	1.00	1.00
Frt		0.850				0.865
Flt Protected			0.950			
Satd. Flow (prot)	5085	1583	1770	5085	0	1611
Flt Permitted			0.950			
Satd. Flow (perm)	5085	1583	1770	5085	0	1611
Link Speed (mph)	35			45	30	
Link Distance (ft)	641			1041	275	
Travel Time (s)	12.5			15.8	6.3	
Peak Hour Factor	0.92	0.78	0.78	0.88	0.78	0.78
Adj. Flow (vph)	1016	19	15	515	0	19
Shared Lane Traffic (%)						
Lane Group Flow (vph)	1016	19	15	515	0	19
Enter Blocked Intersection	No	No	No	No	No	No
Lane Alignment	Left	Right	Left	Left	Left	Right
Median Width(ft)	12			12	0	
Link Offset(ft)	0			0	0	
Crosswalk Width(ft)	16			16	16	
Two way Left Turn Lane						
Headway Factor	1.00	1.00	1.00	1.00	1.00	1.00
Turning Speed (mph)		9	15		15	9
Sign Control	Free			Free	Stop	
Intersection Summary						
Area Type:	Other					
Control Type:	Unsignalized					
Intersection Capacity Utilization	28.1%			ICU Level of Service A		
Analysis Period (min)	15					

Intersection						
Int Delay, s/veh	0.3					
Movement	EBT	EBR	WBL	WBT	NBL	NBR
Lane Configurations	↑↑↑	↑	↑	↑↑↑		↑
Traffic Vol, veh/h	935	15	12	453	0	15
Future Vol, veh/h	935	15	12	453	0	15
Conflicting Peds, #/hr	0	0	0	0	0	0
Sign Control	Free	Free	Free	Free	Stop	Stop
RT Channelized	-	None	-	None	-	None
Storage Length	-	200	140	-	-	0
Veh in Median Storage, #	0	-	-	0	0	-
Grade, %	0	-	-	0	0	-
Peak Hour Factor	92	78	78	88	78	78
Heavy Vehicles, %	2	2	2	2	2	2
Mvmt Flow	1016	19	15	515	0	19

Major/Minor	Major1	Major2	Minor1	Minor2	Minor3
Conflicting Flow All	0	0	1035	0	508
Stage 1	-	-	-	-	-
Stage 2	-	-	-	-	-
Critical Hdwy	-	-	5.34	-	7.14
Critical Hdwy Stg 1	-	-	-	-	-
Critical Hdwy Stg 2	-	-	-	-	-
Follow-up Hdwy	-	-	3.12	-	3.92
Pot Cap-1 Maneuver	-	-	376	-	437
Stage 1	-	-	-	-	0
Stage 2	-	-	-	-	0
Platoon blocked, %	-	-	-	-	-
Mov Cap-1 Maneuver	-	-	376	-	437
Mov Cap-2 Maneuver	-	-	-	-	-
Stage 1	-	-	-	-	-
Stage 2	-	-	-	-	-

Approach	EB	WB	NB
HCM Control Delay, s	0	0.4	13.6
HCM LOS			B

Minor Lane/Major Mvmt	NBLn1	EBT	EBR	WBL	WBT
Capacity (veh/h)	437	-	-	376	-
HCM Lane V/C Ratio	0.044	-	-	0.041	-
HCM Control Delay (s)	13.6	-	-	15	-
HCM Lane LOS	B	-	-	B	-
HCM 95th %tile Q(veh)	0.1	-	-	0.1	-

Lanes, Volumes, Timings
3: Tower Road & 104th Avenue

Lane Group	EBL	EBT	EBR	WBL	WBT	WBR	NBL	NBT	NBR	SBL	SBT	SBR
Lane Configurations												
Traffic Volume (vph)	120	275	558	29	91	6	280	435	56	14	581	94
Future Volume (vph)	120	275	558	29	91	6	280	435	56	14	581	94
Ideal Flow (vphpl)	1900	1900	1900	1900	1900	1900	1900	1900	1900	1900	1900	1900
Storage Length (ft)	350		590	330		440	320		290	290		190
Storage Lanes	1		1	1		1	2		1	1		1
Taper Length (ft)	25			25			25			25		
Lane Util. Factor	1.00	0.91	1.00	1.00	0.91	1.00	0.97	1.00	1.00	1.00	0.95	1.00
Frt			0.850			0.850			0.850			0.850
Flt Protected	0.950			0.950			0.950			0.950		
Satd. Flow (prot)	1770	5085	1583	1770	5085	1583	3433	1863	1583	1770	3539	1583
Flt Permitted	0.537			0.554			0.950			0.950		
Satd. Flow (perm)	1000	5085	1583	1032	5085	1583	3433	1863	1583	1770	3539	1583
Right Turn on Red			Yes			Yes			Yes			Yes
Satd. Flow (RTOR)			499			189			182			182
Link Speed (mph)		45			45			50				50
Link Distance (ft)		1041			151			380				500
Travel Time (s)		15.8			2.3			5.2				6.8
Peak Hour Factor	0.83	0.88	0.92	0.78	0.80	0.78	0.88	0.88	0.78	0.78	0.92	0.80
Adj. Flow (vph)	145	313	607	37	114	8	318	494	72	18	632	118
Shared Lane Traffic (%)												
Lane Group Flow (vph)	145	313	607	37	114	8	318	494	72	18	632	118
Enter Blocked Intersection	No	No	No	No	No	No	No	No	No	No	No	No
Lane Alignment	Left	Left	Right	Left	Left	Right	Left	Left	Right	Left	Left	Right
Median Width(ft)		12			12			24				24
Link Offset(ft)		0			0			0				0
Crosswalk Width(ft)		16			16			16				16
Two way Left Turn Lane												
Headway Factor	1.00	1.00	1.00	1.00	1.00	1.00	1.00	1.00	1.00	1.00	1.00	1.00
Turning Speed (mph)	15		9	15		9	15		9	15		9
Number of Detectors	1	1	1	1	1	1	1	1	1	1	1	1
Detector Template	Left	Thru	Right	Left	Thru	Right	Left	Thru	Right	Left	Thru	Right
Leading Detector (ft)	40	40	40	40	40	40	40	40	40	40	40	40
Trailing Detector (ft)	0	0	0	0	0	0	0	0	0	0	0	0
Detector 1 Position(ft)	0	0	0	0	0	0	0	0	0	0	0	0
Detector 1 Size(ft)	40	40	40	40	40	40	40	40	40	40	40	40
Detector 1 Type	Cl+Ex	Cl+Ex	Cl+Ex	Cl+Ex	Cl+Ex	Cl+Ex	Cl+Ex	Cl+Ex	Cl+Ex	Cl+Ex	Cl+Ex	Cl+Ex
Detector 1 Channel												
Detector 1 Extend (s)	0.0	0.0	0.0	0.0	0.0	0.0	0.0	0.0	0.0	0.0	0.0	0.0
Detector 1 Queue (s)	0.0	0.0	0.0	0.0	0.0	0.0	0.0	0.0	0.0	0.0	0.0	0.0
Detector 1 Delay (s)	0.0	0.0	0.0	0.0	0.0	0.0	0.0	0.0	0.0	0.0	0.0	0.0
Turn Type	pm+pt	NA	Perm	pm+pt	NA	Perm	Prot	NA	Perm	Prot	NA	Perm
Protected Phases	7	4		3	8		5	2		1	6	
Permitted Phases	4		4	8		8			2			6
Detector Phase	7	4	4	3	8	8	5	2	2	1	6	6
Switch Phase												
Minimum Initial (s)	8.0	10.0	10.0	8.0	10.0	10.0	8.0	10.0	10.0	8.0	10.0	10.0
Minimum Split (s)	15.4	39.4	39.4	15.4	39.4	39.4	16.2	40.2	40.2	16.2	40.2	40.2
Total Split (s)	18.0	38.0	38.0	18.0	38.0	38.0	25.0	39.0	39.0	25.0	39.0	39.0

Lanes, Volumes, Timings
3: Tower Road & 104th Avenue



Lane Group	EBL	EBT	EBR	WBL	WBT	WBR	NBL	NBT	NBR	SBL	SBT	SBR
Total Split (%)	15.0%	31.7%	31.7%	15.0%	31.7%	31.7%	20.8%	32.5%	32.5%	20.8%	32.5%	32.5%
Maximum Green (s)	10.6	30.6	30.6	10.6	30.6	30.6	16.8	30.8	30.8	16.8	30.8	30.8
Yellow Time (s)	5.0	5.0	5.0	5.0	5.0	5.0	5.1	5.1	5.1	5.1	5.1	5.1
All-Red Time (s)	2.4	2.4	2.4	2.4	2.4	2.4	3.1	3.1	3.1	3.1	3.1	3.1
Lost Time Adjust (s)	0.0	0.0	0.0	0.0	0.0	0.0	0.0	0.0	0.0	0.0	0.0	0.0
Total Lost Time (s)	7.4	7.4	7.4	7.4	7.4	7.4	8.2	8.2	8.2	8.2	8.2	8.2
Lead/Lag	Lead	Lag	Lag	Lead	Lag	Lag	Lead	Lag	Lag	Lead	Lag	Lag
Lead-Lag Optimize?	Yes	Yes	Yes	Yes	Yes	Yes	Yes	Yes	Yes	Yes	Yes	Yes
Vehicle Extension (s)	2.0	2.0	2.0	2.0	2.0	2.0	2.0	5.0	5.0	2.0	5.0	5.0
Recall Mode	None	None	None	None	None	None	None	C-Min	C-Min	None	C-Min	C-Min
Act Effct Green (s)	32.1	25.7	25.7	25.4	17.4	17.4	14.8	63.0	63.0	8.0	46.4	46.4
Actuated g/C Ratio	0.27	0.21	0.21	0.21	0.14	0.14	0.12	0.52	0.52	0.07	0.39	0.39
v/c Ratio	0.44	0.29	0.83	0.14	0.15	0.02	0.75	0.51	0.08	0.15	0.46	0.16
Control Delay	32.8	38.7	30.5	28.6	42.8	0.2	62.2	25.3	0.2	56.0	31.2	1.2
Queue Delay	0.0	0.0	0.0	0.0	0.0	0.0	0.0	0.0	0.0	0.0	0.0	0.0
Total Delay	32.8	38.7	30.5	28.6	42.8	0.2	62.2	25.3	0.2	56.0	31.2	1.2
LOS	C	D	C	C	D	A	E	C	A	E	C	A
Approach Delay		33.2			37.4			36.5			27.2	
Approach LOS		C			D			D			C	

Intersection Summary

Area Type:	Other
Cycle Length:	120
Actuated Cycle Length:	120
Offset: 0 (0%), Referenced to phase 2:NBT and 6:SBT, Start of Yellow, Master Intersection	
Natural Cycle:	115
Control Type:	Actuated-Coordinated
Maximum v/c Ratio:	0.83
Intersection Signal Delay:	32.8
Intersection LOS:	C
Intersection Capacity Utilization	76.4%
ICU Level of Service	D
Analysis Period (min)	15

Splits and Phases: 3: Tower Road & 104th Avenue

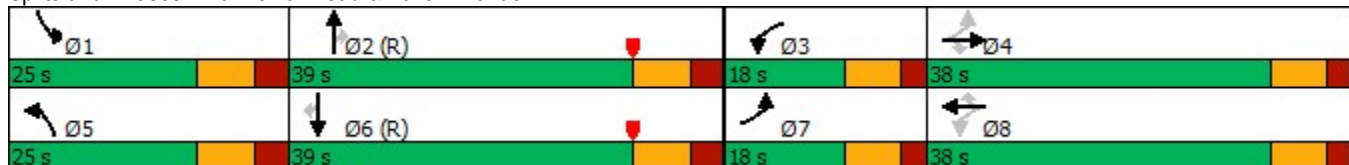































Queues
3: Tower Road & 104th Avenue



Lane Group	EBL	EBT	EBR	WBL	WBT	WBR	NBL	NBT	NBR	SBL	SBT	SBR
Lane Group Flow (vph)	145	313	607	37	114	8	318	494	72	18	632	118
v/c Ratio	0.44	0.29	0.83	0.14	0.15	0.02	0.75	0.51	0.08	0.15	0.46	0.16
Control Delay	32.8	38.7	30.5	28.6	42.8	0.2	62.2	25.3	0.2	56.0	31.2	1.2
Queue Delay	0.0	0.0	0.0	0.0	0.0	0.0	0.0	0.0	0.0	0.0	0.0	0.0
Total Delay	32.8	38.7	30.5	28.6	42.8	0.2	62.2	25.3	0.2	56.0	31.2	1.2
Queue Length 50th (ft)	98	86	227	22	29	0	123	194	0	13	183	0
Queue Length 95th (ft)	123	101	416	34	36	0	167	470	0	33	300	0
Internal Link Dist (ft)		961			71			300			420	
Turn Bay Length (ft)	350		590	330		440	320		290	290		190
Base Capacity (vph)	335	1318	780	305	1296	544	482	977	917	247	1369	724
Starvation Cap Reductn	0	0	0	0	0	0	0	0	0	0	0	0
Spillback Cap Reductn	0	0	0	0	0	0	0	0	0	0	0	0
Storage Cap Reductn	0	0	0	0	0	0	0	0	0	0	0	0
Reduced v/c Ratio	0.43	0.24	0.78	0.12	0.09	0.01	0.66	0.51	0.08	0.07	0.46	0.16

Intersection Summary

HCM 6th Signalized Intersection Summary
3: Tower Road & 104th Avenue

												
Movement	EBL	EBT	EBR	WBL	WBT	WBR	NBL	NBT	NBR	SBL	SBT	SBR
Lane Configurations		  			  		 				 	
Traffic Volume (veh/h)	120	275	558	29	91	6	280	435	56	14	581	94
Future Volume (veh/h)	120	275	558	29	91	6	280	435	56	14	581	94
Initial Q (Qb), veh	0	0	0	0	0	0	0	0	0	0	0	0
Ped-Bike Adj(A_pbT)	1.00		1.00	1.00		1.00	1.00		1.00	1.00		1.00
Parking Bus, Adj	1.00	1.00	1.00	1.00	1.00	1.00	1.00	1.00	1.00	1.00	1.00	1.00
Work Zone On Approach		No			No			No			No	
Adj Sat Flow, veh/h/ln	1870	1870	1870	1870	1870	1870	1870	1870	1870	1870	1870	1870
Adj Flow Rate, veh/h	145	312	0	37	114	0	318	494	0	18	632	0
Peak Hour Factor	0.83	0.88	0.92	0.78	0.80	0.78	0.88	0.88	0.78	0.78	0.92	0.80
Percent Heavy Veh, %	2	2	2	2	2	2	2	2	2	2	2	2
Cap, veh/h	297	635		213	426		378	1007		54	1631	
Arrive On Green	0.03	0.04	0.00	0.05	0.08	0.00	0.11	0.54	0.00	0.03	0.46	0.00
Sat Flow, veh/h	1781	5106	1585	1781	5106	1585	3456	1870	1585	1781	3554	1585
Grp Volume(v), veh/h	145	312	0	37	114	0	318	494	0	18	632	0
Grp Sat Flow(s),veh/h/ln	1781	1702	1585	1781	1702	1585	1728	1870	1585	1781	1777	1585
Q Serve(g_s), s	8.9	7.2	0.0	2.2	2.5	0.0	10.8	19.9	0.0	1.2	14.0	0.0
Cycle Q Clear(g_c), s	8.9	7.2	0.0	2.2	2.5	0.0	10.8	19.9	0.0	1.2	14.0	0.0
Prop In Lane	1.00		1.00	1.00		1.00	1.00		1.00	1.00		1.00
Lane Grp Cap(c), veh/h	297	635		213	426		378	1007		54	1631	
V/C Ratio(X)	0.49	0.49		0.17	0.27		0.84	0.49		0.34	0.39	
Avail Cap(c_a), veh/h	297	1302		286	1302		484	1007		249	1631	
HCM Platoon Ratio	0.33	0.33	0.33	1.00	1.00	1.00	1.00	1.00	1.00	1.00	1.00	1.00
Upstream Filter(I)	1.00	1.00	0.00	1.00	1.00	0.00	1.00	1.00	0.00	1.00	1.00	0.00
Uniform Delay (d), s/veh	47.8	53.8	0.0	46.3	51.6	0.0	52.4	17.4	0.0	57.0	21.4	0.0
Incr Delay (d2), s/veh	0.5	0.2	0.0	0.1	0.1	0.0	8.4	1.7	0.0	1.4	0.7	0.0
Initial Q Delay(d3),s/veh	0.0	0.0	0.0	0.0	0.0	0.0	0.0	0.0	0.0	0.0	0.0	0.0
%ile BackOfQ(50%),veh/ln	4.1	3.1	0.0	1.0	1.1	0.0	5.0	8.3	0.0	0.5	5.6	0.0
Unsig. Movement Delay, s/veh												
LnGrp Delay(d),s/veh	48.2	54.0	0.0	46.5	51.7	0.0	60.8	19.1	0.0	58.4	22.1	0.0
LnGrp LOS	D	D		D	D		E	B		E	C	
Approach Vol, veh/h		457			151			812			650	
Approach Delay, s/veh		52.2			50.4			35.4			23.1	
Approach LOS		D			D			D			C	
Timer - Assigned Phs	1	2	3	4	5	6	7	8				
Phs Duration (G+Y+Rc), s	11.8	72.8	13.1	22.3	21.3	63.3	18.0	17.4				
Change Period (Y+Rc), s	8.2	8.2	7.4	7.4	8.2	8.2	7.4	7.4				
Max Green Setting (Gmax), s	16.8	30.8	10.6	30.6	16.8	30.8	10.6	30.6				
Max Q Clear Time (g_c+I1), s	3.2	21.9	4.2	9.2	12.8	16.0	10.9	4.5				
Green Ext Time (p_c), s	0.0	2.5	0.0	0.7	0.3	4.5	0.0	0.2				

Intersection Summary												
HCM 6th Ctrl Delay											36.3	
HCM 6th LOS											D	

Notes

Unsignalized Delay for [NBR, EBR, WBR, SBR] is excluded from calculations of the approach delay and intersection delay.

Lanes, Volumes, Timings
4: Tower Road & Private Access



Lane Group	EBL	EBR	NBL	NBT	SBT	SBR
Lane Configurations						
Traffic Volume (vph)	0	20	0	701	1115	58
Future Volume (vph)	0	20	0	701	1115	58
Ideal Flow (vphpl)	1900	1900	1900	1900	1900	1900
Lane Util. Factor	1.00	1.00	1.00	0.95	0.91	0.91
Fr _t		0.865			0.991	
Fl _t Protected						
Satd. Flow (prot)	0	1611	0	3539	5040	0
Fl _t Permitted						
Satd. Flow (perm)	0	1611	0	3539	5040	0
Link Speed (mph)	30			30	30	
Link Distance (ft)	681			240	380	
Travel Time (s)	15.5			5.5	8.6	
Peak Hour Factor	0.78	0.78	0.78	0.92	0.93	0.78
Adj. Flow (vph)	0	26	0	762	1199	74
Shared Lane Traffic (%)						
Lane Group Flow (vph)	0	26	0	762	1273	0
Enter Blocked Intersection	No	No	No	No	No	No
Lane Alignment	Left	Right	Left	Left	Left	Right
Median Width(ft)	0			24	24	
Link Offset(ft)	0			0	0	
Crosswalk Width(ft)	16			16	16	
Two way Left Turn Lane						
Headway Factor	1.00	1.00	1.00	1.00	1.00	1.00
Turning Speed (mph)	15	9	15			9
Sign Control	Stop			Free	Free	

Intersection Summary

Area Type:	Other
Control Type:	Unsignalized
Intersection Capacity Utilization	32.8%
ICU Level of Service	A
Analysis Period (min)	15

Intersection						
Int Delay, s/veh	0.2					
Movement	EBL	EBR	NBL	NBT	SBT	SBR
Lane Configurations		↗		↑↑	↑↑↑	
Traffic Vol, veh/h	0	20	0	701	1115	58
Future Vol, veh/h	0	20	0	701	1115	58
Conflicting Peds, #/hr	0	0	0	0	0	0
Sign Control	Stop	Stop	Free	Free	Free	Free
RT Channelized	-	None	-	None	-	None
Storage Length	-	0	-	-	-	-
Veh in Median Storage, #	0	-	-	0	0	-
Grade, %	0	-	-	0	0	-
Peak Hour Factor	78	78	78	92	93	78
Heavy Vehicles, %	2	2	2	2	2	2
Mvmt Flow	0	26	0	762	1199	74

Major/Minor	Minor2	Major1	Major2		
Conflicting Flow All	-	637	-	0	-
Stage 1	-	-	-	-	-
Stage 2	-	-	-	-	-
Critical Hdwy	-	7.14	-	-	-
Critical Hdwy Stg 1	-	-	-	-	-
Critical Hdwy Stg 2	-	-	-	-	-
Follow-up Hdwy	-	3.92	-	-	-
Pot Cap-1 Maneuver	0	360	0	-	-
Stage 1	0	-	0	-	-
Stage 2	0	-	0	-	-
Platoon blocked, %				-	-
Mov Cap-1 Maneuver	-	360	-	-	-
Mov Cap-2 Maneuver	-	-	-	-	-
Stage 1	-	-	-	-	-
Stage 2	-	-	-	-	-

Approach	EB	NB	SB
HCM Control Delay, s	15.8	0	0
HCM LOS	C		

Minor Lane/Major Mvmt	NBT	EBLn1	SBT	SBR
Capacity (veh/h)	-	360	-	-
HCM Lane V/C Ratio	-	0.071	-	-
HCM Control Delay (s)	-	15.8	-	-
HCM Lane LOS	-	C	-	-
HCM 95th %tile Q(veh)	-	0.2	-	-

Lanes, Volumes, Timings
5: Tower Road & 103rd Avenue



Lane Group	EBL	EBR	NBL	NBT	SBT	SBR
Lane Configurations						
Traffic Volume (vph)	1	33	55	700	1101	14
Future Volume (vph)	1	33	55	700	1101	14
Ideal Flow (vphpl)	1900	1900	1900	1900	1900	1900
Storage Length (ft)	0	0	50			0
Storage Lanes	1	1	1			0
Taper Length (ft)	25		25			
Lane Util. Factor	1.00	1.00	1.00	0.95	0.91	0.91
Frt		0.850			0.998	
Flt Protected	0.950		0.950			
Satd. Flow (prot)	1770	1583	1770	3539	5075	0
Flt Permitted	0.950		0.950			
Satd. Flow (perm)	1770	1583	1770	3539	5075	0
Link Speed (mph)	30			30	30	
Link Distance (ft)	840			200	240	
Travel Time (s)	19.1			4.5	5.5	
Peak Hour Factor	0.78	0.78	0.78	0.92	0.93	0.78
Adj. Flow (vph)	1	42	71	761	1184	18
Shared Lane Traffic (%)						
Lane Group Flow (vph)	1	42	71	761	1202	0
Enter Blocked Intersection	No	No	No	No	No	No
Lane Alignment	Left	Right	Left	Left	Left	Right
Median Width(ft)	12			12	12	
Link Offset(ft)	0			0	0	
Crosswalk Width(ft)	16			16	16	
Two way Left Turn Lane						
Headway Factor	1.00	1.00	1.00	1.00	1.00	1.00
Turning Speed (mph)	15	9	15			9
Sign Control	Stop			Free	Free	

Intersection Summary

Area Type:	Other
Control Type:	Unsignalized
Intersection Capacity Utilization	38.3%
ICU Level of Service	A
Analysis Period (min)	15

























Intersection						
Int Delay, s/veh	1					
Movement	EBL	EBR	NBL	NBT	SBT	SBR
Lane Configurations	↵	↶	↵	↑↑	↑↑↑	
Traffic Vol, veh/h	1	33	55	700	1101	14
Future Vol, veh/h	1	33	55	700	1101	14
Conflicting Peds, #/hr	0	0	0	0	0	0
Sign Control	Stop	Stop	Free	Free	Free	Free
RT Channelized	-	None	-	None	-	None
Storage Length	0	0	50	-	-	-
Veh in Median Storage, #	0	-	-	0	0	-
Grade, %	0	-	-	0	0	-
Peak Hour Factor	78	78	78	92	93	78
Heavy Vehicles, %	2	2	2	2	2	2
Mvmt Flow	1	42	71	761	1184	18

Major/Minor	Minor2	Major1	Major2			
Conflicting Flow All	1716	601	1202	0	-	0
Stage 1	1193	-	-	-	-	-
Stage 2	523	-	-	-	-	-
Critical Hdwy	6.29	7.14	5.34	-	-	-
Critical Hdwy Stg 1	6.64	-	-	-	-	-
Critical Hdwy Stg 2	5.84	-	-	-	-	-
Follow-up Hdwy	3.67	3.92	3.12	-	-	-
Pot Cap-1 Maneuver	104	380	312	-	-	-
Stage 1	188	-	-	-	-	-
Stage 2	542	-	-	-	-	-
Platoon blocked, %				-	-	-
Mov Cap-1 Maneuver	80	380	312	-	-	-
Mov Cap-2 Maneuver	80	-	-	-	-	-
Stage 1	145	-	-	-	-	-
Stage 2	542	-	-	-	-	-

Approach	EB	NB	SB
HCM Control Delay, s	16.7	1.7	0
HCM LOS	C		

Minor Lane/Major Mvmt	NBL	NBT	EBLn1	EBLn2	SBT	SBR
Capacity (veh/h)	312	-	80	380	-	-
HCM Lane V/C Ratio	0.226	-	0.016	0.111	-	-
HCM Control Delay (s)	19.9	-	50.7	15.7	-	-
HCM Lane LOS	C	-	F	C	-	-
HCM 95th %tile Q(veh)	0.9	-	0	0.4	-	-

Lanes, Volumes, Timings
1: Walden Street & 104th Avenue

												
Lane Group	EBL	EBT	EBR	WBL	WBT	WBR	NBL	NBT	NBR	SBL	SBT	SBR
Lane Configurations												
Traffic Volume (vph)	24	497	125	20	689	87	170	38	36	55	14	19
Future Volume (vph)	24	497	125	20	689	87	170	38	36	55	14	19
Ideal Flow (vphpl)	1900	1900	1900	1900	1900	1900	1900	1900	1900	1900	1900	1900
Storage Length (ft)	400		250	250		0	220		220	210		130
Storage Lanes	1		1	1		1	1		1	1		1
Taper Length (ft)	25			25			25			25		
Lane Util. Factor	1.00	0.95	1.00	1.00	0.95	1.00	1.00	1.00	1.00	1.00	1.00	1.00
Frt			0.850			0.850			0.850			0.850
Flt Protected	0.950			0.950			0.950			0.950		
Satd. Flow (prot)	1770	3539	1583	1770	3539	1583	1770	1863	1583	1770	1863	1583
Flt Permitted	0.322			0.417			0.358			0.725		
Satd. Flow (perm)	600	3539	1583	777	3539	1583	667	1863	1583	1350	1863	1583
Right Turn on Red			Yes			Yes			Yes			Yes
Satd. Flow (RTOR)			218			218			227			168
Link Speed (mph)		45			45			30				30
Link Distance (ft)		1000			641			380				215
Travel Time (s)		15.2			9.7			8.6				4.9
Peak Hour Factor	0.78	0.88	0.84	0.78	0.92	0.78	0.84	0.78	0.78	0.78	0.78	0.78
Adj. Flow (vph)	31	565	149	26	749	112	202	49	46	71	18	24
Shared Lane Traffic (%)												
Lane Group Flow (vph)	31	565	149	26	749	112	202	49	46	71	18	24
Enter Blocked Intersection	No	No	No	No	No	No	No	No	No	No	No	No
Lane Alignment	Left	Left	Right	Left	Left	Right	Left	Left	Right	Left	Left	Right
Median Width(ft)		12			12			12				12
Link Offset(ft)		0			0			0				0
Crosswalk Width(ft)		16			16			16				16
Two way Left Turn Lane												
Headway Factor	1.00	1.00	1.00	1.00	1.00	1.00	1.00	1.00	1.00	1.00	1.00	1.00
Turning Speed (mph)	15		9	15		9	15		9	15		9
Number of Detectors	1	1	1	1	1	1	1	1	1	1	1	1
Detector Template	Left	Thru	Right	Left	Thru	Right	Left	Thru	Right	Left	Thru	Right
Leading Detector (ft)	20	100	20	20	100	20	20	100	20	20	100	20
Trailing Detector (ft)	0	0	0	0	0	0	0	0	0	0	0	0
Detector 1 Position(ft)	0	0	0	0	0	0	0	0	0	0	0	0
Detector 1 Size(ft)	20	100	20	20	100	20	20	100	20	20	100	20
Detector 1 Type	Cl+Ex	Cl+Ex	Cl+Ex	Cl+Ex	Cl+Ex	Cl+Ex	Cl+Ex	Cl+Ex	Cl+Ex	Cl+Ex	Cl+Ex	Cl+Ex
Detector 1 Channel												
Detector 1 Extend (s)	0.0	0.0	0.0	0.0	0.0	0.0	0.0	0.0	0.0	0.0	0.0	0.0
Detector 1 Queue (s)	0.0	0.0	0.0	0.0	0.0	0.0	0.0	0.0	0.0	0.0	0.0	0.0
Detector 1 Delay (s)	0.0	0.0	0.0	0.0	0.0	0.0	0.0	0.0	0.0	0.0	0.0	0.0
Turn Type	pm+pt	NA	Perm	pm+pt	NA	Perm	pm+pt	NA	Perm	pm+pt	NA	Perm
Protected Phases	5	2		1	6		3	8		7	4	
Permitted Phases	2		2	6		6	8		8	4		4
Detector Phase	5	2	2	1	6	6	3	8	8	7	4	4
Switch Phase												
Minimum Initial (s)	5.0	10.0	10.0	5.0	10.0	10.0	8.0	10.0	10.0	8.0	10.0	10.0
Minimum Split (s)	12.5	17.5	17.5	12.5	17.5	17.5	14.5	16.5	16.5	14.5	16.5	16.5
Total Split (s)	18.0	57.0	57.0	13.0	52.0	52.0	25.0	17.0	17.0	33.0	25.0	25.0

Lanes, Volumes, Timings
1: Walden Street & 104th Avenue



Lane Group	EBL	EBT	EBR	WBL	WBT	WBR	NBL	NBT	NBR	SBL	SBT	SBR
Total Split (%)	15.0%	47.5%	47.5%	10.8%	43.3%	43.3%	20.8%	14.2%	14.2%	27.5%	20.8%	20.8%
Maximum Green (s)	10.5	49.5	49.5	5.5	44.5	44.5	18.5	10.5	10.5	26.5	18.5	18.5
Yellow Time (s)	5.3	5.3	5.3	5.3	5.3	5.3	3.8	3.8	3.8	3.8	3.8	3.8
All-Red Time (s)	2.2	2.2	2.2	2.2	2.2	2.2	2.7	2.7	2.7	2.7	2.7	2.7
Lost Time Adjust (s)	0.0	0.0	0.0	0.0	0.0	0.0	0.0	0.0	0.0	0.0	0.0	0.0
Total Lost Time (s)	7.5	7.5	7.5	7.5	7.5	7.5	6.5	6.5	6.5	6.5	6.5	6.5
Lead/Lag	Lead	Lag	Lag	Lead	Lag	Lag	Lead	Lag	Lag	Lead	Lag	Lag
Lead-Lag Optimize?	Yes	Yes	Yes	Yes	Yes	Yes	Yes	Yes	Yes	Yes	Yes	Yes
Vehicle Extension (s)	2.0	5.0	5.0	2.0	5.0	5.0	2.0	2.0	2.0	2.0	2.0	2.0
Recall Mode	None	C-Max	C-Max	None	C-Max	C-Max	None	None	None	None	None	None
Act Effct Green (s)	74.1	70.5	70.5	73.8	70.4	70.4	27.6	15.1	15.1	14.9	10.0	10.0
Actuated g/C Ratio	0.62	0.59	0.59	0.62	0.59	0.59	0.23	0.13	0.13	0.12	0.08	0.08
v/c Ratio	0.07	0.27	0.15	0.05	0.36	0.11	0.64	0.21	0.12	0.36	0.12	0.08
Control Delay	10.2	15.2	0.7	5.3	8.1	0.4	48.0	48.0	0.6	41.7	52.9	0.6
Queue Delay	0.0	0.0	0.0	0.0	0.0	0.0	0.0	0.0	0.0	0.0	0.0	0.0
Total Delay	10.2	15.2	0.7	5.3	8.1	0.4	48.0	48.0	0.6	41.7	52.9	0.6
LOS	B	B	A	A	A	A	D	D	A	D	D	A
Approach Delay		12.1			7.0			40.7			34.8	
Approach LOS		B			A			D			C	

Intersection Summary

Area Type: Other
 Cycle Length: 120
 Actuated Cycle Length: 120
 Offset: 0.7 (1%), Referenced to phase 2:EBTL and 6:WBTL, Start of Yellow
 Natural Cycle: 65
 Control Type: Actuated-Coordinated
 Maximum v/c Ratio: 0.64
 Intersection Signal Delay: 15.3
 Intersection LOS: B
 Intersection Capacity Utilization 53.9%
 ICU Level of Service A
 Analysis Period (min) 15

Splits and Phases: 1: Walden Street & 104th Avenue



Queues
1: Walden Street & 104th Avenue

JR Engineering
09/20/2023



























Lane Group	EBL	EBT	EBR	WBL	WBT	WBR	NBL	NBT	NBR	SBL	SBT	SBR
Lane Group Flow (vph)	31	565	149	26	749	112	202	49	46	71	18	24
v/c Ratio	0.07	0.27	0.15	0.05	0.36	0.11	0.64	0.21	0.12	0.36	0.12	0.08
Control Delay	10.2	15.2	0.7	5.3	8.1	0.4	48.0	48.0	0.6	41.7	52.9	0.6
Queue Delay	0.0	0.0	0.0	0.0	0.0	0.0	0.0	0.0	0.0	0.0	0.0	0.0
Total Delay	10.2	15.2	0.7	5.3	8.1	0.4	48.0	48.0	0.6	41.7	52.9	0.6
Queue Length 50th (ft)	9	130	0	4	125	0	129	34	0	42	13	0
Queue Length 95th (ft)	20	176	0	m7	158	m0	180	61	0	68	33	0
Internal Link Dist (ft)		920			561			300			135	
Turn Bay Length (ft)	400		250	250			220		220	210		130
Base Capacity (vph)	486	2080	1020	525	2076	1018	342	235	398	441	287	386
Starvation Cap Reductn	0	0	0	0	0	0	0	0	0	0	0	0
Spillback Cap Reductn	0	0	0	0	0	0	0	0	0	0	0	0
Storage Cap Reductn	0	0	0	0	0	0	0	0	0	0	0	0
Reduced v/c Ratio	0.06	0.27	0.15	0.05	0.36	0.11	0.59	0.21	0.12	0.16	0.06	0.06

Intersection Summary

m Volume for 95th percentile queue is metered by upstream signal.

HCM 6th Signalized Intersection Summary
 1: Walden Street & 104th Avenue

JR Engineering
 09/20/2023

												
Movement	EBL	EBT	EBR	WBL	WBT	WBR	NBL	NBT	NBR	SBL	SBT	SBR
Lane Configurations												
Traffic Volume (veh/h)	24	497	125	20	689	87	170	38	36	55	14	19
Future Volume (veh/h)	24	497	125	20	689	87	170	38	36	55	14	19
Initial Q (Qb), veh	0	0	0	0	0	0	0	0	0	0	0	0
Ped-Bike Adj(A_pbT)	1.00		1.00	1.00		1.00	1.00		1.00	1.00		1.00
Parking Bus, Adj	1.00	1.00	1.00	1.00	1.00	1.00	1.00	1.00	1.00	1.00	1.00	1.00
Work Zone On Approach		No			No			No			No	
Adj Sat Flow, veh/h/ln	1870	1870	1870	1870	1870	1870	1870	1870	1870	1870	1870	1870
Adj Flow Rate, veh/h	31	565	149	26	749	112	202	49	46	71	18	24
Peak Hour Factor	0.78	0.88	0.84	0.78	0.92	0.78	0.84	0.78	0.78	0.78	0.78	0.78
Percent Heavy Veh, %	2	2	2	2	2	2	2	2	2	2	2	2
Cap, veh/h	353	1925	859	438	1915	854	371	263	223	276	156	132
Arrive On Green	0.03	0.54	0.54	0.02	0.36	0.36	0.12	0.14	0.14	0.06	0.08	0.08
Sat Flow, veh/h	1781	3554	1585	1781	3554	1585	1781	1870	1585	1781	1870	1585
Grp Volume(v), veh/h	31	565	149	26	749	112	202	49	46	71	18	24
Grp Sat Flow(s),veh/h/ln	1781	1777	1585	1781	1777	1585	1781	1870	1585	1781	1870	1585
Q Serve(g_s), s	0.9	10.4	5.7	0.8	18.8	5.7	12.0	2.8	3.1	4.3	1.1	1.7
Cycle Q Clear(g_c), s	0.9	10.4	5.7	0.8	18.8	5.7	12.0	2.8	3.1	4.3	1.1	1.7
Prop In Lane	1.00		1.00	1.00		1.00	1.00		1.00	1.00		1.00
Lane Grp Cap(c), veh/h	353	1925	859	438	1915	854	371	263	223	276	156	132
V/C Ratio(X)	0.09	0.29	0.17	0.06	0.39	0.13	0.54	0.19	0.21	0.26	0.12	0.18
Avail Cap(c_a), veh/h	461	1925	859	477	1915	854	436	263	223	562	288	244
HCM Platoon Ratio	1.00	1.00	1.00	0.67	0.67	0.67	1.00	1.00	1.00	1.00	1.00	1.00
Upstream Filter(I)	1.00	1.00	1.00	1.00	1.00	1.00	1.00	1.00	1.00	1.00	1.00	1.00
Uniform Delay (d), s/veh	13.1	15.0	13.9	12.2	23.7	19.5	41.5	45.5	45.7	45.8	50.9	51.2
Incr Delay (d2), s/veh	0.0	0.4	0.4	0.0	0.6	0.3	0.5	0.1	0.2	0.2	0.1	0.2
Initial Q Delay(d3),s/veh	0.0	0.0	0.0	0.0	0.0	0.0	0.0	0.0	0.0	0.0	0.0	0.0
%ile BackOfQ(50%),veh/ln	0.3	4.0	2.1	0.3	8.4	2.2	5.3	1.3	1.2	1.9	0.5	0.7
Unsig. Movement Delay, s/veh												
LnGrp Delay(d),s/veh	13.1	15.4	14.4	12.2	24.3	19.8	41.9	45.6	45.8	46.0	51.0	51.4
LnGrp LOS	B	B	B	B	C	B	D	D	D	D	D	D
Approach Vol, veh/h		745			887			297			113	
Approach Delay, s/veh		15.1			23.4			43.2			48.0	
Approach LOS		B			C			D			D	
Timer - Assigned Phs	1	2	3	4	5	6	7	8				
Phs Duration (G+Y+Rc), s	10.4	72.5	20.6	16.5	10.7	72.2	13.7	23.4				
Change Period (Y+Rc), s	* 7.5	* 7.5	6.5	6.5	* 7.5	* 7.5	6.5	6.5				
Max Green Setting (Gmax), s	* 5.5	* 50	18.5	18.5	* 11	* 45	26.5	10.5				
Max Q Clear Time (g_c+I1), s	2.8	12.4	14.0	3.7	2.9	20.8	6.3	5.1				
Green Ext Time (p_c), s	0.0	9.0	0.1	0.0	0.0	9.8	0.1	0.1				

Intersection Summary

HCM 6th Ctrl Delay	24.6
HCM 6th LOS	C

Notes

- User approved pedestrian interval to be less than phase max green.
- * HCM 6th computational engine requires equal clearance times for the phases crossing the barrier.

Lanes, Volumes, Timings
2: Yampa Street & 104th Avenue



Lane Group	EBT	EBR	WBL	WBT	NBL	NBR
Lane Configurations	↑↑↑	↑	↓	↑↑↑		↓
Traffic Volume (vph)	588	12	16	453	0	12
Future Volume (vph)	588	12	16	453	0	12
Ideal Flow (vphpl)	1900	1900	1900	1900	1900	1900
Storage Length (ft)		200	140		0	0
Storage Lanes		1	1		0	1
Taper Length (ft)			25		25	
Lane Util. Factor	0.91	1.00	1.00	0.91	1.00	1.00
Frt		0.850				0.865
Flt Protected			0.950			
Satd. Flow (prot)	5085	1583	1770	5085	0	1611
Flt Permitted			0.950			
Satd. Flow (perm)	5085	1583	1770	5085	0	1611
Link Speed (mph)	30			30	30	
Link Distance (ft)	641			1041	275	
Travel Time (s)	14.6			23.7	6.3	
Peak Hour Factor	0.92	0.78	0.78	0.88	0.78	0.78
Adj. Flow (vph)	639	15	21	515	0	15
Shared Lane Traffic (%)						
Lane Group Flow (vph)	639	15	21	515	0	15
Enter Blocked Intersection	No	No	No	No	No	No
Lane Alignment	Left	Right	Left	Left	Left	Right
Median Width(ft)	12			12	0	
Link Offset(ft)	0			0	0	
Crosswalk Width(ft)	16			16	16	
Two way Left Turn Lane						
Headway Factor	1.00	1.00	1.00	1.00	1.00	1.00
Turning Speed (mph)		60	60		60	60
Sign Control	Free			Free	Stop	

Intersection Summary

Area Type:	Other
Control Type:	Unsignalized
Intersection Capacity Utilization	21.4%
ICU Level of Service	A
Analysis Period (min)	15

Intersection						
Int Delay, s/veh	0.3					
Movement	EBT	EBR	WBL	WBT	NBL	NBR
Lane Configurations	↑↑↑	↑	↑	↑↑↑		↑
Traffic Vol, veh/h	588	12	16	453	0	12
Future Vol, veh/h	588	12	16	453	0	12
Conflicting Peds, #/hr	0	0	0	0	0	0
Sign Control	Free	Free	Free	Free	Stop	Stop
RT Channelized	-	None	-	None	-	None
Storage Length	-	200	140	-	-	0
Veh in Median Storage, #	0	-	-	0	0	-
Grade, %	0	-	-	0	0	-
Peak Hour Factor	92	78	78	88	78	78
Heavy Vehicles, %	2	2	2	2	2	2
Mvmt Flow	639	15	21	515	0	15

Major/Minor	Major1	Major2	Minor1	Minor2	Minor3
Conflicting Flow All	0	0	654	0	- 320
Stage 1	-	-	-	-	-
Stage 2	-	-	-	-	-
Critical Hdwy	-	-	5.34	-	- 7.14
Critical Hdwy Stg 1	-	-	-	-	-
Critical Hdwy Stg 2	-	-	-	-	-
Follow-up Hdwy	-	-	3.12	-	- 3.92
Pot Cap-1 Maneuver	-	-	573	-	0 577
Stage 1	-	-	-	-	0 -
Stage 2	-	-	-	-	0 -
Platoon blocked, %	-	-	-	-	-
Mov Cap-1 Maneuver	-	-	573	-	- 577
Mov Cap-2 Maneuver	-	-	-	-	-
Stage 1	-	-	-	-	-
Stage 2	-	-	-	-	-

Approach	EB	WB	NB
HCM Control Delay, s	0	0.4	11.4
HCM LOS			B

Minor Lane/Major Mvmt	NBLn1	EBT	EBR	WBL	WBT
Capacity (veh/h)	577	-	-	573	-
HCM Lane V/C Ratio	0.027	-	-	0.036	-
HCM Control Delay (s)	11.4	-	-	11.5	-
HCM Lane LOS	B	-	-	B	-
HCM 95th %tile Q(veh)	0.1	-	-	0.1	-

Lanes, Volumes, Timings
3: Tower Road & 104th Avenue

Lane Group	EBL	EBT	EBR	WBL	WBT	WBR	NBL	NBT	NBR	SBL	SBT	SBR
Lane Configurations												
Traffic Volume (vph)	97	132	371	21	177	16	560	750	26	9	439	75
Future Volume (vph)	97	132	371	21	177	16	560	750	26	9	439	75
Ideal Flow (vphpl)	1900	1900	1900	1900	1900	1900	1900	1900	1900	1900	1900	1900
Storage Length (ft)	350		590	330		440	320		290	290		190
Storage Lanes	1		1	1		1	2		1	1		1
Taper Length (ft)	25			25			25			25		
Lane Util. Factor	1.00	0.91	1.00	1.00	0.91	1.00	0.97	1.00	1.00	1.00	0.95	1.00
Frt			0.850			0.850			0.850			0.850
Flt Protected	0.950			0.950			0.950			0.950		
Satd. Flow (prot)	1770	5085	1583	1770	5085	1583	3433	1863	1583	1770	3539	1583
Flt Permitted	0.491			0.648			0.950			0.950		
Satd. Flow (perm)	915	5085	1583	1207	5085	1583	3433	1863	1583	1770	3539	1583
Right Turn on Red			Yes			Yes			Yes			Yes
Satd. Flow (RTOR)			422			264			182			256
Link Speed (mph)		45			45			50			50	
Link Distance (ft)		1041			151			380			500	
Travel Time (s)		15.8			2.3			5.2			6.8	
Peak Hour Factor	0.78	0.84	0.88	0.78	0.84	0.78	0.92	0.92	0.78	0.78	0.88	0.78
Adj. Flow (vph)	124	157	422	27	211	21	609	815	33	12	499	96
Shared Lane Traffic (%)												
Lane Group Flow (vph)	124	157	422	27	211	21	609	815	33	12	499	96
Enter Blocked Intersection	No	No	No	No	No	No	No	No	No	No	No	No
Lane Alignment	Left	Left	Right	Left	Left	Right	Left	Left	Right	Left	Left	Right
Median Width(ft)		12			12			24			24	
Link Offset(ft)		0			0			0			0	
Crosswalk Width(ft)		16			16			16			16	
Two way Left Turn Lane												
Headway Factor	1.00	1.00	1.00	1.00	1.00	1.00	1.00	1.00	1.00	1.00	1.00	1.00
Turning Speed (mph)	15		9	15		9	15		9	15		9
Number of Detectors	1	1	1	1	1	1	1	1	1	1	1	1
Detector Template	Left	Thru	Right	Left	Thru	Right	Left	Thru	Right	Left	Thru	Right
Leading Detector (ft)	40	40	40	40	40	40	40	40	40	40	40	40
Trailing Detector (ft)	0	0	0	0	0	0	0	0	0	0	0	0
Detector 1 Position(ft)	0	0	0	0	0	0	0	0	0	0	0	0
Detector 1 Size(ft)	40	40	40	40	40	40	40	40	40	40	40	40
Detector 1 Type	Cl+Ex	Cl+Ex	Cl+Ex	Cl+Ex	Cl+Ex	Cl+Ex	Cl+Ex	Cl+Ex	Cl+Ex	Cl+Ex	Cl+Ex	Cl+Ex
Detector 1 Channel												
Detector 1 Extend (s)	0.0	0.0	0.0	0.0	0.0	0.0	0.0	0.0	0.0	0.0	0.0	0.0
Detector 1 Queue (s)	0.0	0.0	0.0	0.0	0.0	0.0	0.0	0.0	0.0	0.0	0.0	0.0
Detector 1 Delay (s)	0.0	0.0	0.0	0.0	0.0	0.0	0.0	0.0	0.0	0.0	0.0	0.0
Turn Type	pm+pt	NA	Perm	pm+pt	NA	Perm	Prot	NA	Perm	Prot	NA	Perm
Protected Phases	7	4		3	8		5	2		1	6	
Permitted Phases	4		4	8		8			2			6
Detector Phase	7	4	4	3	8	8	5	2	2	1	6	6
Switch Phase												
Minimum Initial (s)	8.0	10.0	10.0	8.0	10.0	10.0	8.0	10.0	10.0	8.0	10.0	10.0
Minimum Split (s)	15.4	39.4	39.4	15.4	39.4	39.4	16.2	40.2	40.2	16.2	40.2	40.2
Total Split (s)	16.0	32.0	32.0	16.0	32.0	32.0	30.0	55.0	55.0	17.0	42.0	42.0

Lanes, Volumes, Timings
3: Tower Road & 104th Avenue



Lane Group	EBL	EBT	EBR	WBL	WBT	WBR	NBL	NBT	NBR	SBL	SBT	SBR
Total Split (%)	13.3%	26.7%	26.7%	13.3%	26.7%	26.7%	25.0%	45.8%	45.8%	14.2%	35.0%	35.0%
Maximum Green (s)	8.6	24.6	24.6	8.6	24.6	24.6	21.8	46.8	46.8	8.8	33.8	33.8
Yellow Time (s)	5.0	5.0	5.0	5.0	5.0	5.0	5.1	5.1	5.1	5.1	5.1	5.1
All-Red Time (s)	2.4	2.4	2.4	2.4	2.4	2.4	3.1	3.1	3.1	3.1	3.1	3.1
Lost Time Adjust (s)	0.0	0.0	0.0	0.0	0.0	0.0	0.0	0.0	0.0	0.0	0.0	0.0
Total Lost Time (s)	7.4	7.4	7.4	7.4	7.4	7.4	8.2	8.2	8.2	8.2	8.2	8.2
Lead/Lag	Lead	Lag	Lag	Lead	Lag	Lag	Lead	Lag	Lag	Lead	Lag	Lag
Lead-Lag Optimize?	Yes	Yes	Yes	Yes	Yes	Yes	Yes	Yes	Yes	Yes	Yes	Yes
Vehicle Extension (s)	2.0	2.0	2.0	2.0	2.0	2.0	2.0	5.0	5.0	2.0	5.0	5.0
Recall Mode	None	None	None	None	None	None	None	C-Min	C-Min	None	C-Min	C-Min
Act Effct Green (s)	23.6	18.4	18.4	19.8	11.8	11.8	26.8	73.5	73.5	8.0	41.7	41.7
Actuated g/C Ratio	0.20	0.15	0.15	0.16	0.10	0.10	0.22	0.61	0.61	0.07	0.35	0.35
v/c Ratio	0.52	0.20	0.70	0.11	0.42	0.05	0.80	0.71	0.03	0.10	0.41	0.13
Control Delay	41.4	42.0	25.5	36.0	53.0	0.2	52.4	22.7	0.0	54.8	31.9	0.4
Queue Delay	0.0	0.0	0.0	0.0	0.0	0.0	0.0	0.0	0.0	0.0	0.0	0.0
Total Delay	41.4	42.0	25.5	36.0	53.0	0.2	52.4	22.7	0.0	54.8	31.9	0.4
LOS	D	D	C	D	D	A	D	C	A	D	C	A
Approach Delay		32.0			47.0			34.6			27.4	
Approach LOS		C			D			C			C	

Intersection Summary

Area Type: Other
 Cycle Length: 120
 Actuated Cycle Length: 120
 Offset: 0 (0%), Referenced to phase 2:NBT and 6:SBT, Start of Yellow, Master Intersection
 Natural Cycle: 135
 Control Type: Actuated-Coordinated
 Maximum v/c Ratio: 0.80
 Intersection Signal Delay: 33.6
 Intersection LOS: C
 Intersection Capacity Utilization 87.1%
 ICU Level of Service E
 Analysis Period (min) 15

Splits and Phases: 3: Tower Road & 104th Avenue

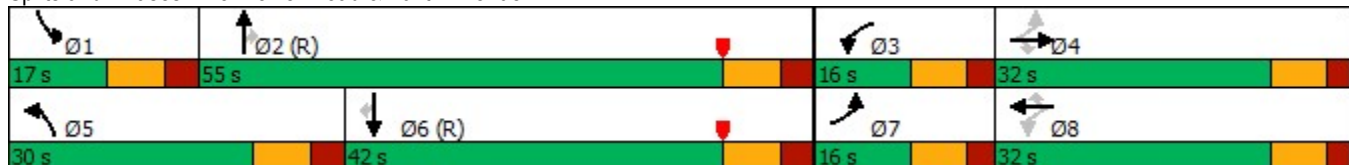

Queues
3: Tower Road & 104th Avenue



Lane Group	EBL	EBT	EBR	WBL	WBT	WBR	NBL	NBT	NBR	SBL	SBT	SBR
Lane Group Flow (vph)	124	157	422	27	211	21	609	815	33	12	499	96
v/c Ratio	0.52	0.20	0.70	0.11	0.42	0.05	0.80	0.71	0.03	0.10	0.41	0.13
Control Delay	41.4	42.0	25.5	36.0	53.0	0.2	52.4	22.7	0.0	54.8	31.9	0.4
Queue Delay	0.0	0.0	0.0	0.0	0.0	0.0	0.0	0.0	0.0	0.0	0.0	0.0
Total Delay	41.4	42.0	25.5	36.0	53.0	0.2	52.4	22.7	0.0	54.8	31.9	0.4
Queue Length 50th (ft)	86	43	147	17	58	0	228	359	0	9	151	0
Queue Length 95th (ft)	117	60	227	33	73	0	295	#885	0	26	218	0
Internal Link Dist (ft)		961			71			300				420
Turn Bay Length (ft)	350		590	330		440	320		290	290		190
Base Capacity (vph)	240	1061	664	245	1042	534	766	1141	1040	129	1230	717
Starvation Cap Reductn	0	0	0	0	0	0	0	0	0	0	0	0
Spillback Cap Reductn	0	0	0	0	0	0	0	0	0	0	0	0
Storage Cap Reductn	0	0	0	0	0	0	0	0	0	0	0	0
Reduced v/c Ratio	0.52	0.15	0.64	0.11	0.20	0.04	0.80	0.71	0.03	0.09	0.41	0.13

Intersection Summary

95th percentile volume exceeds capacity, queue may be longer.
Queue shown is maximum after two cycles.

HCM 6th Signalized Intersection Summary
3: Tower Road & 104th Avenue

JR Engineering
09/20/2023



Movement	EBL	EBT	EBR	WBL	WBT	WBR	NBL	NBT	NBR	SBL	SBT	SBR
Lane Configurations	↘	↑↑↑	↘	↘	↑↑↑	↘	↘↘	↑	↘	↘	↑↑	↘
Traffic Volume (veh/h)	97	132	371	21	177	16	560	750	26	9	439	75
Future Volume (veh/h)	97	132	371	21	177	16	560	750	26	9	439	75
Initial Q (Qb), veh	0	0	0	0	0	0	0	0	0	0	0	0
Ped-Bike Adj(A_pbT)	1.00		1.00	1.00		1.00	1.00		1.00	1.00		1.00
Parking Bus, Adj	1.00	1.00	1.00	1.00	1.00	1.00	1.00	1.00	1.00	1.00	1.00	1.00
Work Zone On Approach		No			No			No			No	
Adj Sat Flow, veh/h/ln	1870	1870	1870	1870	1870	1870	1870	1870	1870	1870	1870	1870
Adj Flow Rate, veh/h	124	157	0	27	211	0	609	815	0	12	499	0
Peak Hour Factor	0.78	0.84	0.88	0.78	0.84	0.78	0.92	0.92	0.78	0.78	0.88	0.78
Percent Heavy Veh, %	2	2	2	2	2	2	2	2	2	2	2	2
Cap, veh/h	239	589		233	426		628	1053		39	1433	
Arrive On Green	0.07	0.12	0.00	0.04	0.08	0.00	0.18	0.56	0.00	0.02	0.40	0.00
Sat Flow, veh/h	1781	5106	1585	1781	5106	1585	3456	1870	1585	1781	3554	1585
Grp Volume(v), veh/h	124	157	0	27	211	0	609	815	0	12	499	0
Grp Sat Flow(s),veh/h/ln	1781	1702	1585	1781	1702	1585	1728	1870	1585	1781	1777	1585
Q Serve(g_s), s	7.6	3.4	0.0	1.6	4.7	0.0	21.0	40.5	0.0	0.8	11.7	0.0
Cycle Q Clear(g_c), s	7.6	3.4	0.0	1.6	4.7	0.0	21.0	40.5	0.0	0.8	11.7	0.0
Prop In Lane	1.00		1.00	1.00		1.00	1.00		1.00	1.00		1.00
Lane Grp Cap(c), veh/h	239	589		233	426		628	1053		39	1433	
V/C Ratio(X)	0.52	0.27		0.12	0.50		0.97	0.77		0.31	0.35	
Avail Cap(c_a), veh/h	239	1047		290	1047		628	1053		131	1433	
HCM Platoon Ratio	1.00	1.00	1.00	1.00	1.00	1.00	1.00	1.00	1.00	1.00	1.00	1.00
Upstream Filter(I)	1.00	1.00	0.00	1.00	1.00	0.00	1.00	1.00	0.00	1.00	1.00	0.00
Uniform Delay (d), s/veh	46.2	48.4	0.0	46.9	52.6	0.0	48.8	20.3	0.0	57.8	24.9	0.0
Incr Delay (d2), s/veh	0.9	0.1	0.0	0.1	0.3	0.0	28.3	5.5	0.0	1.6	0.7	0.0
Initial Q Delay(d3),s/veh	0.0	0.0	0.0	0.0	0.0	0.0	0.0	0.0	0.0	0.0	0.0	0.0
%ile BackOfQ(50%),veh/ln	3.3	1.4	0.0	0.7	2.0	0.0	11.1	17.2	0.0	0.4	4.8	0.0
Unsig. Movement Delay, s/veh												
LnGrp Delay(d),s/veh	47.1	48.5	0.0	47.0	52.9	0.0	77.1	25.9	0.0	59.4	25.5	0.0
LnGrp LOS	D	D		D	D		E	C		E	C	
Approach Vol, veh/h		281			238			1424			511	
Approach Delay, s/veh		47.9			52.2			47.8			26.3	
Approach LOS		D			D			D			C	
Timer - Assigned Phs	1	2	3	4	5	6	7	8				
Phs Duration (G+Y+Rc), s	10.8	75.8	12.1	21.3	30.0	56.6	16.0	17.4				
Change Period (Y+Rc), s	8.2	8.2	7.4	7.4	8.2	8.2	7.4	7.4				
Max Green Setting (Gmax), s	8.8	46.8	8.6	24.6	21.8	33.8	8.6	24.6				
Max Q Clear Time (g_c+I1), s	2.8	42.5	3.6	5.4	23.0	13.7	9.6	6.7				
Green Ext Time (p_c), s	0.0	2.5	0.0	0.3	0.0	4.0	0.0	0.4				

Intersection Summary

HCM 6th Ctrl Delay	43.7
HCM 6th LOS	D

Notes

Unsignalized Delay for [NBR, EBR, WBR, SBR] is excluded from calculations of the approach delay and intersection delay.

Lanes, Volumes, Timings
4: Tower Road & Private Access



Lane Group	EBL	EBR	NBL	NBT	SBT	SBR
Lane Configurations						
Traffic Volume (vph)	0	0	0	0	0	0
Future Volume (vph)	0	0	0	0	0	0
Ideal Flow (vphpl)	1900	1900	1900	1900	1900	1900
Lane Util. Factor	1.00	1.00	1.00	0.95	0.91	0.91
Frt						
Flt Protected						
Satd. Flow (prot)	0	1863	0	3539	5085	0
Flt Permitted						
Satd. Flow (perm)	0	1863	0	3539	5085	0
Link Speed (mph)	30			30	30	
Link Distance (ft)	681			240	380	
Travel Time (s)	15.5			5.5	8.6	
Peak Hour Factor	0.78	0.78	0.78	0.78	0.78	0.78
Adj. Flow (vph)	0	0	0	0	0	0
Shared Lane Traffic (%)						
Lane Group Flow (vph)	0	0	0	0	0	0
Enter Blocked Intersection	No	No	No	No	No	No
Lane Alignment	Left	Right	Left	Left	Left	Right
Median Width(ft)	0			24	24	
Link Offset(ft)	0			0	0	
Crosswalk Width(ft)	16			16	16	
Two way Left Turn Lane						
Headway Factor	1.00	1.00	1.00	1.00	1.00	1.00
Turning Speed (mph)	60	60	60			60
Sign Control	Stop			Free	Free	
Intersection Summary						
Area Type:	Other					
Control Type:	Unsignalized					
Intersection Capacity Utilization	0.0%			ICU Level of Service A		
Analysis Period (min)	15					

Intersection						
Int Delay, s/veh	0					
Movement	EBL	EBR	NBL	NBT	SBT	SBR
Lane Configurations		↗		↑↑	↑↑↑	
Traffic Vol, veh/h	0	0	0	0	0	0
Future Vol, veh/h	0	0	0	0	0	0
Conflicting Peds, #/hr	0	0	0	0	0	0
Sign Control	Stop	Stop	Free	Free	Free	Free
RT Channelized	-	None	-	None	-	None
Storage Length	-	0	-	-	-	-
Veh in Median Storage, #	0	-	-	0	0	-
Grade, %	0	-	-	0	0	-
Peak Hour Factor	78	78	78	78	78	78
Heavy Vehicles, %	2	2	2	2	2	2
Mvmt Flow	0	0	0	0	0	0

Major/Minor	Minor2	Major1	Major2
Conflicting Flow All	-	1	0
Stage 1	-	-	-
Stage 2	-	-	-
Critical Hdwy	-	7.14	-
Critical Hdwy Stg 1	-	-	-
Critical Hdwy Stg 2	-	-	-
Follow-up Hdwy	-	3.92	-
Pot Cap-1 Maneuver	0	917	0
Stage 1	0	-	0
Stage 2	0	-	0
Platoon blocked, %			
Mov Cap-1 Maneuver	-	917	-
Mov Cap-2 Maneuver	-	-	-
Stage 1	-	-	-
Stage 2	-	-	-

Approach	EB	NB	SB
HCM Control Delay, s	0	0	0
HCM LOS	A		

Minor Lane/Major Mvmt	NBT	EBLn1	SBT	SBR
Capacity (veh/h)	-	-	-	-
HCM Lane V/C Ratio	-	-	-	-
HCM Control Delay (s)	-	0	-	-
HCM Lane LOS	-	A	-	-
HCM 95th %tile Q(veh)	-	-	-	-

Lanes, Volumes, Timings
5: Tower Road & 103rd Avenue



Lane Group	EBL	EBR	NBL	NBT	SBT	SBR
Lane Configurations						
Traffic Volume (vph)	7	33	108	1238	876	8
Future Volume (vph)	7	33	108	1238	876	8
Ideal Flow (vphpl)	1900	1900	1900	1900	1900	1900
Storage Length (ft)	0	0	50			0
Storage Lanes	1	1	1			0
Taper Length (ft)	25		25			
Lane Util. Factor	1.00	1.00	1.00	0.95	0.91	0.91
Frt		0.850			0.998	
Flt Protected	0.950		0.950			
Satd. Flow (prot)	1770	1583	1770	3539	5075	0
Flt Permitted	0.950		0.950			
Satd. Flow (perm)	1770	1583	1770	3539	5075	0
Link Speed (mph)	30			30	30	
Link Distance (ft)	840			200	240	
Travel Time (s)	19.1			4.5	5.5	
Peak Hour Factor	0.78	0.78	0.83	0.93	0.92	0.78
Adj. Flow (vph)	9	42	130	1331	952	10
Shared Lane Traffic (%)						
Lane Group Flow (vph)	9	42	130	1331	962	0
Enter Blocked Intersection	No	No	No	No	No	No
Lane Alignment	Left	Right	Left	Left	Left	Right
Median Width(ft)	12			12	12	
Link Offset(ft)	0			0	0	
Crosswalk Width(ft)	16			16	16	
Two way Left Turn Lane						
Headway Factor	1.00	1.00	1.00	1.00	1.00	1.00
Turning Speed (mph)	60	60	60			60
Sign Control	Stop			Free	Free	

Intersection Summary

Area Type:	Other
Control Type:	Unsignalized
Intersection Capacity Utilization	44.2%
	ICU Level of Service A
Analysis Period (min)	15

Intersection						
Int Delay, s/veh	1.5					
Movement	EBL	EBR	NBL	NBT	SBT	SBR
Lane Configurations	↵	↶	↵	↑↑	↑↑↑	
Traffic Vol, veh/h	7	33	108	1238	876	8
Future Vol, veh/h	7	33	108	1238	876	8
Conflicting Peds, #/hr	0	0	0	0	0	0
Sign Control	Stop	Stop	Free	Free	Free	Free
RT Channelized	-	None	-	None	-	None
Storage Length	0	0	50	-	-	-
Veh in Median Storage, #	0	-	-	0	0	-
Grade, %	0	-	-	0	0	-
Peak Hour Factor	78	78	83	93	92	78
Heavy Vehicles, %	2	2	2	2	2	2
Mvmt Flow	9	42	130	1331	952	10

Major/Minor	Minor2	Major1	Major2			
Conflicting Flow All	1883	481	962	0	-	0
Stage 1	957	-	-	-	-	-
Stage 2	926	-	-	-	-	-
Critical Hdwy	6.29	7.14	5.34	-	-	-
Critical Hdwy Stg 1	6.64	-	-	-	-	-
Critical Hdwy Stg 2	5.84	-	-	-	-	-
Follow-up Hdwy	3.67	3.92	3.12	-	-	-
Pot Cap-1 Maneuver	82	454	408	-	-	-
Stage 1	263	-	-	-	-	-
Stage 2	337	-	-	-	-	-
Platoon blocked, %				-	-	-
Mov Cap-1 Maneuver	56	454	408	-	-	-
Mov Cap-2 Maneuver	56	-	-	-	-	-
Stage 1	179	-	-	-	-	-
Stage 2	337	-	-	-	-	-

Approach	EB	NB	SB
HCM Control Delay, s	25.5	1.6	0
HCM LOS	D		

Minor Lane/Major Mvmt	NBL	NBT	EBLn1	EBLn2	SBT	SBR
Capacity (veh/h)	408	-	56	454	-	-
HCM Lane V/C Ratio	0.319	-	0.16	0.093	-	-
HCM Control Delay (s)	17.9	-	81.2	13.7	-	-
HCM Lane LOS	C	-	F	B	-	-
HCM 95th %tile Q(veh)	1.4	-	0.5	0.3	-	-

Lanes, Volumes, Timings
1: Walden Street & 104th Avenue

JR Engineering
09/21/2023

Lane Group	EBL	EBT	EBR	WBL	WBT	WBR	NBL	NBT	NBR	SBL	SBT	SBR
Lane Configurations												
Traffic Volume (vph)	80	759	82	17	363	96	134	36	68	173	34	86
Future Volume (vph)	80	759	82	17	363	96	134	36	68	173	34	86
Ideal Flow (vphpl)	1900	1900	1900	1900	1900	1900	1900	1900	1900	1900	1900	1900
Storage Length (ft)	400		250	250		0	220		220	210		130
Storage Lanes	1		1	1		1	1		1	1		1
Taper Length (ft)	25			25			25			25		
Lane Util. Factor	1.00	0.95	1.00	1.00	0.95	1.00	1.00	1.00	1.00	1.00	1.00	1.00
Frt			0.850			0.850			0.850			0.850
Flt Protected	0.950			0.950			0.950			0.950		
Satd. Flow (prot)	1770	3539	1583	1770	3539	1583	1770	1863	1583	1770	1863	1583
Flt Permitted	0.461			0.298			0.728			0.403		
Satd. Flow (perm)	859	3539	1583	555	3539	1583	1356	1863	1583	751	1863	1583
Right Turn on Red			Yes			Yes			Yes			Yes
Satd. Flow (RTOR)			218			218			227			168
Link Speed (mph)		45			45			30				30
Link Distance (ft)		149			767			699				204
Travel Time (s)		2.3			11.6			15.9				4.6
Peak Hour Factor	0.80	0.92	0.80	0.78	0.88	0.80	0.84	0.78	0.79	0.84	0.78	0.79
Adj. Flow (vph)	100	825	103	22	413	120	160	46	86	206	44	109
Shared Lane Traffic (%)												
Lane Group Flow (vph)	100	825	103	22	413	120	160	46	86	206	44	109
Enter Blocked Intersection	No	No	No	No	No	No	No	No	No	No	No	No
Lane Alignment	Left	Left	Right	Left	Left	Right	Left	Left	Right	Left	Left	Right
Median Width(ft)		12			12			12				12
Link Offset(ft)		0			0			0				0
Crosswalk Width(ft)		16			16			16				16
Two way Left Turn Lane												
Headway Factor	1.00	1.00	1.00	1.00	1.00	1.00	1.00	1.00	1.00	1.00	1.00	1.00
Turning Speed (mph)	15		9	15		9	15		9	15		9
Number of Detectors	1	2	1	1	2	1	1	2	1	1	2	1
Detector Template	Left	Thru	Right	Left	Thru	Right	Left	Thru	Right	Left	Thru	Right
Leading Detector (ft)	20	100	20	20	100	20	20	100	20	20	100	20
Trailing Detector (ft)	0	0	0	0	0	0	0	0	0	0	0	0
Detector 1 Position(ft)	0	0	0	0	0	0	0	0	0	0	0	0
Detector 1 Size(ft)	20	6	20	20	6	20	20	6	20	20	6	20
Detector 1 Type	Cl+Ex	Cl+Ex	Cl+Ex	Cl+Ex	Cl+Ex	Cl+Ex	Cl+Ex	Cl+Ex	Cl+Ex	Cl+Ex	Cl+Ex	Cl+Ex
Detector 1 Channel												
Detector 1 Extend (s)	0.0	0.0	0.0	0.0	0.0	0.0	0.0	0.0	0.0	0.0	0.0	0.0
Detector 1 Queue (s)	0.0	0.0	0.0	0.0	0.0	0.0	0.0	0.0	0.0	0.0	0.0	0.0
Detector 1 Delay (s)	0.0	0.0	0.0	0.0	0.0	0.0	0.0	0.0	0.0	0.0	0.0	0.0
Detector 2 Position(ft)		94			94			94				94
Detector 2 Size(ft)		6			6			6				6
Detector 2 Type		Cl+Ex			Cl+Ex			Cl+Ex				Cl+Ex
Detector 2 Channel												
Detector 2 Extend (s)		0.0			0.0			0.0				0.0
Turn Type	pm+pt	NA	Perm	pm+pt	NA	Perm	pm+pt	NA	Perm	pm+pt	NA	Perm
Protected Phases	5	2		1	6		3	8		7	4	
Permitted Phases	2		2	6		6	8		8	4		4

Lanes, Volumes, Timings
1: Walden Street & 104th Avenue



Lane Group	EBL	EBT	EBR	WBL	WBT	WBR	NBL	NBT	NBR	SBL	SBT	SBR
Detector Phase	5	2	2	1	6	6	3	8	8	7	4	4
Switch Phase												
Minimum Initial (s)	5.0	10.0	10.0	5.0	10.0	10.0	8.0	10.0	10.0	8.0	10.0	10.0
Minimum Split (s)	12.5	17.5	17.5	12.5	17.5	17.5	14.5	16.5	16.5	14.5	16.5	16.5
Total Split (s)	19.0	50.0	50.0	13.0	44.0	44.0	20.0	17.0	17.0	40.0	37.0	37.0
Total Split (%)	15.8%	41.7%	41.7%	10.8%	36.7%	36.7%	16.7%	14.2%	14.2%	33.3%	30.8%	30.8%
Maximum Green (s)	11.5	42.5	42.5	5.5	36.5	36.5	13.5	10.5	10.5	33.5	30.5	30.5
Yellow Time (s)	5.3	5.3	5.3	5.3	5.3	5.3	3.8	3.8	3.8	3.8	3.8	3.8
All-Red Time (s)	2.2	2.2	2.2	2.2	2.2	2.2	2.7	2.7	2.7	2.7	2.7	2.7
Lost Time Adjust (s)	0.0	0.0	0.0	0.0	0.0	0.0	0.0	0.0	0.0	0.0	0.0	0.0
Total Lost Time (s)	7.5	7.5	7.5	7.5	7.5	7.5	6.5	6.5	6.5	6.5	6.5	6.5
Lead/Lag	Lead	Lag	Lag	Lead	Lag	Lag	Lead	Lag	Lag	Lead	Lag	Lag
Lead-Lag Optimize?	Yes	Yes	Yes	Yes	Yes	Yes	Yes	Yes	Yes	Yes	Yes	Yes
Vehicle Extension (s)	3.0	5.0	5.0	3.0	5.0	5.0	2.0	2.0	2.0	2.0	2.0	2.0
Recall Mode	None	C-Max	C-Max	None	C-Max	C-Max	None	None	None	None	None	None
Act Effct Green (s)	70.4	64.7	64.7	63.3	57.1	57.1	20.3	10.1	10.1	31.2	14.2	14.2
Actuated g/C Ratio	0.59	0.54	0.54	0.53	0.48	0.48	0.17	0.08	0.08	0.26	0.12	0.12
v/c Ratio	0.18	0.43	0.11	0.06	0.25	0.14	0.59	0.29	0.25	0.57	0.20	0.33
Control Delay	11.7	19.6	0.2	3.4	8.2	1.7	44.9	56.9	1.8	41.3	48.2	3.6
Queue Delay	0.0	0.0	0.0	0.0	0.0	0.0	0.0	0.0	0.0	0.0	0.0	0.0
Total Delay	11.7	19.6	0.2	3.4	8.2	1.7	44.9	56.9	1.8	41.3	48.2	3.6
LOS	B	B	A	A	A	A	D	E	A	D	D	A
Approach Delay		16.9			6.6			34.1			30.7	
Approach LOS		B			A			C			C	

Intersection Summary

Area Type:	Other
Cycle Length:	120
Actuated Cycle Length:	120
Offset:	10 (8%), Referenced to phase 2:EBTL and 6:WBTL, Start of Yellow
Natural Cycle:	70
Control Type:	Actuated-Coordinated
Maximum v/c Ratio:	0.59
Intersection Signal Delay:	18.8
Intersection LOS:	B
Intersection Capacity Utilization:	59.3%
ICU Level of Service:	B
Analysis Period (min):	15

Splits and Phases: 1: Walden Street & 104th Avenue



Queues
1: Walden Street & 104th Avenue



Lane Group	EBL	EBT	EBR	WBL	WBT	WBR	NBL	NBT	NBR	SBL	SBT	SBR
Lane Group Flow (vph)	100	825	103	22	413	120	160	46	86	206	44	109
v/c Ratio	0.18	0.43	0.11	0.06	0.25	0.14	0.59	0.29	0.25	0.57	0.20	0.33
Control Delay	11.7	19.6	0.2	3.4	8.2	1.7	44.9	56.9	1.8	41.3	48.2	3.6
Queue Delay	0.0	0.0	0.0	0.0	0.0	0.0	0.0	0.0	0.0	0.0	0.0	0.0
Total Delay	11.7	19.6	0.2	3.4	8.2	1.7	44.9	56.9	1.8	41.3	48.2	3.6
Queue Length 50th (ft)	30	213	0	1	57	0	99	34	0	131	32	0
Queue Length 95th (ft)	56	310	0	m8	76	0	136	63	0	171	55	0
Internal Link Dist (ft)		69			687			619			124	
Turn Bay Length (ft)	400		250	250			220		220	210		130
Base Capacity (vph)	599	1907	953	355	1685	867	290	163	345	505	473	527
Starvation Cap Reductn	0	0	0	0	0	0	0	0	0	0	0	0
Spillback Cap Reductn	0	0	0	0	0	0	0	0	0	0	0	0
Storage Cap Reductn	0	0	0	0	0	0	0	0	0	0	0	0
Reduced v/c Ratio	0.17	0.43	0.11	0.06	0.25	0.14	0.55	0.28	0.25	0.41	0.09	0.21

Intersection Summary

m Volume for 95th percentile queue is metered by upstream signal.

HCM 6th Signalized Intersection Summary
 1: Walden Street & 104th Avenue



Movement	EBL	EBT	EBR	WBL	WBT	WBR	NBL	NBT	NBR	SBL	SBT	SBR
Lane Configurations	↖	↗	↘	↖	↗	↘	↖	↗	↘	↖	↗	↘
Traffic Volume (veh/h)	80	759	82	17	363	96	134	36	68	173	34	86
Future Volume (veh/h)	80	759	82	17	363	96	134	36	68	173	34	86
Initial Q (Qb), veh	0	0	0	0	0	0	0	0	0	0	0	0
Ped-Bike Adj(A_pbT)	1.00		1.00	1.00		1.00	1.00		1.00	1.00		1.00
Parking Bus, Adj	1.00	1.00	1.00	1.00	1.00	1.00	1.00	1.00	1.00	1.00	1.00	1.00
Work Zone On Approach		No			No			No			No	
Adj Sat Flow, veh/h/ln	1870	1870	1870	1870	1870	1870	1870	1870	1870	1870	1870	1870
Adj Flow Rate, veh/h	100	825	102	22	412	120	160	46	86	206	44	109
Peak Hour Factor	0.80	0.92	0.80	0.78	0.88	0.80	0.84	0.78	0.79	0.84	0.78	0.79
Percent Heavy Veh, %	2	2	2	2	2	2	2	2	2	2	2	2
Cap, veh/h	500	1916	855	340	1843	822	336	156	132	354	203	172
Arrive On Green	0.04	0.54	0.54	0.01	0.17	0.17	0.10	0.08	0.08	0.12	0.11	0.11
Sat Flow, veh/h	1781	3554	1585	1781	3554	1585	1781	1870	1585	1781	1870	1585
Grp Volume(v), veh/h	100	825	102	22	412	120	160	46	86	206	44	109
Grp Sat Flow(s),veh/h/ln	1781	1777	1585	1781	1777	1585	1781	1870	1585	1781	1870	1585
Q Serve(g_s), s	3.1	16.7	3.8	0.7	12.0	7.7	9.7	2.8	6.3	12.5	2.6	7.9
Cycle Q Clear(g_c), s	3.1	16.7	3.8	0.7	12.0	7.7	9.7	2.8	6.3	12.5	2.6	7.9
Prop In Lane	1.00		1.00	1.00		1.00	1.00		1.00	1.00		1.00
Lane Grp Cap(c), veh/h	500	1916	855	340	1843	822	336	156	132	354	203	172
V/C Ratio(X)	0.20	0.43	0.12	0.06	0.22	0.15	0.48	0.30	0.65	0.58	0.22	0.63
Avail Cap(c_a), veh/h	596	1916	855	383	1843	822	363	164	139	633	475	403
HCM Platoon Ratio	1.00	1.00	1.00	0.33	0.33	0.33	1.00	1.00	1.00	1.00	1.00	1.00
Upstream Filter(I)	1.00	1.00	1.00	1.00	1.00	1.00	1.00	1.00	1.00	1.00	1.00	1.00
Uniform Delay (d), s/veh	12.9	16.6	13.6	13.9	28.9	27.1	44.2	51.7	53.3	42.8	48.8	51.2
Incr Delay (d2), s/veh	0.2	0.7	0.3	0.1	0.3	0.4	0.4	0.4	7.3	0.6	0.2	1.4
Initial Q Delay(d3),s/veh	0.0	0.0	0.0	0.0	0.0	0.0	0.0	0.0	0.0	0.0	0.0	0.0
%ile BackOfQ(50%),veh/ln	1.2	6.5	1.4	0.3	5.6	3.2	4.3	1.3	2.8	5.5	1.2	3.2
Unsig. Movement Delay, s/veh												
LnGrp Delay(d),s/veh	13.1	17.3	13.9	14.0	29.2	27.5	44.6	52.1	60.6	43.4	49.0	52.6
LnGrp LOS	B	B	B	B	C	C	D	D	E	D	D	D
Approach Vol, veh/h		1027			554			292			359	
Approach Delay, s/veh		16.6			28.2			50.5			46.9	
Approach LOS		B			C			D			D	
Timer - Assigned Phs	1	2	3	4	5	6	7	8				
Phs Duration (G+Y+Rc), s	10.1	72.2	18.2	19.5	12.5	69.7	21.2	16.5				
Change Period (Y+Rc), s	* 7.5	* 7.5	6.5	6.5	* 7.5	* 7.5	6.5	6.5				
Max Green Setting (Gmax), s	* 5.5	* 43	13.5	30.5	* 12	* 37	33.5	10.5				
Max Q Clear Time (g_c+I1), s	2.7	18.7	11.7	9.9	5.1	14.0	14.5	8.3				
Green Ext Time (p_c), s	0.0	10.7	0.0	0.3	0.1	5.4	0.3	0.1				

Intersection Summary

HCM 6th Ctrl Delay	28.8
HCM 6th LOS	C

Notes

* HCM 6th computational engine requires equal clearance times for the phases crossing the barrier.

Lanes, Volumes, Timings
2: Yampa Street & 104th Avenue



Lane Group	EBT	EBR	WBL	WBT	NBL	NBR
Lane Configurations	↑↑↑	↑	↓	↑↑↑		↓
Traffic Volume (vph)	1023	15	12	496	0	15
Future Volume (vph)	1023	15	12	496	0	15
Ideal Flow (vphpl)	1900	1900	1900	1900	1900	1900
Storage Length (ft)		50	50		0	0
Storage Lanes		1	1		0	1
Taper Length (ft)			25		25	
Lane Util. Factor	0.91	1.00	1.00	0.91	1.00	1.00
Frt		0.850				0.865
Flt Protected			0.950			
Satd. Flow (prot)	5085	1583	1770	5085	0	1611
Flt Permitted			0.950			
Satd. Flow (perm)	5085	1583	1770	5085	0	1611
Link Speed (mph)	35			45	30	
Link Distance (ft)	767			1110	440	
Travel Time (s)	14.9			16.8	10.0	
Peak Hour Factor	0.93	0.78	0.78	0.88	0.78	0.78
Adj. Flow (vph)	1100	19	15	564	0	19
Shared Lane Traffic (%)						
Lane Group Flow (vph)	1100	19	15	564	0	19
Enter Blocked Intersection	No	No	No	No	No	No
Lane Alignment	Left	Right	Left	Left	Left	Right
Median Width(ft)	12			12	0	
Link Offset(ft)	0			0	0	
Crosswalk Width(ft)	16			16	16	
Two way Left Turn Lane						
Headway Factor	1.00	1.00	1.00	1.00	1.00	1.00
Turning Speed (mph)		9	15		15	9
Sign Control	Free			Free	Stop	

Intersection Summary

Area Type:	Other
Control Type:	Unsignalized
Intersection Capacity Utilization	29.8%
	ICU Level of Service A
Analysis Period (min)	15

Intersection						
Int Delay, s/veh	0.3					
Movement	EBT	EBR	WBL	WBT	NBL	NBR
Lane Configurations	↑↑↑	↑	↑	↑↑↑		↑
Traffic Vol, veh/h	1023	15	12	496	0	15
Future Vol, veh/h	1023	15	12	496	0	15
Conflicting Peds, #/hr	0	0	0	0	0	0
Sign Control	Free	Free	Free	Free	Stop	Stop
RT Channelized	-	None	-	None	-	None
Storage Length	-	50	50	-	-	0
Veh in Median Storage, #	0	-	-	0	0	-
Grade, %	0	-	-	0	0	-
Peak Hour Factor	93	78	78	88	78	78
Heavy Vehicles, %	2	2	2	2	2	2
Mvmt Flow	1100	19	15	564	0	19

Major/Minor	Major1	Major2	Minor1		
Conflicting Flow All	0	0	1119	0	- 550
Stage 1	-	-	-	-	-
Stage 2	-	-	-	-	-
Critical Hdwy	-	-	5.34	-	- 7.14
Critical Hdwy Stg 1	-	-	-	-	-
Critical Hdwy Stg 2	-	-	-	-	-
Follow-up Hdwy	-	-	3.12	-	- 3.92
Pot Cap-1 Maneuver	-	-	343	-	0 410
Stage 1	-	-	-	-	0 -
Stage 2	-	-	-	-	0 -
Platoon blocked, %	-	-	-	-	-
Mov Cap-1 Maneuver	-	-	343	-	- 410
Mov Cap-2 Maneuver	-	-	-	-	-
Stage 1	-	-	-	-	-
Stage 2	-	-	-	-	-

Approach	EB	WB	NB
HCM Control Delay, s	0	0.4	14.2
HCM LOS			B

Minor Lane/Major Mvmt	NBLn1	EBT	EBR	WBL	WBT
Capacity (veh/h)	410	-	-	343	-
HCM Lane V/C Ratio	0.047	-	-	0.045	-
HCM Control Delay (s)	14.2	-	-	16	-
HCM Lane LOS	B	-	-	C	-
HCM 95th %tile Q(veh)	0.1	-	-	0.1	-

Lanes, Volumes, Timings
3: Tower Road & 104th Avenue

Lane Group	EBL	EBT	EBR	WBL	WBT	WBR	NBL	NBT	NBR	SBL	SBT	SBR
Lane Configurations												
Traffic Volume (vph)	127	301	593	31	100	6	297	476	59	15	636	100
Future Volume (vph)	127	301	593	31	100	6	297	476	59	15	636	100
Ideal Flow (vphp)	1900	1900	1900	1900	1900	1900	1900	1900	1900	1900	1900	1900
Storage Length (ft)	420		0	475		300	160		0	250		0
Storage Lanes	1		1	1		1	2		1	1		1
Taper Length (ft)	25			25			25			25		
Lane Util. Factor	1.00	0.91	1.00	1.00	0.91	1.00	0.97	0.95	1.00	1.00	0.95	1.00
Frt			0.850			0.850			0.850			0.850
Flt Protected	0.950			0.950			0.950			0.950		
Satd. Flow (prot)	1770	5085	1583	1770	5085	1583	3433	3539	1583	1770	3539	1583
Flt Permitted	0.488			0.538			0.950			0.950		
Satd. Flow (perm)	909	5085	1583	1002	5085	1583	3433	3539	1583	1770	3539	1583
Right Turn on Red			Yes			Yes			Yes			Yes
Satd. Flow (RTOR)			571			264			182			256
Link Speed (mph)		45			45			50			50	
Link Distance (ft)		1110			840			620			1000	
Travel Time (s)		16.8			12.7			8.5			13.6	
Peak Hour Factor	0.84	0.88	0.92	0.78	0.83	0.78	0.88	0.88	0.79	0.78	0.92	0.83
Adj. Flow (vph)	151	342	645	40	120	8	338	541	75	19	691	120
Shared Lane Traffic (%)												
Lane Group Flow (vph)	151	342	645	40	120	8	338	541	75	19	691	120
Enter Blocked Intersection	No	No	No	No	No	No	No	No	No	No	No	No
Lane Alignment	Left	Left	Right	Left	Left	Right	Left	Left	Right	Left	Left	Right
Median Width(ft)		12			12			24			24	
Link Offset(ft)		0			0			0			0	
Crosswalk Width(ft)		16			16			16			16	
Two way Left Turn Lane												
Headway Factor	1.00	1.00	1.00	1.00	1.00	1.00	1.00	1.00	1.00	1.00	1.00	1.00
Turning Speed (mph)	15		9	15		9	15		9	15		9
Number of Detectors	1	1	1	1	1	1	1	1	1	1	1	1
Detector Template	Left	Thru	Right	Left	Thru	Right	Left	Thru	Right	Left	Thru	Right
Leading Detector (ft)	40	40	40	40	40	40	40	40	40	40	40	40
Trailing Detector (ft)	0	0	0	0	0	0	0	0	0	0	0	0
Detector 1 Position(ft)	0	0	0	0	0	0	0	0	0	0	0	0
Detector 1 Size(ft)	40	40	40	40	40	40	40	40	40	40	40	40
Detector 1 Type	Cl+Ex	Cl+Ex	Cl+Ex	Cl+Ex	Cl+Ex	Cl+Ex	Cl+Ex	Cl+Ex	Cl+Ex	Cl+Ex	Cl+Ex	Cl+Ex
Detector 1 Channel												
Detector 1 Extend (s)	0.0	0.0	0.0	0.0	0.0	0.0	0.0	0.0	0.0	0.0	0.0	0.0
Detector 1 Queue (s)	0.0	0.0	0.0	0.0	0.0	0.0	0.0	0.0	0.0	0.0	0.0	0.0
Detector 1 Delay (s)	0.0	0.0	0.0	0.0	0.0	0.0	0.0	0.0	0.0	0.0	0.0	0.0
Turn Type	pm+pt	NA	Perm	pm+pt	NA	Perm	Prot	NA	Perm	Prot	NA	Perm
Protected Phases	7	4		3	8		5	2		1	6	
Permitted Phases	4		4	8		8			2			6
Detector Phase	7	4	4	3	8	8	5	2	2	1	6	6
Switch Phase												
Minimum Initial (s)	8.0	10.0	10.0	8.0	10.0	10.0	8.0	10.0	10.0	8.0	10.0	10.0
Minimum Split (s)	15.4	38.0	38.0	15.4	36.0	36.0	16.2	39.0	39.0	16.2	30.0	30.0
Total Split (s)	20.0	38.0	38.0	18.0	36.0	36.0	34.0	39.0	39.0	25.0	30.0	30.0

Lanes, Volumes, Timings
3: Tower Road & 104th Avenue



Lane Group	EBL	EBT	EBR	WBL	WBT	WBR	NBL	NBT	NBR	SBL	SBT	SBR
Total Split (%)	16.7%	31.7%	31.7%	15.0%	30.0%	30.0%	28.3%	32.5%	32.5%	20.8%	25.0%	25.0%
Maximum Green (s)	12.6	30.6	30.6	10.6	28.6	28.6	25.8	30.8	30.8	16.8	21.8	21.8
Yellow Time (s)	5.0	5.0	5.0	5.0	5.0	5.0	5.1	5.1	5.1	5.1	5.1	5.1
All-Red Time (s)	2.4	2.4	2.4	2.4	2.4	2.4	3.1	3.1	3.1	3.1	3.1	3.1
Lost Time Adjust (s)	0.0	0.0	0.0	0.0	0.0	0.0	0.0	0.0	0.0	0.0	0.0	0.0
Total Lost Time (s)	7.4	7.4	7.4	7.4	7.4	7.4	8.2	8.2	8.2	8.2	8.2	8.2
Lead/Lag	Lead	Lag	Lag	Lead	Lag	Lag	Lead	Lag	Lag	Lead	Lag	Lag
Lead-Lag Optimize?	Yes	Yes	Yes	Yes	Yes	Yes	Yes	Yes	Yes	Yes	Yes	Yes
Vehicle Extension (s)	2.0	2.0	2.0	2.0	2.0	2.0	2.0	5.0	5.0	2.0	5.0	5.0
Recall Mode	None	None	None	None	None	None	None	C-Min	C-Min	None	C-Min	C-Min
Act Effct Green (s)	32.8	25.2	25.2	23.3	15.3	15.3	16.2	63.5	63.5	8.0	45.6	45.6
Actuated g/C Ratio	0.27	0.21	0.21	0.19	0.13	0.13	0.14	0.53	0.53	0.07	0.38	0.38
v/c Ratio	0.45	0.32	0.82	0.16	0.18	0.02	0.73	0.29	0.08	0.16	0.51	0.16
Control Delay	30.4	36.4	26.0	29.9	45.3	0.0	59.3	19.5	0.2	56.3	32.9	0.4
Queue Delay	0.0	0.0	0.0	0.0	0.0	0.0	0.0	0.0	0.0	0.0	0.0	0.0
Total Delay	30.4	36.4	26.0	29.9	45.3	0.0	59.3	19.5	0.2	56.3	32.9	0.4
LOS	C	D	C	C	D	A	E	B	A	E	C	A
Approach Delay		29.7			39.5			32.1			28.8	
Approach LOS		C			D			C			C	

Intersection Summary

Area Type: Other
 Cycle Length: 120
 Actuated Cycle Length: 120
 Offset: 0 (0%), Referenced to phase 2:NBT and 6:SBT, Start of Yellow, Master Intersection
 Natural Cycle: 110
 Control Type: Actuated-Coordinated
 Maximum v/c Ratio: 0.82
 Intersection Signal Delay: 30.7
 Intersection LOS: C
 Intersection Capacity Utilization 80.1%
 ICU Level of Service D
 Analysis Period (min) 15

Splits and Phases: 3: Tower Road & 104th Avenue

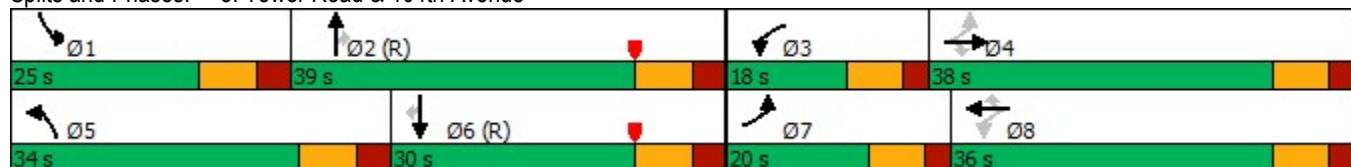

Queues
3: Tower Road & 104th Avenue



Lane Group	EBL	EBT	EBR	WBL	WBT	WBR	NBL	NBT	NBR	SBL	SBT	SBR
Lane Group Flow (vph)	151	342	645	40	120	8	338	541	75	19	691	120
v/c Ratio	0.45	0.32	0.82	0.16	0.18	0.02	0.73	0.29	0.08	0.16	0.51	0.16
Control Delay	30.4	36.4	26.0	29.9	45.3	0.0	59.3	19.5	0.2	56.3	32.9	0.4
Queue Delay	0.0	0.0	0.0	0.0	0.0	0.0	0.0	0.0	0.0	0.0	0.0	0.0
Total Delay	30.4	36.4	26.0	29.9	45.3	0.0	59.3	19.5	0.2	56.3	32.9	0.4
Queue Length 50th (ft)	102	94	249	24	32	0	131	92	0	14	201	0
Queue Length 95th (ft)	110	111	405	36	41	0	170	221	0	34	#370	0
Internal Link Dist (ft)		1030			760			540			920	
Turn Bay Length (ft)	420			475		300	160			250		
Base Capacity (vph)	338	1318	833	284	1211	578	738	1871	922	247	1344	759
Starvation Cap Reductn	0	0	0	0	0	0	0	0	0	0	0	0
Spillback Cap Reductn	0	0	0	0	0	0	0	0	0	0	0	0
Storage Cap Reductn	0	0	0	0	0	0	0	0	0	0	0	0
Reduced v/c Ratio	0.45	0.26	0.77	0.14	0.10	0.01	0.46	0.29	0.08	0.08	0.51	0.16

Intersection Summary

95th percentile volume exceeds capacity, queue may be longer.
Queue shown is maximum after two cycles.

HCM 6th Signalized Intersection Summary
3: Tower Road & 104th Avenue



Movement	EBL	EBT	EBR	WBL	WBT	WBR	NBL	NBT	NBR	SBL	SBT	SBR
Lane Configurations	↘	↑↑↑	↗	↘	↑↑↑	↗	↘↗	↑↑	↗	↘	↑↑	↗
Traffic Volume (veh/h)	127	301	593	31	100	6	297	476	59	15	636	100
Future Volume (veh/h)	127	301	593	31	100	6	297	476	59	15	636	100
Initial Q (Qb), veh	0	0	0	0	0	0	0	0	0	0	0	0
Ped-Bike Adj(A_pbT)	1.00		1.00	1.00		1.00	1.00		1.00	1.00		1.00
Parking Bus, Adj	1.00	1.00	1.00	1.00	1.00	1.00	1.00	1.00	1.00	1.00	1.00	1.00
Work Zone On Approach		No			No			No			No	
Adj Sat Flow, veh/h/ln	1870	1870	1870	1870	1870	1870	1870	1870	1870	1870	1870	1870
Adj Flow Rate, veh/h	151	342	0	40	120	0	338	541	0	19	691	0
Peak Hour Factor	0.84	0.88	0.92	0.78	0.83	0.78	0.88	0.88	0.79	0.78	0.92	0.83
Percent Heavy Veh, %	2	2	2	2	2	2	2	2	2	2	2	2
Cap, veh/h	304	650		212	426		406	1892		56	1586	
Arrive On Green	0.03	0.04	0.00	0.05	0.08	0.00	0.12	0.53	0.00	0.03	0.45	0.00
Sat Flow, veh/h	1781	5106	1585	1781	5106	1585	3456	3554	1585	1781	3554	1585
Grp Volume(v), veh/h	151	342	0	40	120	0	338	541	0	19	691	0
Grp Sat Flow(s),veh/h/ln	1781	1702	1585	1781	1702	1585	1728	1777	1585	1781	1777	1585
Q Serve(g_s), s	9.2	7.9	0.0	2.4	2.6	0.0	11.5	10.1	0.0	1.3	16.0	0.0
Cycle Q Clear(g_c), s	9.2	7.9	0.0	2.4	2.6	0.0	11.5	10.1	0.0	1.3	16.0	0.0
Prop In Lane	1.00		1.00	1.00		1.00	1.00		1.00	1.00		1.00
Lane Grp Cap(c), veh/h	304	650		212	426		406	1892		56	1586	
V/C Ratio(X)	0.50	0.53		0.19	0.28		0.83	0.29		0.34	0.44	
Avail Cap(c_a), veh/h	325	1302		281	1217		743	1892		249	1586	
HCM Platoon Ratio	0.33	0.33	0.33	1.00	1.00	1.00	1.00	1.00	1.00	1.00	1.00	1.00
Upstream Filter(I)	1.00	1.00	0.00	1.00	1.00	0.00	1.00	1.00	0.00	1.00	1.00	0.00
Uniform Delay (d), s/veh	47.6	53.9	0.0	46.2	51.6	0.0	51.8	15.5	0.0	56.9	22.8	0.0
Incr Delay (d2), s/veh	0.5	0.2	0.0	0.2	0.1	0.0	1.7	0.4	0.0	1.3	0.9	0.0
Initial Q Delay(d3),s/veh	0.0	0.0	0.0	0.0	0.0	0.0	0.0	0.0	0.0	0.0	0.0	0.0
%ile BackOfQ(50%),veh/ln	4.3	3.5	0.0	1.0	1.1	0.0	4.9	3.9	0.0	0.6	6.5	0.0
Unsig. Movement Delay, s/veh												
LnGrp Delay(d),s/veh	48.1	54.2	0.0	46.4	51.8	0.0	53.6	15.9	0.0	58.2	23.7	0.0
LnGrp LOS	D	D		D	D		D	B		E	C	
Approach Vol, veh/h		493			160			879			710	
Approach Delay, s/veh		52.3			50.4			30.4			24.6	
Approach LOS		D			D			C			C	
Timer - Assigned Phs	1	2	3	4	5	6	7	8				
Phs Duration (G+Y+Rc), s	12.0	72.1	13.3	22.7	22.3	61.7	18.6	17.4				
Change Period (Y+Rc), s	8.2	8.2	7.4	7.4	8.2	8.2	7.4	7.4				
Max Green Setting (Gmax), s	16.8	30.8	10.6	30.6	25.8	21.8	12.6	28.6				
Max Q Clear Time (g_c+I1), s	3.3	12.1	4.4	9.9	13.5	18.0	11.2	4.6				
Green Ext Time (p_c), s	0.0	4.3	0.0	0.7	0.6	1.8	0.0	0.2				

Intersection Summary

HCM 6th Ctrl Delay	34.8
HCM 6th LOS	C

Notes

User approved pedestrian interval to be less than phase max green.
Unsignalized Delay for [NBR, EBR, WBR, SBR] is excluded from calculations of the approach delay and intersection delay.

Lanes, Volumes, Timings
4: Tower Road & Private Access



Lane Group	EBL	EBR	NBL	NBT	SBT	SBR
Lane Configurations						
Traffic Volume (vph)	0	21	0	767	1149	63
Future Volume (vph)	0	21	0	767	1149	63
Ideal Flow (vphpl)	1900	1900	1900	1900	1900	1900
Lane Util. Factor	1.00	1.00	1.00	0.95	0.91	0.91
Fr _t		0.865			0.991	
Fl _t Protected						
Satd. Flow (prot)	0	1611	0	3539	5040	0
Fl _t Permitted						
Satd. Flow (perm)	0	1611	0	3539	5040	0
Link Speed (mph)	30			50	30	
Link Distance (ft)	345			530	620	
Travel Time (s)	7.8			7.2	14.1	
Peak Hour Factor	0.78	0.78	0.78	0.92	0.93	0.80
Adj. Flow (vph)	0	27	0	834	1235	79
Shared Lane Traffic (%)						
Lane Group Flow (vph)	0	27	0	834	1314	0
Enter Blocked Intersection	No	No	No	No	No	No
Lane Alignment	Left	Right	Left	Left	Left	Right
Median Width(ft)	0			24	24	
Link Offset(ft)	0			0	0	
Crosswalk Width(ft)	16			16	16	
Two way Left Turn Lane						
Headway Factor	1.00	1.00	1.00	1.00	1.00	1.00
Turning Speed (mph)	15	9	15			9
Sign Control	Stop			Free	Free	

Intersection Summary

Area Type:	Other
Control Type:	Unsignalized
Intersection Capacity Utilization	33.6%
ICU Level of Service	A
Analysis Period (min)	15

Intersection						
Int Delay, s/veh	0.2					
Movement	EBL	EBR	NBL	NBT	SBT	SBR
Lane Configurations		↗		↑↑	↑↑↑	
Traffic Vol, veh/h	0	21	0	767	1149	63
Future Vol, veh/h	0	21	0	767	1149	63
Conflicting Peds, #/hr	0	0	0	0	0	0
Sign Control	Stop	Stop	Free	Free	Free	Free
RT Channelized	-	None	-	None	-	None
Storage Length	-	0	-	-	-	-
Veh in Median Storage, #	0	-	-	0	0	-
Grade, %	0	-	-	0	0	-
Peak Hour Factor	78	78	78	92	93	80
Heavy Vehicles, %	2	2	2	2	2	2
Mvmt Flow	0	27	0	834	1235	79

Major/Minor	Minor2	Major1	Major2		
Conflicting Flow All	-	657	-	0	-
Stage 1	-	-	-	-	-
Stage 2	-	-	-	-	-
Critical Hdwy	-	7.14	-	-	-
Critical Hdwy Stg 1	-	-	-	-	-
Critical Hdwy Stg 2	-	-	-	-	-
Follow-up Hdwy	-	3.92	-	-	-
Pot Cap-1 Maneuver	0	349	0	-	-
Stage 1	0	-	0	-	-
Stage 2	0	-	0	-	-
Platoon blocked, %				-	-
Mov Cap-1 Maneuver	-	349	-	-	-
Mov Cap-2 Maneuver	-	-	-	-	-
Stage 1	-	-	-	-	-
Stage 2	-	-	-	-	-

Approach	EB	NB	SB
HCM Control Delay, s	16.2	0	0
HCM LOS	C		

Minor Lane/Major Mvmt	NBT	EBLn1	SBT	SBR
Capacity (veh/h)	-	349	-	-
HCM Lane V/C Ratio	-	0.077	-	-
HCM Control Delay (s)	-	16.2	-	-
HCM Lane LOS	-	C	-	-
HCM 95th %tile Q(veh)	-	0.2	-	-

Lanes, Volumes, Timings
5: 103rd Avenue & Tower Road

JR Engineering
09/21/2023



Lane Group	EBL	EBT	EBR	WBL	WBT	WBR	NBL	NBT	NBR	SBL	SBT	SBR
Lane Configurations												
Traffic Volume (vph)	1	1	34	15	1	59	57	747	11	62	1169	15
Future Volume (vph)	1	1	34	15	1	59	57	747	11	62	1169	15
Ideal Flow (vphpl)	1900	1900	1900	1900	1900	1900	1900	1900	1900	1900	1900	1900
Storage Length (ft)	45		0	100		0	440		185	130		0
Storage Lanes	1		0	1		0	1		0	1		0
Taper Length (ft)	25			25			25			25		
Lane Util. Factor	1.00	1.00	1.00	1.00	1.00	1.00	1.00	0.95	0.95	1.00	0.91	0.91
Frt		0.853			0.852			0.997			0.998	
Flt Protected	0.950			0.950			0.950			0.950		
Satd. Flow (prot)	1770	1589	0	1770	1587	0	1770	3529	0	1770	5075	0
Flt Permitted	0.950			0.950			0.950			0.950		
Satd. Flow (perm)	1770	1589	0	1770	1587	0	1770	3529	0	1770	5075	0
Link Speed (mph)		30			30			30			30	
Link Distance (ft)		875			708			356			530	
Travel Time (s)		19.9			16.1			8.1			12.0	
Peak Hour Factor	0.78	0.78	0.78	0.78	0.78	0.78	0.80	0.92	0.78	0.78	0.93	0.78
Adj. Flow (vph)	1	1	44	19	1	76	71	812	14	79	1257	19
Shared Lane Traffic (%)												
Lane Group Flow (vph)	1	45	0	19	77	0	71	826	0	79	1276	0
Enter Blocked Intersection	No	No	No	No	No	No	No	No	No	No	No	No
Lane Alignment	Left	Left	Right	Left	Left	Right	Left	Left	Right	Left	Left	Right
Median Width(ft)		12			12			12			12	
Link Offset(ft)		0			0			0			0	
Crosswalk Width(ft)		16			16			16			16	
Two way Left Turn Lane												
Headway Factor	1.00	1.00	1.00	1.00	1.00	1.00	1.00	1.00	1.00	1.00	1.00	1.00
Turning Speed (mph)	15		9	15		9	15		9	15		9
Sign Control		Stop			Stop			Free			Free	

Intersection Summary

Area Type:	Other
Control Type:	Unsignalized
Intersection Capacity Utilization	43.8%
ICU Level of Service	A
Analysis Period (min)	15

Intersection												
Int Delay, s/veh	2.8											
Movement	EBL	EBT	EBR	WBL	WBT	WBR	NBL	NBT	NBR	SBL	SBT	SBR
Lane Configurations	↵	↵		↵	↵		↵	↕		↵	↕	↕
Traffic Vol, veh/h	1	1	34	15	1	59	57	747	11	62	1169	15
Future Vol, veh/h	1	1	34	15	1	59	57	747	11	62	1169	15
Conflicting Peds, #/hr	0	0	0	0	0	0	0	0	0	0	0	0
Sign Control	Stop	Stop	Stop	Stop	Stop	Stop	Free	Free	Free	Free	Free	Free
RT Channelized	-	-	None	-	-	None	-	-	None	-	-	None
Storage Length	45	-	-	100	-	-	440	-	-	130	-	-
Veh in Median Storage, #	-	0	-	-	0	-	-	0	-	-	0	-
Grade, %	-	0	-	-	0	-	-	0	-	-	0	-
Peak Hour Factor	78	78	78	78	78	78	80	92	78	78	93	78
Heavy Vehicles, %	2	2	2	2	2	2	2	2	2	2	2	2
Mvmt Flow	1	1	44	19	1	76	71	812	14	79	1257	19

Major/Minor	Minor2		Minor1		Major1		Major2					
Conflicting Flow All	1974	2393	638	1622	2395	413	1276	0	0	826	0	0
Stage 1	1425	1425	-	961	961	-	-	-	-	-	-	-
Stage 2	549	968	-	661	1434	-	-	-	-	-	-	-
Critical Hdwy	6.99	6.54	7.14	6.99	6.54	6.94	5.34	-	-	4.14	-	-
Critical Hdwy Stg 1	7.34	5.54	-	6.54	5.54	-	-	-	-	-	-	-
Critical Hdwy Stg 2	6.54	5.54	-	6.74	5.54	-	-	-	-	-	-	-
Follow-up Hdwy	3.67	4.02	3.92	3.67	4.02	3.32	3.12	-	-	2.22	-	-
Pot Cap-1 Maneuver	49	33	359	86	33	588	287	-	-	800	-	-
Stage 1	102	200	-	268	333	-	-	-	-	-	-	-
Stage 2	472	330	-	391	198	-	-	-	-	-	-	-
Platoon blocked, %								-	-	-	-	-
Mov Cap-1 Maneuver	31	22	359	54	22	588	287	-	-	800	-	-
Mov Cap-2 Maneuver	31	22	-	54	22	-	-	-	-	-	-	-
Stage 1	77	180	-	202	251	-	-	-	-	-	-	-
Stage 2	308	248	-	307	178	-	-	-	-	-	-	-

Approach	EB		WB		NB		SB	
HCM Control Delay, s	25.4		33.5		1.7		0.6	
HCM LOS	D		D					

Minor Lane/Major Mvmt	NBL	NBT	NBR	EBLn1	EBLn2	WBLn1	WBLn2	SBL	SBT	SBR
Capacity (veh/h)	287	-	-	31	250	54	412	800	-	-
HCM Lane V/C Ratio	0.248	-	-	0.041	0.179	0.356	0.187	0.099	-	-
HCM Control Delay (s)	21.6	-	-	126.1	22.5	104.8	15.7	10	-	-
HCM Lane LOS	C	-	-	F	C	F	C	A	-	-
HCM 95th %tile Q(veh)	1	-	-	0.1	0.6	1.3	0.7	0.3	-	-

Lanes, Volumes, Timings
1: Walden Street & 104th Avenue

Lane Group	EBL	EBT	EBR	WBL	WBT	WBR	NBL	NBT	NBR	SBL	SBT	SBR
Lane Configurations												
Traffic Volume (vph)	24	528	128	20	732	89	173	39	37	56	14	19
Future Volume (vph)	24	528	128	20	732	89	173	39	37	56	14	19
Ideal Flow (vphpl)	1900	1900	1900	1900	1900	1900	1900	1900	1900	1900	1900	1900
Storage Length (ft)	400		250	250		0	220		220	210		130
Storage Lanes	1		1	1		1	1		1	1		1
Taper Length (ft)	25			25			25			25		
Lane Util. Factor	1.00	0.95	1.00	1.00	0.95	1.00	1.00	1.00	1.00	1.00	1.00	1.00
Frt			0.850			0.850			0.850			0.850
Flt Protected	0.950			0.950			0.950			0.950		
Satd. Flow (prot)	1770	3539	1583	1770	3539	1583	1770	1863	1583	1770	1863	1583
Flt Permitted	0.300			0.412			0.358			0.724		
Satd. Flow (perm)	559	3539	1583	767	3539	1583	667	1863	1583	1349	1863	1583
Right Turn on Red			Yes			Yes			Yes			Yes
Satd. Flow (RTOR)			218			218			227			168
Link Speed (mph)		45			45			30				30
Link Distance (ft)		149			767			699				204
Travel Time (s)		2.3			11.6			15.9				4.6
Peak Hour Factor	0.78	0.92	0.84	0.78	0.92	0.80	0.84	0.78	0.78	0.78	0.78	0.78
Adj. Flow (vph)	31	574	152	26	796	111	206	50	47	72	18	24
Shared Lane Traffic (%)												
Lane Group Flow (vph)	31	574	152	26	796	111	206	50	47	72	18	24
Enter Blocked Intersection	No	No	No	No	No	No	No	No	No	No	No	No
Lane Alignment	Left	Left	Right	Left	Left	Right	Left	Left	Right	Left	Left	Right
Median Width(ft)		12			12			12				12
Link Offset(ft)		0			0			0				0
Crosswalk Width(ft)		16			16			16				16
Two way Left Turn Lane												
Headway Factor	1.00	1.00	1.00	1.00	1.00	1.00	1.00	1.00	1.00	1.00	1.00	1.00
Turning Speed (mph)	15		9	15		9	15		9	15		9
Number of Detectors	1	2	1	1	2	1	1	2	1	1	2	1
Detector Template	Left	Thru	Right	Left	Thru	Right	Left	Thru	Right	Left	Thru	Right
Leading Detector (ft)	20	100	20	20	100	20	20	100	20	20	100	20
Trailing Detector (ft)	0	0	0	0	0	0	0	0	0	0	0	0
Detector 1 Position(ft)	0	0	0	0	0	0	0	0	0	0	0	0
Detector 1 Size(ft)	20	6	20	20	6	20	20	6	20	20	6	20
Detector 1 Type	Cl+Ex	Cl+Ex	Cl+Ex	Cl+Ex	Cl+Ex	Cl+Ex	Cl+Ex	Cl+Ex	Cl+Ex	Cl+Ex	Cl+Ex	Cl+Ex
Detector 1 Channel												
Detector 1 Extend (s)	0.0	0.0	0.0	0.0	0.0	0.0	0.0	0.0	0.0	0.0	0.0	0.0
Detector 1 Queue (s)	0.0	0.0	0.0	0.0	0.0	0.0	0.0	0.0	0.0	0.0	0.0	0.0
Detector 1 Delay (s)	0.0	0.0	0.0	0.0	0.0	0.0	0.0	0.0	0.0	0.0	0.0	0.0
Detector 2 Position(ft)		94			94			94				94
Detector 2 Size(ft)		6			6			6				6
Detector 2 Type		Cl+Ex			Cl+Ex			Cl+Ex				Cl+Ex
Detector 2 Channel												
Detector 2 Extend (s)		0.0			0.0			0.0				0.0
Turn Type	pm+pt	NA	Perm	pm+pt	NA	Perm	pm+pt	NA	Perm	pm+pt	NA	Perm
Protected Phases	5	2		1	6		3	8		7	4	
Permitted Phases	2		2	6		6	8		8	4		4

Lanes, Volumes, Timings
1: Walden Street & 104th Avenue

Lane Group	EBL	EBT	EBR	WBL	WBT	WBR	NBL	NBT	NBR	SBL	SBT	SBR
Detector Phase	5	2	2	1	6	6	3	8	8	7	4	4
Switch Phase												
Minimum Initial (s)	5.0	10.0	10.0	5.0	10.0	10.0	8.0	10.0	10.0	8.0	10.0	10.0
Minimum Split (s)	12.5	17.5	17.5	12.5	17.5	17.5	14.5	16.5	16.5	14.5	16.5	16.5
Total Split (s)	18.0	57.0	57.0	13.0	52.0	52.0	25.0	17.0	17.0	33.0	25.0	25.0
Total Split (%)	15.0%	47.5%	47.5%	10.8%	43.3%	43.3%	20.8%	14.2%	14.2%	27.5%	20.8%	20.8%
Maximum Green (s)	10.5	49.5	49.5	5.5	44.5	44.5	18.5	10.5	10.5	26.5	18.5	18.5
Yellow Time (s)	5.3	5.3	5.3	5.3	5.3	5.3	3.8	3.8	3.8	3.8	3.8	3.8
All-Red Time (s)	2.2	2.2	2.2	2.2	2.2	2.2	2.7	2.7	2.7	2.7	2.7	2.7
Lost Time Adjust (s)	0.0	0.0	0.0	0.0	0.0	0.0	0.0	0.0	0.0	0.0	0.0	0.0
Total Lost Time (s)	7.5	7.5	7.5	7.5	7.5	7.5	6.5	6.5	6.5	6.5	6.5	6.5
Lead/Lag	Lead	Lag	Lag	Lead	Lag	Lag	Lead	Lag	Lag	Lead	Lag	Lag
Lead-Lag Optimize?	Yes	Yes	Yes	Yes	Yes	Yes	Yes	Yes	Yes	Yes	Yes	Yes
Vehicle Extension (s)	2.0	5.0	5.0	2.0	5.0	5.0	2.0	2.0	2.0	2.0	2.0	2.0
Recall Mode	None	C-Max	C-Max	None	C-Max	C-Max	None	None	None	None	None	None
Act Effect Green (s)	73.9	70.4	70.4	73.6	70.3	70.3	27.7	15.2	15.2	15.0	10.0	10.0
Actuated g/C Ratio	0.62	0.59	0.59	0.61	0.59	0.59	0.23	0.13	0.13	0.12	0.08	0.08
v/c Ratio	0.08	0.28	0.15	0.05	0.38	0.11	0.65	0.21	0.12	0.36	0.12	0.08
Control Delay	10.4	15.3	0.8	4.8	7.6	0.2	48.3	48.0	0.6	41.8	52.9	0.6
Queue Delay	0.0	0.0	0.0	0.0	0.0	0.0	0.0	0.0	0.0	0.0	0.0	0.0
Total Delay	10.4	15.3	0.8	4.8	7.6	0.2	48.3	48.0	0.6	41.8	52.9	0.6
LOS	B	B	A	A	A	A	D	D	A	D	D	A
Approach Delay		12.2			6.6			40.9			34.8	
Approach LOS		B			A			D			C	

Intersection Summary

Area Type: Other
 Cycle Length: 120
 Actuated Cycle Length: 120
 Offset: 0.7 (1%), Referenced to phase 2:EBTL and 6:WBTL, Start of Yellow
 Natural Cycle: 70
 Control Type: Actuated-Coordinated
 Maximum v/c Ratio: 0.65
 Intersection Signal Delay: 15.1 Intersection LOS: B
 Intersection Capacity Utilization 55.2% ICU Level of Service B
 Analysis Period (min) 15

Splits and Phases: 1: Walden Street & 104th Avenue



Queues
1: Walden Street & 104th Avenue



Lane Group	EBL	EBT	EBR	WBL	WBT	WBR	NBL	NBT	NBR	SBL	SBT	SBR
Lane Group Flow (vph)	31	574	152	26	796	111	206	50	47	72	18	24
v/c Ratio	0.08	0.28	0.15	0.05	0.38	0.11	0.65	0.21	0.12	0.36	0.12	0.08
Control Delay	10.4	15.3	0.8	4.8	7.6	0.2	48.3	48.0	0.6	41.8	52.9	0.6
Queue Delay	0.0	0.0	0.0	0.0	0.0	0.0	0.0	0.0	0.0	0.0	0.0	0.0
Total Delay	10.4	15.3	0.8	4.8	7.6	0.2	48.3	48.0	0.6	41.8	52.9	0.6
Queue Length 50th (ft)	9	133	0	3	79	0	132	34	0	42	13	0
Queue Length 95th (ft)	20	184	1	m7	163	m0	183	63	0	68	33	0
Internal Link Dist (ft)		69			687			619			124	
Turn Bay Length (ft)	400		250	250			220		220	210		130
Base Capacity (vph)	463	2076	1018	518	2072	1017	342	237	399	442	287	386
Starvation Cap Reductn	0	0	0	0	0	0	0	0	0	0	0	0
Spillback Cap Reductn	0	0	0	0	0	0	0	0	0	0	0	0
Storage Cap Reductn	0	0	0	0	0	0	0	0	0	0	0	0
Reduced v/c Ratio	0.07	0.28	0.15	0.05	0.38	0.11	0.60	0.21	0.12	0.16	0.06	0.06

Intersection Summary

m Volume for 95th percentile queue is metered by upstream signal.

HCM 6th Signalized Intersection Summary
 1: Walden Street & 104th Avenue

JR Engineering
 09/21/2023



Movement	EBL	EBT	EBR	WBL	WBT	WBR	NBL	NBT	NBR	SBL	SBT	SBR
Lane Configurations	↘	↗	↘	↘	↗	↘	↘	↗	↘	↘	↗	↘
Traffic Volume (veh/h)	24	528	128	20	732	89	173	39	37	56	14	19
Future Volume (veh/h)	24	528	128	20	732	89	173	39	37	56	14	19
Initial Q (Qb), veh	0	0	0	0	0	0	0	0	0	0	0	0
Ped-Bike Adj(A_pbT)	1.00		1.00	1.00		1.00	1.00		1.00	1.00		1.00
Parking Bus, Adj	1.00	1.00	1.00	1.00	1.00	1.00	1.00	1.00	1.00	1.00	1.00	1.00
Work Zone On Approach		No			No			No			No	
Adj Sat Flow, veh/h/ln	1870	1870	1870	1870	1870	1870	1870	1870	1870	1870	1870	1870
Adj Flow Rate, veh/h	31	574	152	26	796	111	206	50	47	72	18	24
Peak Hour Factor	0.78	0.92	0.84	0.78	0.92	0.80	0.84	0.78	0.78	0.78	0.78	0.78
Percent Heavy Veh, %	2	2	2	2	2	2	2	2	2	2	2	2
Cap, veh/h	383	1918	855	481	1908	851	377	266	225	281	156	132
Arrive On Green	0.03	0.54	0.54	0.02	0.54	0.54	0.12	0.14	0.14	0.06	0.08	0.08
Sat Flow, veh/h	1781	3554	1585	1781	3554	1585	1781	1870	1585	1781	1870	1585
Grp Volume(v), veh/h	31	574	152	26	796	111	206	50	47	72	18	24
Grp Sat Flow(s),veh/h/ln	1781	1777	1585	1781	1777	1585	1781	1870	1585	1781	1870	1585
Q Serve(g_s), s	0.9	10.6	5.9	0.8	16.0	4.2	12.2	2.8	3.1	4.3	1.1	1.7
Cycle Q Clear(g_c), s	0.9	10.6	5.9	0.8	16.0	4.2	12.2	2.8	3.1	4.3	1.1	1.7
Prop In Lane	1.00		1.00	1.00		1.00	1.00		1.00	1.00		1.00
Lane Grp Cap(c), veh/h	383	1918	855	481	1908	851	377	266	225	281	156	132
V/C Ratio(X)	0.08	0.30	0.18	0.05	0.42	0.13	0.55	0.19	0.21	0.26	0.12	0.18
Avail Cap(c_a), veh/h	491	1918	855	520	1908	851	438	266	225	566	288	244
HCM Platoon Ratio	1.00	1.00	1.00	1.00	1.00	1.00	1.00	1.00	1.00	1.00	1.00	1.00
Upstream Filter(I)	1.00	1.00	1.00	1.00	1.00	1.00	1.00	1.00	1.00	1.00	1.00	1.00
Uniform Delay (d), s/veh	12.7	15.2	14.1	12.2	16.6	13.8	41.4	45.4	45.5	45.8	50.9	51.2
Incr Delay (d2), s/veh	0.0	0.4	0.5	0.0	0.7	0.3	0.5	0.1	0.2	0.2	0.1	0.2
Initial Q Delay(d3),s/veh	0.0	0.0	0.0	0.0	0.0	0.0	0.0	0.0	0.0	0.0	0.0	0.0
%ile BackOfQ(50%),veh/ln	0.3	4.1	2.2	0.3	6.3	1.6	5.4	1.3	1.3	1.9	0.5	0.7
Unsig. Movement Delay, s/veh												
LnGrp Delay(d),s/veh	12.8	15.6	14.5	12.2	17.2	14.1	41.8	45.5	45.7	46.0	51.0	51.4
LnGrp LOS	B	B	B	B	B	B	D	D	D	D	D	D
Approach Vol, veh/h		757			933			303			114	
Approach Delay, s/veh		15.2			16.7			43.0			47.9	
Approach LOS		B			B			D			D	
Timer - Assigned Phs	1	2	3	4	5	6	7	8				
Phs Duration (G+Y+Rc), s	10.4	72.3	20.9	16.5	10.7	71.9	13.8	23.6				
Change Period (Y+Rc), s	* 7.5	* 7.5	6.5	6.5	* 7.5	* 7.5	6.5	6.5				
Max Green Setting (Gmax), s	* 5.5	* 50	18.5	18.5	* 11	* 45	26.5	10.5				
Max Q Clear Time (g_c+I1), s	2.8	12.6	14.2	3.7	2.9	18.0	6.3	5.1				
Green Ext Time (p_c), s	0.0	9.2	0.1	0.0	0.0	11.0	0.1	0.1				

Intersection Summary

HCM 6th Ctrl Delay	21.7
HCM 6th LOS	C

Notes

* HCM 6th computational engine requires equal clearance times for the phases crossing the barrier.

Lanes, Volumes, Timings
2: Yampa Street & 104th Avenue



Lane Group	EBT	EBR	WBL	WBT	NBL	NBR
Lane Configurations	↑↑↑	↑	↓	↑↑↑		↓
Traffic Volume (vph)	643	12	16	496	0	12
Future Volume (vph)	643	12	16	496	0	12
Ideal Flow (vphpl)	1900	1900	1900	1900	1900	1900
Storage Length (ft)		50	50		0	0
Storage Lanes		1	1		0	1
Taper Length (ft)			25		25	
Lane Util. Factor	0.91	1.00	1.00	0.91	1.00	1.00
Frt		0.850				0.865
Flt Protected			0.950			
Satd. Flow (prot)	5085	1583	1770	5085	0	1611
Flt Permitted			0.950			
Satd. Flow (perm)	5085	1583	1770	5085	0	1611
Link Speed (mph)	30			30	30	
Link Distance (ft)	767			1110	440	
Travel Time (s)	17.4			25.2	10.0	
Peak Hour Factor	0.92	0.78	0.78	0.88	0.78	0.78
Adj. Flow (vph)	699	15	21	564	0	15
Shared Lane Traffic (%)						
Lane Group Flow (vph)	699	15	21	564	0	15
Enter Blocked Intersection	No	No	No	No	No	No
Lane Alignment	Left	Right	Left	Left	Left	Right
Median Width(ft)	12			12	0	
Link Offset(ft)	0			0	0	
Crosswalk Width(ft)	16			16	16	
Two way Left Turn Lane						
Headway Factor	1.00	1.00	1.00	1.00	1.00	1.00
Turning Speed (mph)		60	60		60	60
Sign Control	Free			Free	Stop	

Intersection Summary

Area Type:	Other
Control Type:	Unsignalized
Intersection Capacity Utilization	22.4%
ICU Level of Service	A
Analysis Period (min)	15

Intersection						
Int Delay, s/veh	0.3					
Movement	EBT	EBR	WBL	WBT	NBL	NBR
Lane Configurations	↑↑↑	↑	↑	↑↑↑		↑
Traffic Vol, veh/h	643	12	16	496	0	12
Future Vol, veh/h	643	12	16	496	0	12
Conflicting Peds, #/hr	0	0	0	0	0	0
Sign Control	Free	Free	Free	Free	Stop	Stop
RT Channelized	-	None	-	None	-	None
Storage Length	-	50	50	-	-	0
Veh in Median Storage, #	0	-	-	0	0	-
Grade, %	0	-	-	0	0	-
Peak Hour Factor	92	78	78	88	78	78
Heavy Vehicles, %	2	2	2	2	2	2
Mvmt Flow	699	15	21	564	0	15

Major/Minor	Major1	Major2	Minor1	Minor2	Minor3
Conflicting Flow All	0	0	714	0	- 350
Stage 1	-	-	-	-	-
Stage 2	-	-	-	-	-
Critical Hdwy	-	-	5.34	-	- 7.14
Critical Hdwy Stg 1	-	-	-	-	-
Critical Hdwy Stg 2	-	-	-	-	-
Follow-up Hdwy	-	-	3.12	-	- 3.92
Pot Cap-1 Maneuver	-	-	537	-	0 552
Stage 1	-	-	-	-	0 -
Stage 2	-	-	-	-	0 -
Platoon blocked, %	-	-	-	-	-
Mov Cap-1 Maneuver	-	-	537	-	- 552
Mov Cap-2 Maneuver	-	-	-	-	-
Stage 1	-	-	-	-	-
Stage 2	-	-	-	-	-

Approach	EB	WB	NB
HCM Control Delay, s	0	0.4	11.7
HCM LOS			B

Minor Lane/Major Mvmt	NBLn1	EBT	EBR	WBL	WBT
Capacity (veh/h)	552	-	-	537	-
HCM Lane V/C Ratio	0.028	-	-	0.038	-
HCM Control Delay (s)	11.7	-	-	12	-
HCM Lane LOS	B	-	-	B	-
HCM 95th %tile Q(veh)	0.1	-	-	0.1	-

Lanes, Volumes, Timings
3: Tower Road & 104th Avenue

Lane Group	EBL	EBT	EBR	WBL	WBT	WBR	NBL	NBT	NBR	SBL	SBT	SBR
Lane Configurations												
Traffic Volume (vph)	103	144	394	22	194	17	595	821	28	10	480	80
Future Volume (vph)	103	144	394	22	194	17	595	821	28	10	480	80
Ideal Flow (vphpl)	1900	1900	1900	1900	1900	1900	1900	1900	1900	1900	1900	1900
Storage Length (ft)	420		0	475		300	160		0	250		0
Storage Lanes	1		1	1		1	2		1	1		1
Taper Length (ft)	25			25			25			25		
Lane Util. Factor	1.00	0.91	1.00	1.00	0.91	1.00	0.97	0.95	1.00	1.00	0.95	1.00
Frt			0.850			0.850			0.850			0.850
Flt Protected	0.950			0.950			0.950			0.950		
Satd. Flow (prot)	1770	5085	1583	1770	5085	1583	3433	3539	1583	1770	3539	1583
Flt Permitted	0.477			0.639			0.950			0.950		
Satd. Flow (perm)	889	5085	1583	1190	5085	1583	3433	3539	1583	1770	3539	1583
Right Turn on Red			Yes			Yes			Yes			Yes
Satd. Flow (RTOR)			448			264			182			256
Link Speed (mph)		35			35			30				30
Link Distance (ft)		1110			840			620				1000
Travel Time (s)		21.6			16.4			14.1				22.7
Peak Hour Factor	0.83	0.84	0.88	0.78	0.87	0.78	0.92	0.92	0.78	0.78	0.88	0.80
Adj. Flow (vph)	124	171	448	28	223	22	647	892	36	13	545	100
Shared Lane Traffic (%)												
Lane Group Flow (vph)	124	171	448	28	223	22	647	892	36	13	545	100
Enter Blocked Intersection	No	No	No	No	No	No	No	No	No	No	No	No
Lane Alignment	Left	Left	Right	Left	Left	Right	Left	Left	Right	Left	Left	Right
Median Width(ft)		12			12			24				24
Link Offset(ft)		0			0			0				0
Crosswalk Width(ft)		16			16			16				16
Two way Left Turn Lane												
Headway Factor	1.00	1.00	1.00	1.00	1.00	1.00	1.00	1.00	1.00	1.00	1.00	1.00
Turning Speed (mph)	15		9	15		9	15		9	15		9
Number of Detectors	1	1	1	1	1	1	1	1	1	1	1	1
Detector Template	Left	Thru	Right	Left	Thru	Right	Left	Thru	Right	Left	Thru	Right
Leading Detector (ft)	40	40	40	40	40	40	40	40	40	40	40	40
Trailing Detector (ft)	0	0	0	0	0	0	0	0	0	0	0	0
Detector 1 Position(ft)	0	0	0	0	0	0	0	0	0	0	0	0
Detector 1 Size(ft)	40	40	40	40	40	40	40	40	40	40	40	40
Detector 1 Type	Cl+Ex	Cl+Ex	Cl+Ex	Cl+Ex	Cl+Ex	Cl+Ex	Cl+Ex	Cl+Ex	Cl+Ex	Cl+Ex	Cl+Ex	Cl+Ex
Detector 1 Channel												
Detector 1 Extend (s)	0.0	0.0	0.0	0.0	0.0	0.0	0.0	0.0	0.0	0.0	0.0	0.0
Detector 1 Queue (s)	0.0	0.0	0.0	0.0	0.0	0.0	0.0	0.0	0.0	0.0	0.0	0.0
Detector 1 Delay (s)	0.0	0.0	0.0	0.0	0.0	0.0	0.0	0.0	0.0	0.0	0.0	0.0
Turn Type	pm+pt	NA	Perm	pm+pt	NA	Perm	Prot	NA	Perm	Prot	NA	Perm
Protected Phases	7	4		3	8		5	2		1	6	
Permitted Phases	4		4	8		8			2			6
Detector Phase	7	4	4	3	8	8	5	2	2	1	6	6
Switch Phase												
Minimum Initial (s)	8.0	10.0	10.0	8.0	10.0	10.0	8.0	10.0	10.0	8.0	10.0	10.0
Minimum Split (s)	15.4	32.0	32.0	15.4	32.0	32.0	16.2	40.2	40.2	16.2	31.0	31.0
Total Split (s)	16.0	32.0	32.0	16.0	32.0	32.0	41.0	55.0	55.0	17.0	31.0	31.0

Lanes, Volumes, Timings
3: Tower Road & 104th Avenue



Lane Group	EBL	EBT	EBR	WBL	WBT	WBR	NBL	NBT	NBR	SBL	SBT	SBR
Total Split (%)	13.3%	26.7%	26.7%	13.3%	26.7%	26.7%	34.2%	45.8%	45.8%	14.2%	25.8%	25.8%
Maximum Green (s)	8.6	24.6	24.6	8.6	24.6	24.6	32.8	46.8	46.8	8.8	22.8	22.8
Yellow Time (s)	5.0	5.0	5.0	5.0	5.0	5.0	5.1	5.1	5.1	5.1	5.1	5.1
All-Red Time (s)	2.4	2.4	2.4	2.4	2.4	2.4	3.1	3.1	3.1	3.1	3.1	3.1
Lost Time Adjust (s)	0.0	0.0	0.0	0.0	0.0	0.0	0.0	0.0	0.0	0.0	0.0	0.0
Total Lost Time (s)	7.4	7.4	7.4	7.4	7.4	7.4	8.2	8.2	8.2	8.2	8.2	8.2
Lead/Lag	Lead	Lag	Lag	Lead	Lag	Lag	Lead	Lag	Lag	Lead	Lag	Lag
Lead-Lag Optimize?	Yes	Yes	Yes	Yes	Yes	Yes	Yes	Yes	Yes	Yes	Yes	Yes
Vehicle Extension (s)	2.0	2.0	2.0	2.0	2.0	2.0	2.0	5.0	5.0	2.0	5.0	5.0
Recall Mode	None	None	None	None	None	None	None	C-Min	C-Min	None	C-Min	C-Min
Act Effct Green (s)	24.2	19.1	19.1	20.0	12.0	12.0	26.9	69.6	69.6	8.0	41.0	41.0
Actuated g/C Ratio	0.20	0.16	0.16	0.17	0.10	0.10	0.22	0.58	0.58	0.07	0.34	0.34
v/c Ratio	0.51	0.21	0.71	0.12	0.44	0.06	0.84	0.43	0.04	0.11	0.45	0.14
Control Delay	37.9	38.9	24.0	35.6	52.9	0.3	54.9	16.9	0.1	55.0	33.8	0.4
Queue Delay	0.0	0.0	0.0	0.0	0.0	0.0	0.0	0.0	0.0	0.0	0.0	0.0
Total Delay	37.9	38.9	24.0	35.6	52.9	0.3	54.9	16.9	0.1	55.0	33.8	0.4
LOS	D	D	C	D	D	A	D	B	A	D	C	A
Approach Delay		29.8			46.9			32.1			29.2	
Approach LOS		C			D			C			C	

Intersection Summary

Area Type: Other
 Cycle Length: 120
 Actuated Cycle Length: 120
 Offset: 0 (0%), Referenced to phase 2:NBT and 6:SBT, Start of Yellow, Master Intersection
 Natural Cycle: 105
 Control Type: Actuated-Coordinated
 Maximum v/c Ratio: 0.84
 Intersection Signal Delay: 32.2
 Intersection LOS: C
 Intersection Capacity Utilization 71.2%
 ICU Level of Service C
 Analysis Period (min) 15

Splits and Phases: 3: Tower Road & 104th Avenue



Queues
3: Tower Road & 104th Avenue



Lane Group	EBL	EBT	EBR	WBL	WBT	WBR	NBL	NBT	NBR	SBL	SBT	SBR
Lane Group Flow (vph)	124	171	448	28	223	22	647	892	36	13	545	100
v/c Ratio	0.51	0.21	0.71	0.12	0.44	0.06	0.84	0.43	0.04	0.11	0.45	0.14
Control Delay	37.9	38.9	24.0	35.6	52.9	0.3	54.9	16.9	0.1	55.0	33.8	0.4
Queue Delay	0.0	0.0	0.0	0.0	0.0	0.0	0.0	0.0	0.0	0.0	0.0	0.0
Total Delay	37.9	38.9	24.0	35.6	52.9	0.3	54.9	16.9	0.1	55.0	33.8	0.4
Queue Length 50th (ft)	84	47	160	17	61	0	247	155	0	10	166	0
Queue Length 95th (ft)	123	64	261	33	79	0	297	332	0	26	257	0
Internal Link Dist (ft)		1030			760			540			920	
Turn Bay Length (ft)	420			475		300	160			250		
Base Capacity (vph)	245	1077	688	246	1042	534	938	2053	995	129	1209	709
Starvation Cap Reductn	0	0	0	0	0	0	0	0	0	0	0	0
Spillback Cap Reductn	0	0	0	0	0	0	0	0	0	0	0	0
Storage Cap Reductn	0	0	0	0	0	0	0	0	0	0	0	0
Reduced v/c Ratio	0.51	0.16	0.65	0.11	0.21	0.04	0.69	0.43	0.04	0.10	0.45	0.14

Intersection Summary

HCM 6th Signalized Intersection Summary
3: Tower Road & 104th Avenue

JR Engineering
09/21/2023



Movement	EBL	EBT	EBR	WBL	WBT	WBR	NBL	NBT	NBR	SBL	SBT	SBR
Lane Configurations	↘	↑↑↑	↗	↘	↑↑↑	↗	↘↗	↑↑	↗	↘	↑↑	↗
Traffic Volume (veh/h)	103	144	394	22	194	17	595	821	28	10	480	80
Future Volume (veh/h)	103	144	394	22	194	17	595	821	28	10	480	80
Initial Q (Qb), veh	0	0	0	0	0	0	0	0	0	0	0	0
Ped-Bike Adj(A_pbT)	1.00		1.00	1.00		1.00	1.00		1.00	1.00		1.00
Parking Bus, Adj	1.00	1.00	1.00	1.00	1.00	1.00	1.00	1.00	1.00	1.00	1.00	1.00
Work Zone On Approach		No			No			No			No	
Adj Sat Flow, veh/h/ln	1870	1870	1870	1870	1870	1870	1870	1870	1870	1870	1870	1870
Adj Flow Rate, veh/h	124	171	0	28	223	0	647	892	0	13	545	0
Peak Hour Factor	0.83	0.84	0.88	0.78	0.87	0.78	0.92	0.92	0.78	0.78	0.88	0.80
Percent Heavy Veh, %	2	2	2	2	2	2	2	2	2	2	2	2
Cap, veh/h	236	585		232	426		724	1996		42	1334	
Arrive On Green	0.02	0.04	0.00	0.04	0.08	0.00	0.21	0.56	0.00	0.02	0.38	0.00
Sat Flow, veh/h	1781	5106	1585	1781	5106	1585	3456	3554	1585	1781	3554	1585
Grp Volume(v), veh/h	124	171	0	28	223	0	647	892	0	13	545	0
Grp Sat Flow(s),veh/h/ln	1781	1702	1585	1781	1702	1585	1728	1777	1585	1781	1777	1585
Q Serve(g_s), s	7.6	3.9	0.0	1.7	5.0	0.0	21.8	17.6	0.0	0.9	13.6	0.0
Cycle Q Clear(g_c), s	7.6	3.9	0.0	1.7	5.0	0.0	21.8	17.6	0.0	0.9	13.6	0.0
Prop In Lane	1.00		1.00	1.00		1.00	1.00		1.00	1.00		1.00
Lane Grp Cap(c), veh/h	236	585		232	426		724	1996		42	1334	
V/C Ratio(X)	0.53	0.29		0.12	0.52		0.89	0.45		0.31	0.41	
Avail Cap(c_a), veh/h	236	1047		287	1047		945	1996		131	1334	
HCM Platoon Ratio	0.33	0.33	0.33	1.00	1.00	1.00	1.00	1.00	1.00	1.00	1.00	1.00
Upstream Filter(l)	1.00	1.00	0.00	1.00	1.00	0.00	1.00	1.00	0.00	1.00	1.00	0.00
Uniform Delay (d), s/veh	48.6	53.0	0.0	46.8	52.7	0.0	46.1	15.4	0.0	57.6	27.6	0.0
Incr Delay (d2), s/veh	1.1	0.1	0.0	0.1	0.4	0.0	7.6	0.7	0.0	1.6	0.9	0.0
Initial Q Delay(d3),s/veh	0.0	0.0	0.0	0.0	0.0	0.0	0.0	0.0	0.0	0.0	0.0	0.0
%ile BackOfQ(50%),veh/ln	3.6	1.7	0.0	0.7	2.1	0.0	10.1	7.2	0.0	0.4	5.9	0.0
Unsig. Movement Delay, s/veh												
LnGrp Delay(d),s/veh	49.6	53.1	0.0	46.9	53.1	0.0	53.7	16.1	0.0	59.2	28.6	0.0
LnGrp LOS	D	D		D	D		D	B		E	C	
Approach Vol, veh/h		295			251			1539			558	
Approach Delay, s/veh		51.6			52.4			31.9			29.3	
Approach LOS		D			D			C			C	
Timer - Assigned Phs	1	2	3	4	5	6	7	8				
Phs Duration (G+Y+Rc), s	11.0	75.6	12.3	21.1	33.4	53.2	16.0	17.4				
Change Period (Y+Rc), s	8.2	8.2	7.4	7.4	8.2	8.2	7.4	7.4				
Max Green Setting (Gmax), s	8.8	46.8	8.6	24.6	32.8	22.8	8.6	24.6				
Max Q Clear Time (g_c+I1), s	2.9	19.6	3.7	5.9	23.8	15.6	9.6	7.0				
Green Ext Time (p_c), s	0.0	9.4	0.0	0.3	1.3	2.6	0.0	0.5				

Intersection Summary

HCM 6th Ctrl Delay	35.5
HCM 6th LOS	D

Notes

User approved pedestrian interval to be less than phase max green.
Unsignalized Delay for [NBR, EBR, WBR, SBR] is excluded from calculations of the approach delay and intersection delay.

Lanes, Volumes, Timings
4: Tower Road & Private Access



Lane Group	EBL	EBR	NBL	NBT	SBT	SBR
Lane Configurations						
Traffic Volume (vph)	0	0	0	0	0	0
Future Volume (vph)	0	0	0	0	0	0
Ideal Flow (vphpl)	1900	1900	1900	1900	1900	1900
Lane Util. Factor	1.00	1.00	1.00	0.95	0.91	0.91
Fr						
Flt Protected						
Satd. Flow (prot)	0	1863	0	3539	5085	0
Flt Permitted						
Satd. Flow (perm)	0	1863	0	3539	5085	0
Link Speed (mph)	30			50	30	
Link Distance (ft)	345			530	620	
Travel Time (s)	7.8			7.2	14.1	
Peak Hour Factor	0.78	0.78	0.78	0.78	0.78	0.78
Adj. Flow (vph)	0	0	0	0	0	0
Shared Lane Traffic (%)						
Lane Group Flow (vph)	0	0	0	0	0	0
Enter Blocked Intersection	No	No	No	No	No	No
Lane Alignment	Left	Right	Left	Left	Left	Right
Median Width(ft)	0			24	24	
Link Offset(ft)	0			0	0	
Crosswalk Width(ft)	16			16	16	
Two way Left Turn Lane						
Headway Factor	1.00	1.00	1.00	1.00	1.00	1.00
Turning Speed (mph)	15	9	15			9
Sign Control	Stop			Free	Free	
Intersection Summary						
Area Type:	Other					
Control Type:	Unsignalized					
Intersection Capacity Utilization	0.0%			ICU Level of Service A		
Analysis Period (min)	15					

Intersection						
Int Delay, s/veh	0					
Movement	EBL	EBR	NBL	NBT	SBT	SBR
Lane Configurations		↗		↑↑	↑↑↑	
Traffic Vol, veh/h	0	0	0	0	0	0
Future Vol, veh/h	0	0	0	0	0	0
Conflicting Peds, #/hr	0	0	0	0	0	0
Sign Control	Stop	Stop	Free	Free	Free	Free
RT Channelized	-	None	-	None	-	None
Storage Length	-	0	-	-	-	-
Veh in Median Storage, #	0	-	-	0	0	-
Grade, %	0	-	-	0	0	-
Peak Hour Factor	78	78	78	78	78	78
Heavy Vehicles, %	2	2	2	2	2	2
Mvmt Flow	0	0	0	0	0	0























Major/Minor	Minor2	Major1	Major2		
Conflicting Flow All	-	1	-	0	-
Stage 1	-	-	-	-	-
Stage 2	-	-	-	-	-
Critical Hdwy	-	7.14	-	-	-
Critical Hdwy Stg 1	-	-	-	-	-
Critical Hdwy Stg 2	-	-	-	-	-
Follow-up Hdwy	-	3.92	-	-	-
Pot Cap-1 Maneuver	0	917	0	-	-
Stage 1	0	-	0	-	-
Stage 2	0	-	0	-	-
Platoon blocked, %				-	-
Mov Cap-1 Maneuver	-	917	-	-	-
Mov Cap-2 Maneuver	-	-	-	-	-
Stage 1	-	-	-	-	-
Stage 2	-	-	-	-	-

Approach	EB	NB	SB
HCM Control Delay, s	0	0	0
HCM LOS	A		

Minor Lane/Major Mvmt	NBT	EBLn1	SBT	SBR
Capacity (veh/h)	-	-	-	-
HCM Lane V/C Ratio	-	-	-	-
HCM Control Delay (s)	-	0	-	-
HCM Lane LOS	-	A	-	-
HCM 95th %tile Q(veh)	-	-	-	-

Lanes, Volumes, Timings
5: 103rd Avenue & Tower Road

JR Engineering
09/21/2023

												
Lane Group	EBL	EBT	EBR	WBL	WBT	WBR	NBL	NBT	NBR	SBL	SBT	SBR
Lane Configurations												
Traffic Volume (vph)	7	1	34	16	1	65	112	1319	13	69	930	8
Future Volume (vph)	7	1	34	16	1	65	112	1319	13	69	930	8
Ideal Flow (vphpl)	1900	1900	1900	1900	1900	1900	1900	1900	1900	1900	1900	1900
Storage Length (ft)	45		0	100		0	440		185	130		0
Storage Lanes	1		0	1		0	1		0	1		0
Taper Length (ft)	25			25			25			25		
Lane Util. Factor	1.00	1.00	1.00	1.00	1.00	1.00	1.00	0.95	0.95	1.00	0.91	0.91
Frt		0.853			0.852			0.998			0.999	
Flt Protected	0.950			0.950			0.950			0.950		
Satd. Flow (prot)	1770	1589	0	1770	1587	0	1770	3532	0	1770	5080	0
Flt Permitted	0.950			0.950			0.950			0.950		
Satd. Flow (perm)	1770	1589	0	1770	1587	0	1770	3532	0	1770	5080	0
Link Speed (mph)		30			30			50			30	
Link Distance (ft)		875			708			356			530	
Travel Time (s)		19.9			16.1			4.9			12.0	
Peak Hour Factor	0.78	0.78	0.78	0.78	0.78	0.79	0.84	0.93	0.78	0.79	0.92	0.78
Adj. Flow (vph)	9	1	44	21	1	82	133	1418	17	87	1011	10
Shared Lane Traffic (%)												
Lane Group Flow (vph)	9	45	0	21	83	0	133	1435	0	87	1021	0
Enter Blocked Intersection	No	No	No	No	No	No	No	No	No	No	No	No
Lane Alignment	Left	Left	Right	Left	Left	Right	Left	Left	Right	Left	Left	Right
Median Width(ft)		12			12			12			12	
Link Offset(ft)		0			0			0			0	
Crosswalk Width(ft)		16			16			16			16	
Two way Left Turn Lane												
Headway Factor	1.00	1.00	1.00	1.00	1.00	1.00	1.00	1.00	1.00	1.00	1.00	1.00
Turning Speed (mph)	60		60	60		60	60		60	60		60
Sign Control		Stop			Stop			Free			Free	

Intersection Summary

Area Type:	Other
Control Type:	Unsignalized
Intersection Capacity Utilization	58.2%
ICU Level of Service	B
Analysis Period (min)	15

Intersection												
Int Delay, s/veh	8.8											
Movement	EBL	EBT	EBR	WBL	WBT	WBR	NBL	NBT	NBR	SBL	SBT	SBR
Lane Configurations	↵	↵		↵	↵		↵	↵↵		↵	↵↵↵	
Traffic Vol, veh/h	7	1	34	16	1	65	112	1319	13	69	930	8
Future Vol, veh/h	7	1	34	16	1	65	112	1319	13	69	930	8
Conflicting Peds, #/hr	0	0	0	0	0	0	0	0	0	0	0	0
Sign Control	Stop	Stop	Stop	Stop	Stop	Stop	Free	Free	Free	Free	Free	Free
RT Channelized	-	-	None	-	-	None	-	-	None	-	-	None
Storage Length	45	-	-	100	-	-	440	-	-	130	-	-
Veh in Median Storage, #	-	0	-	-	0	-	-	0	-	-	0	-
Grade, %	-	0	-	-	0	-	-	0	-	-	0	-
Peak Hour Factor	78	78	78	78	78	79	84	93	78	79	92	78
Heavy Vehicles, %	2	2	2	2	2	2	2	2	2	2	2	2
Mvmt Flow	9	1	44	21	1	82	133	1418	17	87	1011	10

Major/Minor	Minor2		Minor1		Major1		Major2					
Conflicting Flow All	2166	2891	511	2272	2888	718	1021	0	0	1435	0	0
Stage 1	1190	1190	-	1693	1693	-	-	-	-	-	-	-
Stage 2	976	1701	-	579	1195	-	-	-	-	-	-	-
Critical Hdwy	6.99	6.54	7.14	6.99	6.54	6.94	5.34	-	-	4.14	-	-
Critical Hdwy Stg 1	7.34	5.54	-	6.54	5.54	-	-	-	-	-	-	-
Critical Hdwy Stg 2	6.54	5.54	-	6.74	5.54	-	-	-	-	-	-	-
Follow-up Hdwy	3.67	4.02	3.92	3.67	4.02	3.32	3.12	-	-	2.22	-	-
Pot Cap-1 Maneuver	36	16	435	31	16	371	382	-	-	469	-	-
Stage 1	150	259	-	95	147	-	-	-	-	-	-	-
Stage 2	263	146	-	439	258	-	-	-	-	-	-	-
Platoon blocked, %								-	-	-	-	-
Mov Cap-1 Maneuver	16	8	435	~ 16	8	371	382	-	-	469	-	-
Mov Cap-2 Maneuver	16	8	-	~ 16	8	-	-	-	-	-	-	-
Stage 1	98	211	-	62	96	-	-	-	-	-	-	-
Stage 2	132	95	-	320	210	-	-	-	-	-	-	-

Approach	EB	WB	NB	SB
HCM Control Delay, s	92.5	155	1.6	1.1
HCM LOS	F	F		

Minor Lane/Major Mvmt	NBL	NBT	NBR	EBLn1	EBLn2	WBLn1	WBLn2	SBL	SBT	SBR
Capacity (veh/h)	382	-	-	16	172	16	219	469	-	-
HCM Lane V/C Ratio	0.349	-	-	0.561	0.261	1.282	0.382	0.186	-	-
HCM Control Delay (s)	19.4	-	-	\$ 389.2	33.2	\$ 659.3	31.2	14.4	-	-
HCM Lane LOS	C	-	-	F	D	F	D	B	-	-
HCM 95th %tile Q(veh)	1.5	-	-	1.4	1	3.1	1.7	0.7	-	-

Notes
 ~: Volume exceeds capacity \$: Delay exceeds 300s +: Computation Not Defined *: All major volume in platoon

Lanes, Volumes, Timings
1: Walden Street & 104th Avenue

JR Engineering
10/03/2023

Lane Group	EBL	EBT	EBR	WBL	WBT	WBR	NBL	NBT	NBR	SBL	SBT	SBR
Lane Configurations												
Traffic Volume (vph)	80	794	82	17	363	96	154	36	68	178	34	86
Future Volume (vph)	80	794	82	17	363	96	154	36	68	178	34	86
Ideal Flow (vphpl)	1900	1900	1900	1900	1900	1900	1900	1900	1900	1900	1900	1900
Storage Length (ft)	400		250	250		0	220		220	210		130
Storage Lanes	1		1	1		1	1		1	1		1
Taper Length (ft)	25			25			25			25		
Lane Util. Factor	1.00	0.95	1.00	1.00	0.95	1.00	1.00	1.00	1.00	1.00	1.00	1.00
Frt			0.850			0.850			0.850			0.850
Flt Protected	0.950			0.950			0.950			0.950		
Satd. Flow (prot)	1770	3539	1583	1770	3539	1583	1770	1863	1583	1770	1863	1583
Flt Permitted	0.459			0.279			0.728			0.403		
Satd. Flow (perm)	855	3539	1583	520	3539	1583	1356	1863	1583	751	1863	1583
Right Turn on Red			Yes			Yes			Yes			Yes
Satd. Flow (RTOR)			218			218			227			168
Link Speed (mph)		45			45			30				30
Link Distance (ft)		149			767			699				204
Travel Time (s)		2.3			11.6			15.9				4.6
Peak Hour Factor	0.80	0.92	0.80	0.78	0.88	0.80	0.84	0.78	0.79	0.84	0.78	0.79
Adj. Flow (vph)	100	863	103	22	413	120	183	46	86	212	44	109
Shared Lane Traffic (%)												
Lane Group Flow (vph)	100	863	103	22	413	120	183	46	86	212	44	109
Enter Blocked Intersection	No	No	No	No	No	No	No	No	No	No	No	No
Lane Alignment	Left	Left	Right	Left	Left	Right	Left	Left	Right	Left	Left	Right
Median Width(ft)		12			12			12				12
Link Offset(ft)		0			0			0				0
Crosswalk Width(ft)		16			16			16				16
Two way Left Turn Lane												
Headway Factor	1.00	1.00	1.00	1.00	1.00	1.00	1.00	1.00	1.00	1.00	1.00	1.00
Turning Speed (mph)	15		9	15		9	15		9	15		9
Number of Detectors	1	2	1	1	2	1	1	2	1	1	2	1
Detector Template	Left	Thru	Right	Left	Thru	Right	Left	Thru	Right	Left	Thru	Right
Leading Detector (ft)	20	100	20	20	100	20	20	100	20	20	100	20
Trailing Detector (ft)	0	0	0	0	0	0	0	0	0	0	0	0
Detector 1 Position(ft)	0	0	0	0	0	0	0	0	0	0	0	0
Detector 1 Size(ft)	20	6	20	20	6	20	20	6	20	20	6	20
Detector 1 Type	Cl+Ex	Cl+Ex	Cl+Ex	Cl+Ex	Cl+Ex	Cl+Ex	Cl+Ex	Cl+Ex	Cl+Ex	Cl+Ex	Cl+Ex	Cl+Ex
Detector 1 Channel												
Detector 1 Extend (s)	0.0	0.0	0.0	0.0	0.0	0.0	0.0	0.0	0.0	0.0	0.0	0.0
Detector 1 Queue (s)	0.0	0.0	0.0	0.0	0.0	0.0	0.0	0.0	0.0	0.0	0.0	0.0
Detector 1 Delay (s)	0.0	0.0	0.0	0.0	0.0	0.0	0.0	0.0	0.0	0.0	0.0	0.0
Detector 2 Position(ft)		94			94			94				94
Detector 2 Size(ft)		6			6			6				6
Detector 2 Type		Cl+Ex			Cl+Ex			Cl+Ex				Cl+Ex
Detector 2 Channel												
Detector 2 Extend (s)		0.0			0.0			0.0				0.0
Turn Type	pm+pt	NA	Perm	pm+pt	NA	Perm	pm+pt	NA	Perm	pm+pt	NA	Perm
Protected Phases	5	2		1	6		3	8		7	4	
Permitted Phases	2		2	6		6	8		8	4		4

Lanes, Volumes, Timings
1: Walden Street & 104th Avenue



Lane Group	EBL	EBT	EBR	WBL	WBT	WBR	NBL	NBT	NBR	SBL	SBT	SBR
Detector Phase	5	2	2	1	6	6	3	8	8	7	4	4
Switch Phase												
Minimum Initial (s)	5.0	10.0	10.0	5.0	10.0	10.0	8.0	10.0	10.0	8.0	10.0	10.0
Minimum Split (s)	12.5	17.5	17.5	12.5	17.5	17.5	14.5	16.5	16.5	14.5	16.5	16.5
Total Split (s)	19.0	50.0	50.0	13.0	44.0	44.0	20.0	17.0	17.0	40.0	37.0	37.0
Total Split (%)	15.8%	41.7%	41.7%	10.8%	36.7%	36.7%	16.7%	14.2%	14.2%	33.3%	30.8%	30.8%
Maximum Green (s)	11.5	42.5	42.5	5.5	36.5	36.5	13.5	10.5	10.5	33.5	30.5	30.5
Yellow Time (s)	5.3	5.3	5.3	5.3	5.3	5.3	3.8	3.8	3.8	3.8	3.8	3.8
All-Red Time (s)	2.2	2.2	2.2	2.2	2.2	2.2	2.7	2.7	2.7	2.7	2.7	2.7
Lost Time Adjust (s)	0.0	0.0	0.0	0.0	0.0	0.0	0.0	0.0	0.0	0.0	0.0	0.0
Total Lost Time (s)	7.5	7.5	7.5	7.5	7.5	7.5	6.5	6.5	6.5	6.5	6.5	6.5
Lead/Lag	Lead	Lag	Lag	Lead	Lag	Lag	Lead	Lag	Lag	Lead	Lag	Lag
Lead-Lag Optimize?	Yes	Yes	Yes	Yes	Yes	Yes	Yes	Yes	Yes	Yes	Yes	Yes
Vehicle Extension (s)	3.0	5.0	5.0	3.0	5.0	5.0	2.0	2.0	2.0	2.0	2.0	2.0
Recall Mode	None	C-Max	C-Max	None	C-Max	C-Max	None	None	None	None	None	None
Act Effct Green (s)	69.9	64.1	64.1	62.7	56.5	56.5	20.8	10.1	10.1	31.7	14.3	14.3
Actuated g/C Ratio	0.58	0.53	0.53	0.52	0.47	0.47	0.17	0.08	0.08	0.26	0.12	0.12
v/c Ratio	0.18	0.46	0.11	0.07	0.25	0.14	0.66	0.29	0.25	0.57	0.20	0.32
Control Delay	12.0	20.3	0.2	3.8	8.9	1.9	48.1	56.9	1.8	41.0	47.9	3.6
Queue Delay	0.0	0.0	0.0	0.0	0.0	0.0	0.0	0.0	0.0	0.0	0.0	0.0
Total Delay	12.0	20.3	0.2	3.8	8.9	1.9	48.1	56.9	1.8	41.0	47.9	3.6
LOS	B	C	A	A	A	A	D	E	A	D	D	A
Approach Delay		17.6			7.2			36.7			30.7	
Approach LOS		B			A			D			C	

Intersection Summary

Area Type:	Other
Cycle Length:	120
Actuated Cycle Length:	120
Offset:	10 (8%), Referenced to phase 2:EBTL and 6:WBTL, Start of Yellow
Natural Cycle:	70
Control Type:	Actuated-Coordinated
Maximum v/c Ratio:	0.66
Intersection Signal Delay:	19.8
Intersection LOS:	B
Intersection Capacity Utilization:	60.6%
ICU Level of Service:	B
Analysis Period (min):	15

Splits and Phases: 1: Walden Street & 104th Avenue

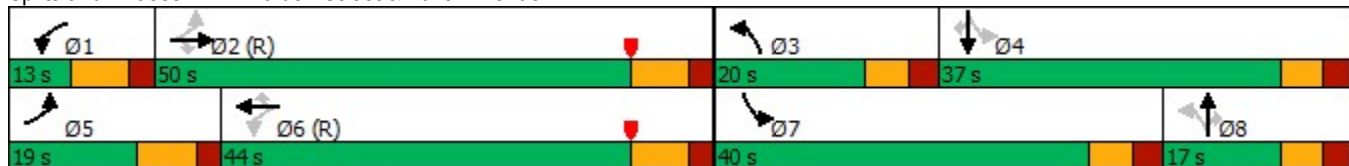

Queues
1: Walden Street & 104th Avenue



Lane Group	EBL	EBT	EBR	WBL	WBT	WBR	NBL	NBT	NBR	SBL	SBT	SBR
Lane Group Flow (vph)	100	863	103	22	413	120	183	46	86	212	44	109
v/c Ratio	0.18	0.46	0.11	0.07	0.25	0.14	0.66	0.29	0.25	0.57	0.20	0.32
Control Delay	12.0	20.3	0.2	3.8	8.9	1.9	48.1	56.9	1.8	41.0	47.9	3.6
Queue Delay	0.0	0.0	0.0	0.0	0.0	0.0	0.0	0.0	0.0	0.0	0.0	0.0
Total Delay	12.0	20.3	0.2	3.8	8.9	1.9	48.1	56.9	1.8	41.0	47.9	3.6
Queue Length 50th (ft)	30	228	0	1	60	0	115	34	0	135	32	0
Queue Length 95th (ft)	56	330	0	m9	81	0	152	63	0	175	55	0
Internal Link Dist (ft)		69			687			619			124	
Turn Bay Length (ft)	400		250	250			220		220	210		130
Base Capacity (vph)	593	1889	946	335	1666	860	290	163	345	506	473	527
Starvation Cap Reductn	0	0	0	0	0	0	0	0	0	0	0	0
Spillback Cap Reductn	0	0	0	0	0	0	0	0	0	0	0	0
Storage Cap Reductn	0	0	0	0	0	0	0	0	0	0	0	0
Reduced v/c Ratio	0.17	0.46	0.11	0.07	0.25	0.14	0.63	0.28	0.25	0.42	0.09	0.21

Intersection Summary

m Volume for 95th percentile queue is metered by upstream signal.

HCM 6th Signalized Intersection Summary
 1: Walden Street & 104th Avenue

JR Engineering
 10/03/2023



Movement	EBL	EBT	EBR	WBL	WBT	WBR	NBL	NBT	NBR	SBL	SBT	SBR
Lane Configurations												
Traffic Volume (veh/h)	80	794	82	17	363	96	154	36	68	178	34	86
Future Volume (veh/h)	80	794	82	17	363	96	154	36	68	178	34	86
Initial Q (Qb), veh	0	0	0	0	0	0	0	0	0	0	0	0
Ped-Bike Adj(A_pbT)	1.00		1.00	1.00		1.00	1.00		1.00	1.00		1.00
Parking Bus, Adj	1.00	1.00	1.00	1.00	1.00	1.00	1.00	1.00	1.00	1.00	1.00	1.00
Work Zone On Approach		No			No			No			No	
Adj Sat Flow, veh/h/ln	1870	1870	1870	1870	1870	1870	1870	1870	1870	1870	1870	1870
Adj Flow Rate, veh/h	100	863	102	22	412	120	183	46	86	212	44	109
Peak Hour Factor	0.80	0.92	0.80	0.78	0.88	0.80	0.84	0.78	0.79	0.84	0.78	0.79
Percent Heavy Veh, %	2	2	2	2	2	2	2	2	2	2	2	2
Cap, veh/h	497	1905	850	324	1832	817	351	156	132	360	187	159
Arrive On Green	0.04	0.54	0.54	0.01	0.17	0.17	0.11	0.08	0.08	0.13	0.10	0.10
Sat Flow, veh/h	1781	3554	1585	1781	3554	1585	1781	1870	1585	1781	1870	1585
Grp Volume(v), veh/h	100	863	102	22	412	120	183	46	86	212	44	109
Grp Sat Flow(s),veh/h/ln	1781	1777	1585	1781	1777	1585	1781	1870	1585	1781	1870	1585
Q Serve(g_s), s	3.2	17.9	3.8	0.7	12.0	7.7	11.1	2.8	6.3	12.8	2.6	8.0
Cycle Q Clear(g_c), s	3.2	17.9	3.8	0.7	12.0	7.7	11.1	2.8	6.3	12.8	2.6	8.0
Prop In Lane	1.00		1.00	1.00		1.00	1.00		1.00	1.00		1.00
Lane Grp Cap(c), veh/h	497	1905	850	324	1832	817	351	156	132	360	187	159
V/C Ratio(X)	0.20	0.45	0.12	0.07	0.22	0.15	0.52	0.30	0.65	0.59	0.24	0.69
Avail Cap(c_a), veh/h	593	1905	850	367	1832	817	357	164	139	633	475	403
HCM Platoon Ratio	1.00	1.00	1.00	0.33	0.33	0.33	1.00	1.00	1.00	1.00	1.00	1.00
Upstream Filter(l)	1.00	1.00	1.00	1.00	1.00	1.00	1.00	1.00	1.00	1.00	1.00	1.00
Uniform Delay (d), s/veh	13.1	17.1	13.8	14.3	29.1	27.3	43.6	51.7	53.3	42.7	49.8	52.2
Incr Delay (d2), s/veh	0.2	0.8	0.3	0.1	0.3	0.4	0.6	0.4	7.3	0.6	0.2	2.0
Initial Q Delay(d3),s/veh	0.0	0.0	0.0	0.0	0.0	0.0	0.0	0.0	0.0	0.0	0.0	0.0
%ile BackOfQ(50%),veh/ln	1.2	7.0	1.4	0.3	5.6	3.2	5.0	1.3	2.8	5.7	1.2	3.3
Unsig. Movement Delay, s/veh												
LnGrp Delay(d),s/veh	13.3	17.8	14.1	14.3	29.4	27.7	44.2	52.1	60.6	43.2	50.0	54.2
LnGrp LOS	B	B	B	B	C	C	D	D	E	D	D	D
Approach Vol, veh/h		1065			554			315			365	
Approach Delay, s/veh		17.1			28.4			49.8			47.3	
Approach LOS		B			C			D			D	
Timer - Assigned Phs	1	2	3	4	5	6	7	8				
Phs Duration (G+Y+Rc), s	10.1	71.8	19.6	18.5	12.6	69.4	21.6	16.5				
Change Period (Y+Rc), s	* 7.5	* 7.5	6.5	6.5	* 7.5	* 7.5	6.5	6.5				
Max Green Setting (Gmax), s	* 5.5	* 43	13.5	30.5	* 12	* 37	33.5	10.5				
Max Q Clear Time (g_c+l1), s	2.7	19.9	13.1	10.0	5.2	14.0	14.8	8.3				
Green Ext Time (p_c), s	0.0	10.9	0.0	0.3	0.1	5.4	0.3	0.1				

Intersection Summary

HCM 6th Ctrl Delay	29.1
HCM 6th LOS	C

Notes

* HCM 6th computational engine requires equal clearance times for the phases crossing the barrier.

Lanes, Volumes, Timings
2: Yampa Street & 104th Avenue

	→	↘	↙	←	↖	↗
Lane Group	EBT	EBR	WBL	WBT	NBL	NBR
Lane Configurations	↑↑↑	↑	↓	↑↑↑		↓
Traffic Volume (vph)	1023	55	32	496	0	24
Future Volume (vph)	1023	55	32	496	0	24
Ideal Flow (vphpl)	1900	1900	1900	1900	1900	1900
Storage Length (ft)		50	50		0	0
Storage Lanes		1	1		0	1
Taper Length (ft)			25		25	
Lane Util. Factor	0.91	1.00	1.00	0.91	1.00	1.00
Frt		0.850				0.865
Flt Protected			0.950			
Satd. Flow (prot)	5085	1583	1770	5085	0	1611
Flt Permitted			0.950			
Satd. Flow (perm)	5085	1583	1770	5085	0	1611
Link Speed (mph)	35			45	30	
Link Distance (ft)	767			1110	440	
Travel Time (s)	14.9			16.8	10.0	
Peak Hour Factor	0.93	0.78	0.78	0.88	0.78	0.78
Adj. Flow (vph)	1100	71	41	564	0	31
Shared Lane Traffic (%)						
Lane Group Flow (vph)	1100	71	41	564	0	31
Enter Blocked Intersection	No	No	No	No	No	No
Lane Alignment	Left	Right	Left	Left	Left	Right
Median Width(ft)	12			12	0	
Link Offset(ft)	0			0	0	
Crosswalk Width(ft)	16			16	16	
Two way Left Turn Lane						
Headway Factor	1.00	1.00	1.00	1.00	1.00	1.00
Turning Speed (mph)		9	15		15	9
Sign Control	Free			Free	Stop	
Intersection Summary						
Area Type:	Other					
Control Type:	Unsignalized					
Intersection Capacity Utilization	29.8%			ICU Level of Service A		
Analysis Period (min)	15					

Intersection						
Int Delay, s/veh	0.6					
Movement	EBT	EBR	WBL	WBT	NBL	NBR
Lane Configurations	↑↑↑	↑	↑	↑↑↑		↑
Traffic Vol, veh/h	1023	55	32	496	0	24
Future Vol, veh/h	1023	55	32	496	0	24
Conflicting Peds, #/hr	0	0	0	0	0	0
Sign Control	Free	Free	Free	Free	Stop	Stop
RT Channelized	-	None	-	None	-	None
Storage Length	-	50	50	-	-	0
Veh in Median Storage, #	0	-	-	0	0	-
Grade, %	0	-	-	0	0	-
Peak Hour Factor	93	78	78	88	78	78
Heavy Vehicles, %	2	2	2	2	2	2
Mvmt Flow	1100	71	41	564	0	31

Major/Minor	Major1	Major2	Minor1		
Conflicting Flow All	0	0	1171	0	- 550
Stage 1	-	-	-	-	-
Stage 2	-	-	-	-	-
Critical Hdwy	-	-	5.34	-	- 7.14
Critical Hdwy Stg 1	-	-	-	-	-
Critical Hdwy Stg 2	-	-	-	-	-
Follow-up Hdwy	-	-	3.12	-	- 3.92
Pot Cap-1 Maneuver	-	-	323	-	0 410
Stage 1	-	-	-	-	0 -
Stage 2	-	-	-	-	0 -
Platoon blocked, %	-	-	-	-	-
Mov Cap-1 Maneuver	-	-	323	-	- 410
Mov Cap-2 Maneuver	-	-	-	-	-
Stage 1	-	-	-	-	-
Stage 2	-	-	-	-	-

Approach	EB	WB	NB
HCM Control Delay, s	0	1.2	14.5
HCM LOS			B

Minor Lane/Major Mvmt	NBLn1	EBT	EBR	WBL	WBT
Capacity (veh/h)	410	-	-	323	-
HCM Lane V/C Ratio	0.075	-	-	0.127	-
HCM Control Delay (s)	14.5	-	-	17.8	-
HCM Lane LOS	B	-	-	C	-
HCM 95th %tile Q(veh)	0.2	-	-	0.4	-

Lanes, Volumes, Timings
3: Tower Road & 104th Avenue



Lane Group	EBL	EBT	EBR	WBL	WBT	WBR	NBL	NBT	NBR	SBL	SBT	SBR
Lane Configurations												
Traffic Volume (vph)	134	309	593	41	110	6	297	482	62	15	646	110
Future Volume (vph)	134	309	593	41	110	6	297	482	62	15	646	110
Ideal Flow (vphp)	1900	1900	1900	1900	1900	1900	1900	1900	1900	1900	1900	1900
Storage Length (ft)	420		0	475		300	160		0	250		0
Storage Lanes	1		1	1		1	2		1	1		1
Taper Length (ft)	25			25			25			25		
Lane Util. Factor	1.00	0.91	1.00	1.00	0.91	1.00	0.97	0.95	1.00	1.00	0.95	1.00
Frt			0.850			0.850			0.850			0.850
Flt Protected	0.950			0.950			0.950			0.950		
Satd. Flow (prot)	1770	5085	1583	1770	5085	1583	3433	3539	1583	1770	3539	1583
Flt Permitted	0.513			0.533			0.950			0.950		
Satd. Flow (perm)	956	5085	1583	993	5085	1583	3433	3539	1583	1770	3539	1583
Right Turn on Red			Yes			Yes			Yes			Yes
Satd. Flow (RTOR)			557			264			182			256
Link Speed (mph)		45			45			50			50	
Link Distance (ft)		1110			840			620			1000	
Travel Time (s)		16.8			12.7			8.5			13.6	
Peak Hour Factor	0.84	0.88	0.92	0.78	0.83	0.78	0.88	0.88	0.79	0.78	0.92	0.83
Adj. Flow (vph)	160	351	645	53	133	8	338	548	78	19	702	133
Shared Lane Traffic (%)												
Lane Group Flow (vph)	160	351	645	53	133	8	338	548	78	19	702	133
Enter Blocked Intersection	No	No	No	No	No	No	No	No	No	No	No	No
Lane Alignment	Left	Left	Right	Left	Left	Right	Left	Left	Right	Left	Left	Right
Median Width(ft)		12			12			24			24	
Link Offset(ft)		0			0			0			0	
Crosswalk Width(ft)		16			16			16			16	
Two way Left Turn Lane												
Headway Factor	1.00	1.00	1.00	1.00	1.00	1.00	1.00	1.00	1.00	1.00	1.00	1.00
Turning Speed (mph)	15		9	15		9	15		9	15		9
Number of Detectors	1	1	1	1	1	1	1	1	1	1	1	1
Detector Template	Left	Thru	Right	Left	Thru	Right	Left	Thru	Right	Left	Thru	Right
Leading Detector (ft)	40	40	40	40	40	40	40	40	40	40	40	40
Trailing Detector (ft)	0	0	0	0	0	0	0	0	0	0	0	0
Detector 1 Position(ft)	0	0	0	0	0	0	0	0	0	0	0	0
Detector 1 Size(ft)	40	40	40	40	40	40	40	40	40	40	40	40
Detector 1 Type	Cl+Ex	Cl+Ex	Cl+Ex	Cl+Ex	Cl+Ex	Cl+Ex	Cl+Ex	Cl+Ex	Cl+Ex	Cl+Ex	Cl+Ex	Cl+Ex
Detector 1 Channel												
Detector 1 Extend (s)	0.0	0.0	0.0	0.0	0.0	0.0	0.0	0.0	0.0	0.0	0.0	0.0
Detector 1 Queue (s)	0.0	0.0	0.0	0.0	0.0	0.0	0.0	0.0	0.0	0.0	0.0	0.0
Detector 1 Delay (s)	0.0	0.0	0.0	0.0	0.0	0.0	0.0	0.0	0.0	0.0	0.0	0.0
Turn Type	pm+pt	NA	Perm	pm+pt	NA	Perm	Prot	NA	Perm	Prot	NA	Perm
Protected Phases	7	4		3	8		5	2		1	6	
Permitted Phases	4		4	8		8			2			6
Detector Phase	7	4	4	3	8	8	5	2	2	1	6	6
Switch Phase												
Minimum Initial (s)	8.0	10.0	10.0	8.0	10.0	10.0	8.0	10.0	10.0	8.0	10.0	10.0
Minimum Split (s)	15.4	38.0	38.0	15.4	36.0	36.0	16.2	39.0	39.0	16.2	30.0	30.0
Total Split (s)	20.0	38.0	38.0	18.0	36.0	36.0	34.0	39.0	39.0	25.0	30.0	30.0

Lanes, Volumes, Timings
3: Tower Road & 104th Avenue

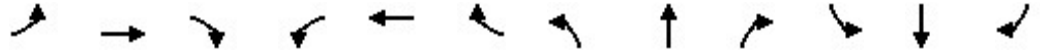

Lane Group	EBL	EBT	EBR	WBL	WBT	WBR	NBL	NBT	NBR	SBL	SBT	SBR
Total Split (%)	16.7%	31.7%	31.7%	15.0%	30.0%	30.0%	28.3%	32.5%	32.5%	20.8%	25.0%	25.0%
Maximum Green (s)	12.6	30.6	30.6	10.6	28.6	28.6	25.8	30.8	30.8	16.8	21.8	21.8
Yellow Time (s)	5.0	5.0	5.0	5.0	5.0	5.0	5.1	5.1	5.1	5.1	5.1	5.1
All-Red Time (s)	2.4	2.4	2.4	2.4	2.4	2.4	3.1	3.1	3.1	3.1	3.1	3.1
Lost Time Adjust (s)	0.0	0.0	0.0	0.0	0.0	0.0	0.0	0.0	0.0	0.0	0.0	0.0
Total Lost Time (s)	7.4	7.4	7.4	7.4	7.4	7.4	8.2	8.2	8.2	8.2	8.2	8.2
Lead/Lag	Lead	Lag	Lag	Lead	Lag	Lag	Lead	Lag	Lag	Lead	Lag	Lag
Lead-Lag Optimize?	Yes	Yes	Yes	Yes	Yes	Yes	Yes	Yes	Yes	Yes	Yes	Yes
Vehicle Extension (s)	2.0	2.0	2.0	2.0	2.0	2.0	2.0	5.0	5.0	2.0	5.0	5.0
Recall Mode	None	None	None	None	None	None	None	C-Min	C-Min	None	C-Min	C-Min
Act Effct Green (s)	32.3	22.4	22.4	24.1	15.9	15.9	16.2	63.0	63.0	8.0	45.1	45.1
Actuated g/C Ratio	0.27	0.19	0.19	0.20	0.13	0.13	0.14	0.52	0.52	0.07	0.38	0.38
v/c Ratio	0.48	0.37	0.86	0.21	0.20	0.02	0.73	0.30	0.09	0.16	0.53	0.18
Control Delay	30.4	38.7	29.2	30.5	45.0	0.0	59.3	19.9	0.2	56.3	33.5	0.5
Queue Delay	0.0	0.0	0.0	0.0	0.0	0.0	0.0	0.0	0.0	0.0	0.0	0.0
Total Delay	30.4	38.7	29.2	30.5	45.0	0.0	59.3	19.9	0.2	56.3	33.5	0.5
LOS	C	D	C	C	D	A	E	B	A	E	C	A
Approach Delay		32.3			39.2			32.1			28.9	
Approach LOS		C			D			C			C	

Intersection Summary

Area Type:	Other
Cycle Length:	120
Actuated Cycle Length:	120
Offset: 0 (0%), Referenced to phase 2:NBT and 6:SBT, Start of Yellow, Master Intersection	
Natural Cycle:	110
Control Type:	Actuated-Coordinated
Maximum v/c Ratio:	0.86
Intersection Signal Delay:	31.7
Intersection LOS:	C
Intersection Capacity Utilization	80.4%
ICU Level of Service	D
Analysis Period (min)	15

Splits and Phases: 3: Tower Road & 104th Avenue

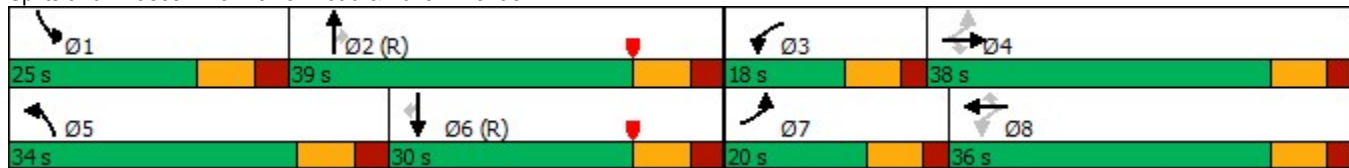

Queues
3: Tower Road & 104th Avenue



Lane Group	EBL	EBT	EBR	WBL	WBT	WBR	NBL	NBT	NBR	SBL	SBT	SBR
Lane Group Flow (vph)	160	351	645	53	133	8	338	548	78	19	702	133
v/c Ratio	0.48	0.37	0.86	0.21	0.20	0.02	0.73	0.30	0.09	0.16	0.53	0.18
Control Delay	30.4	38.7	29.2	30.5	45.0	0.0	59.3	19.9	0.2	56.3	33.5	0.5
Queue Delay	0.0	0.0	0.0	0.0	0.0	0.0	0.0	0.0	0.0	0.0	0.0	0.0
Total Delay	30.4	38.7	29.2	30.5	45.0	0.0	59.3	19.9	0.2	56.3	33.5	0.5
Queue Length 50th (ft)	107	96	249	31	35	0	131	96	0	14	208	0
Queue Length 95th (ft)	110	115	413	45	44	0	170	224	0	34	#381	0
Internal Link Dist (ft)		1030			760			540			920	
Turn Bay Length (ft)	420			475		300	160			250		
Base Capacity (vph)	344	1310	821	288	1211	578	738	1857	917	247	1330	754
Starvation Cap Reductn	0	0	0	0	0	0	0	0	0	0	0	0
Spillback Cap Reductn	0	0	0	0	0	0	0	0	0	0	0	0
Storage Cap Reductn	0	0	0	0	0	0	0	0	0	0	0	0
Reduced v/c Ratio	0.47	0.27	0.79	0.18	0.11	0.01	0.46	0.30	0.09	0.08	0.53	0.18

Intersection Summary

95th percentile volume exceeds capacity, queue may be longer.
Queue shown is maximum after two cycles.

HCM 6th Signalized Intersection Summary
3: Tower Road & 104th Avenue



Movement	EBL	EBT	EBR	WBL	WBT	WBR	NBL	NBT	NBR	SBL	SBT	SBR
Lane Configurations	↘	↑↑↑	↗	↘	↑↑↑	↗	↘↗	↑↑	↗	↘	↑↑	↗
Traffic Volume (veh/h)	134	309	593	41	110	6	297	482	62	15	646	110
Future Volume (veh/h)	134	309	593	41	110	6	297	482	62	15	646	110
Initial Q (Qb), veh	0	0	0	0	0	0	0	0	0	0	0	0
Ped-Bike Adj(A_pbT)	1.00		1.00	1.00		1.00	1.00		1.00	1.00		1.00
Parking Bus, Adj	1.00	1.00	1.00	1.00	1.00	1.00	1.00	1.00	1.00	1.00	1.00	1.00
Work Zone On Approach		No			No			No			No	
Adj Sat Flow, veh/h/ln	1870	1870	1870	1870	1870	1870	1870	1870	1870	1870	1870	1870
Adj Flow Rate, veh/h	160	351	0	53	133	0	338	548	0	19	702	0
Peak Hour Factor	0.84	0.88	0.92	0.78	0.83	0.78	0.88	0.88	0.79	0.78	0.92	0.83
Percent Heavy Veh, %	2	2	2	2	2	2	2	2	2	2	2	2
Cap, veh/h	308	642		219	426		406	1875		56	1569	
Arrive On Green	0.03	0.04	0.00	0.06	0.08	0.00	0.12	0.53	0.00	0.03	0.44	0.00
Sat Flow, veh/h	1781	5106	1585	1781	5106	1585	3456	3554	1585	1781	3554	1585
Grp Volume(v), veh/h	160	351	0	53	133	0	338	548	0	19	702	0
Grp Sat Flow(s),veh/h/ln	1781	1702	1585	1781	1702	1585	1728	1777	1585	1781	1777	1585
Q Serve(g_s), s	9.8	8.1	0.0	3.2	2.9	0.0	11.5	10.3	0.0	1.3	16.5	0.0
Cycle Q Clear(g_c), s	9.8	8.1	0.0	3.2	2.9	0.0	11.5	10.3	0.0	1.3	16.5	0.0
Prop In Lane	1.00		1.00	1.00		1.00	1.00		1.00	1.00		1.00
Lane Grp Cap(c), veh/h	308	642		219	426		406	1875		56	1569	
V/C Ratio(X)	0.52	0.55		0.24	0.31		0.83	0.29		0.34	0.45	
Avail Cap(c_a), veh/h	321	1302		277	1217		743	1875		249	1569	
HCM Platoon Ratio	0.33	0.33	0.33	1.00	1.00	1.00	1.00	1.00	1.00	1.00	1.00	1.00
Upstream Filter(l)	1.00	1.00	0.00	1.00	1.00	0.00	1.00	1.00	0.00	1.00	1.00	0.00
Uniform Delay (d), s/veh	47.5	54.2	0.0	45.9	51.8	0.0	51.8	15.8	0.0	56.9	23.3	0.0
Incr Delay (d2), s/veh	0.5	0.3	0.0	0.2	0.2	0.0	1.7	0.4	0.0	1.3	0.9	0.0
Initial Q Delay(d3),s/veh	0.0	0.0	0.0	0.0	0.0	0.0	0.0	0.0	0.0	0.0	0.0	0.0
%ile BackOfQ(50%),veh/ln	4.5	3.6	0.0	1.4	1.2	0.0	4.9	4.0	0.0	0.6	6.7	0.0
Unsig. Movement Delay, s/veh												
LnGrp Delay(d),s/veh	48.0	54.4	0.0	46.1	51.9	0.0	53.6	16.2	0.0	58.2	24.2	0.0
LnGrp LOS	D	D		D	D		D	B		E	C	
Approach Vol, veh/h		511			186			886			721	
Approach Delay, s/veh		52.4			50.3			30.5			25.1	
Approach LOS		D			D			C			C	
Timer - Assigned Phs	1	2	3	4	5	6	7	8				
Phs Duration (G+Y+Rc), s	12.0	71.5	14.0	22.5	22.3	61.2	19.1	17.4				
Change Period (Y+Rc), s	8.2	8.2	7.4	7.4	8.2	8.2	7.4	7.4				
Max Green Setting (Gmax), s	16.8	30.8	10.6	30.6	25.8	21.8	12.6	28.6				
Max Q Clear Time (g_c+I1), s	3.3	12.3	5.2	10.1	13.5	18.5	11.8	4.9				
Green Ext Time (p_c), s	0.0	4.3	0.0	0.8	0.6	1.7	0.0	0.3				

Intersection Summary

HCM 6th Ctrl Delay	35.3
HCM 6th LOS	D

Notes

- User approved pedestrian interval to be less than phase max green.
- Unsignalized Delay for [NBR, EBR, WBR, SBR] is excluded from calculations of the approach delay and intersection delay.

Lanes, Volumes, Timings
4: Tower Road & Private Access



Lane Group	EBL	EBR	NBL	NBT	SBT	SBR
Lane Configurations						
Traffic Volume (vph)	0	33	0	767	1149	83
Future Volume (vph)	0	33	0	767	1149	83
Ideal Flow (vphpl)	1900	1900	1900	1900	1900	1900
Lane Util. Factor	1.00	1.00	1.00	0.95	0.91	0.91
Fr _t		0.865			0.988	
Fl _t Protected						
Satd. Flow (prot)	0	1611	0	3539	5024	0
Fl _t Permitted						
Satd. Flow (perm)	0	1611	0	3539	5024	0
Link Speed (mph)	30			50	30	
Link Distance (ft)	345			530	620	
Travel Time (s)	7.8			7.2	14.1	
Peak Hour Factor	0.78	0.78	0.78	0.92	0.93	0.80
Adj. Flow (vph)	0	42	0	834	1235	104
Shared Lane Traffic (%)						
Lane Group Flow (vph)	0	42	0	834	1339	0
Enter Blocked Intersection	No	No	No	No	No	No
Lane Alignment	Left	Right	Left	Left	Left	Right
Median Width(ft)	0			24	24	
Link Offset(ft)	0			0	0	
Crosswalk Width(ft)	16			16	16	
Two way Left Turn Lane						
Headway Factor	1.00	1.00	1.00	1.00	1.00	1.00
Turning Speed (mph)	15	9	15			9
Sign Control	Stop			Free	Free	

Intersection Summary

Area Type:	Other
Control Type:	Unsignalized
Intersection Capacity Utilization	34.0%
ICU Level of Service	A
Analysis Period (min)	15

Intersection						
Int Delay, s/veh	0.3					
Movement	EBL	EBR	NBL	NBT	SBT	SBR
Lane Configurations		↗		↑↑	↑↑↑	
Traffic Vol, veh/h	0	33	0	767	1149	83
Future Vol, veh/h	0	33	0	767	1149	83
Conflicting Peds, #/hr	0	0	0	0	0	0
Sign Control	Stop	Stop	Free	Free	Free	Free
RT Channelized	-	None	-	None	-	None
Storage Length	-	0	-	-	-	-
Veh in Median Storage, #	0	-	-	0	0	-
Grade, %	0	-	-	0	0	-
Peak Hour Factor	78	78	78	92	93	80
Heavy Vehicles, %	2	2	2	2	2	2
Mvmt Flow	0	42	0	834	1235	104

Major/Minor	Minor2	Major1	Major2		
Conflicting Flow All	-	670	-	0	-
Stage 1	-	-	-	-	-
Stage 2	-	-	-	-	-
Critical Hdwy	-	7.14	-	-	-
Critical Hdwy Stg 1	-	-	-	-	-
Critical Hdwy Stg 2	-	-	-	-	-
Follow-up Hdwy	-	3.92	-	-	-
Pot Cap-1 Maneuver	0	343	0	-	-
Stage 1	0	-	0	-	-
Stage 2	0	-	0	-	-
Platoon blocked, %				-	-
Mov Cap-1 Maneuver	-	343	-	-	-
Mov Cap-2 Maneuver	-	-	-	-	-
Stage 1	-	-	-	-	-
Stage 2	-	-	-	-	-

Approach	EB	NB	SB
HCM Control Delay, s	17	0	0
HCM LOS	C		

Minor Lane/Major Mvmt	NBT	EBLn1	SBT	SBR
Capacity (veh/h)	-	343	-	-
HCM Lane V/C Ratio	-	0.123	-	-
HCM Control Delay (s)	-	17	-	-
HCM Lane LOS	-	C	-	-
HCM 95th %tile Q(veh)	-	0.4	-	-

Lanes, Volumes, Timings
5: 103rd Avenue & Tower Road

JR Engineering
10/03/2023

Lane Group	EBL	EBT	EBR	WBL	WBT	WBR	NBL	NBT	NBR	SBL	SBT	SBR
Lane Configurations												
Traffic Volume (vph)	9	1	34	15	1	59	77	747	11	62	1181	15
Future Volume (vph)	9	1	34	15	1	59	77	747	11	62	1181	15
Ideal Flow (vphpl)	1900	1900	1900	1900	1900	1900	1900	1900	1900	1900	1900	1900
Storage Length (ft)	45		0	100		0	440		185	130		0
Storage Lanes	1		0	1		0	1		0	1		0
Taper Length (ft)	25			25			25			25		
Lane Util. Factor	1.00	1.00	1.00	1.00	1.00	1.00	1.00	0.95	0.95	1.00	0.91	0.91
Frt		0.853			0.852			0.997			0.998	
Flt Protected	0.950			0.950			0.950			0.950		
Satd. Flow (prot)	1770	1589	0	1770	1587	0	1770	3529	0	1770	5075	0
Flt Permitted	0.950			0.950			0.950			0.950		
Satd. Flow (perm)	1770	1589	0	1770	1587	0	1770	3529	0	1770	5075	0
Link Speed (mph)		30			30			30			30	
Link Distance (ft)		875			708			356			530	
Travel Time (s)		19.9			16.1			8.1			12.0	
Peak Hour Factor	0.78	0.78	0.78	0.78	0.78	0.78	0.80	0.92	0.78	0.78	0.93	0.78
Adj. Flow (vph)	12	1	44	19	1	76	96	812	14	79	1270	19
Shared Lane Traffic (%)												
Lane Group Flow (vph)	12	45	0	19	77	0	96	826	0	79	1289	0
Enter Blocked Intersection	No	No	No	No	No	No	No	No	No	No	No	No
Lane Alignment	Left	Left	Right	Left	Left	Right	Left	Left	Right	Left	Left	Right
Median Width(ft)		12			12			12			12	
Link Offset(ft)		0			0			0			0	
Crosswalk Width(ft)		16			16			16			16	
Two way Left Turn Lane												
Headway Factor	1.00	1.00	1.00	1.00	1.00	1.00	1.00	1.00	1.00	1.00	1.00	1.00
Turning Speed (mph)	15		9	15		9	15		9	15		9
Sign Control		Stop			Stop			Free			Free	

Intersection Summary

Area Type:	Other
Control Type:	Unsignalized
Intersection Capacity Utilization	44.9%
ICU Level of Service	A
Analysis Period (min)	15

Intersection												
Int Delay, s/veh	4.4											
Movement	EBL	EBT	EBR	WBL	WBT	WBR	NBL	NBT	NBR	SBL	SBT	SBR
Lane Configurations	↵	↵		↵	↵		↵	↵↵		↵	↵↵↵	
Traffic Vol, veh/h	9	1	34	15	1	59	77	747	11	62	1181	15
Future Vol, veh/h	9	1	34	15	1	59	77	747	11	62	1181	15
Conflicting Peds, #/hr	0	0	0	0	0	0	0	0	0	0	0	0
Sign Control	Stop	Stop	Stop	Stop	Stop	Stop	Free	Free	Free	Free	Free	Free
RT Channelized	-	-	None	-	-	None	-	-	None	-	-	None
Storage Length	45	-	-	100	-	-	440	-	-	130	-	-
Veh in Median Storage, #	-	0	-	-	0	-	-	0	-	-	0	-
Grade, %	-	0	-	-	0	-	-	0	-	-	0	-
Peak Hour Factor	78	78	78	78	78	78	80	92	78	78	93	78
Heavy Vehicles, %	2	2	2	2	2	2	2	2	2	2	2	2
Mvmt Flow	12	1	44	19	1	76	96	812	14	79	1270	19

Major/Minor	Minor2		Minor1		Major1		Major2					
Conflicting Flow All	2037	2456	645	1678	2458	413	1289	0	0	826	0	0
Stage 1	1438	1438	-	1011	1011	-	-	-	-	-	-	-
Stage 2	599	1018	-	667	1447	-	-	-	-	-	-	-
Critical Hdwy	6.99	6.54	7.14	6.99	6.54	6.94	5.34	-	-	4.14	-	-
Critical Hdwy Stg 1	7.34	5.54	-	6.54	5.54	-	-	-	-	-	-	-
Critical Hdwy Stg 2	6.54	5.54	-	6.74	5.54	-	-	-	-	-	-	-
Follow-up Hdwy	3.67	4.02	3.92	3.67	4.02	3.32	3.12	-	-	2.22	-	-
Pot Cap-1 Maneuver	45	30	356	79	30	588	283	-	-	800	-	-
Stage 1	100	197	-	250	315	-	-	-	-	-	-	-
Stage 2	441	313	-	388	195	-	-	-	-	-	-	-
Platoon blocked, %								-	-	-	-	-
Mov Cap-1 Maneuver	25	18	356	45	18	588	283	-	-	800	-	-
Mov Cap-2 Maneuver	25	18	-	45	18	-	-	-	-	-	-	-
Stage 1	66	177	-	165	208	-	-	-	-	-	-	-
Stage 2	252	207	-	305	176	-	-	-	-	-	-	-

Approach	EB		WB		NB		SB	
HCM Control Delay, s	68.1		40.4		2.5		0.6	
HCM LOS	F		E					

Minor Lane/Major Mvmt	NBL	NBT	NBR	EBLn1	EBLn2	WBLn1	WBLn2	SBL	SBT	SBR
Capacity (veh/h)	283	-	-	25	232	45	385	800	-	-
HCM Lane V/C Ratio	0.34	-	-	0.462	0.193	0.427	0.2	0.099	-	-
HCM Control Delay (s)	24.1	-	-	239	24.2	135	16.7	10	-	-
HCM Lane LOS	C	-	-	F	C	F	C	A	-	-
HCM 95th %tile Q(veh)	1.5	-	-	1.4	0.7	1.5	0.7	0.3	-	-

Lanes, Volumes, Timings
1: Walden Street & 104th Avenue

JR Engineering
10/03/2023

Lane Group	EBL	EBT	EBR	WBL	WBT	WBR	NBL	NBT	NBR	SBL	SBT	SBR
Lane Configurations												
Traffic Volume (vph)	24	551	128	20	732	89	193	42	37	59	14	19
Future Volume (vph)	24	551	128	20	732	89	193	42	37	59	14	19
Ideal Flow (vphpl)	1900	1900	1900	1900	1900	1900	1900	1900	1900	1900	1900	1900
Storage Length (ft)	400		250	250		0	220		220	210		130
Storage Lanes	1		1	1		1	1		1	1		1
Taper Length (ft)	25			25			25			25		
Lane Util. Factor	1.00	0.95	1.00	1.00	0.95	1.00	1.00	1.00	1.00	1.00	1.00	1.00
Frt			0.850			0.850			0.850			0.850
Flt Protected	0.950			0.950			0.950			0.950		
Satd. Flow (prot)	1770	3539	1583	1770	3539	1583	1770	1863	1583	1770	1863	1583
Flt Permitted	0.299			0.398			0.358			0.722		
Satd. Flow (perm)	557	3539	1583	741	3539	1583	667	1863	1583	1345	1863	1583
Right Turn on Red			Yes			Yes			Yes			Yes
Satd. Flow (RTOR)			218			218			227			168
Link Speed (mph)		45			45			30				30
Link Distance (ft)		149			767			699				204
Travel Time (s)		2.3			11.6			15.9				4.6
Peak Hour Factor	0.78	0.92	0.84	0.78	0.92	0.80	0.84	0.78	0.78	0.78	0.78	0.78
Adj. Flow (vph)	31	599	152	26	796	111	230	54	47	76	18	24
Shared Lane Traffic (%)												
Lane Group Flow (vph)	31	599	152	26	796	111	230	54	47	76	18	24
Enter Blocked Intersection	No	No	No	No	No	No	No	No	No	No	No	No
Lane Alignment	Left	Left	Right	Left	Left	Right	Left	Left	Right	Left	Left	Right
Median Width(ft)		12			12			12				12
Link Offset(ft)		0			0			0				0
Crosswalk Width(ft)		16			16			16				16
Two way Left Turn Lane												
Headway Factor	1.00	1.00	1.00	1.00	1.00	1.00	1.00	1.00	1.00	1.00	1.00	1.00
Turning Speed (mph)	15		9	15		9	15		9	15		9
Number of Detectors	1	2	1	1	2	1	1	2	1	1	2	1
Detector Template	Left	Thru	Right	Left	Thru	Right	Left	Thru	Right	Left	Thru	Right
Leading Detector (ft)	20	100	20	20	100	20	20	100	20	20	100	20
Trailing Detector (ft)	0	0	0	0	0	0	0	0	0	0	0	0
Detector 1 Position(ft)	0	0	0	0	0	0	0	0	0	0	0	0
Detector 1 Size(ft)	20	6	20	20	6	20	20	6	20	20	6	20
Detector 1 Type	Cl+Ex	Cl+Ex	Cl+Ex	Cl+Ex	Cl+Ex	Cl+Ex	Cl+Ex	Cl+Ex	Cl+Ex	Cl+Ex	Cl+Ex	Cl+Ex
Detector 1 Channel												
Detector 1 Extend (s)	0.0	0.0	0.0	0.0	0.0	0.0	0.0	0.0	0.0	0.0	0.0	0.0
Detector 1 Queue (s)	0.0	0.0	0.0	0.0	0.0	0.0	0.0	0.0	0.0	0.0	0.0	0.0
Detector 1 Delay (s)	0.0	0.0	0.0	0.0	0.0	0.0	0.0	0.0	0.0	0.0	0.0	0.0
Detector 2 Position(ft)		94			94			94				94
Detector 2 Size(ft)		6			6			6				6
Detector 2 Type		Cl+Ex			Cl+Ex			Cl+Ex				Cl+Ex
Detector 2 Channel												
Detector 2 Extend (s)		0.0			0.0			0.0				0.0
Turn Type	pm+pt	NA	Perm	pm+pt	NA	Perm	pm+pt	NA	Perm	pm+pt	NA	Perm
Protected Phases	5	2		1	6		3	8		7	4	
Permitted Phases	2		2	6		6	8		8	4		4

Lanes, Volumes, Timings
1: Walden Street & 104th Avenue



Lane Group	EBL	EBT	EBR	WBL	WBT	WBR	NBL	NBT	NBR	SBL	SBT	SBR
Detector Phase	5	2	2	1	6	6	3	8	8	7	4	4
Switch Phase												
Minimum Initial (s)	5.0	10.0	10.0	5.0	10.0	10.0	8.0	10.0	10.0	8.0	10.0	10.0
Minimum Split (s)	12.5	17.5	17.5	12.5	17.5	17.5	14.5	16.5	16.5	14.5	16.5	16.5
Total Split (s)	18.0	57.0	57.0	13.0	52.0	52.0	25.0	17.0	17.0	33.0	25.0	25.0
Total Split (%)	15.0%	47.5%	47.5%	10.8%	43.3%	43.3%	20.8%	14.2%	14.2%	27.5%	20.8%	20.8%
Maximum Green (s)	10.5	49.5	49.5	5.5	44.5	44.5	18.5	10.5	10.5	26.5	18.5	18.5
Yellow Time (s)	5.3	5.3	5.3	5.3	5.3	5.3	3.8	3.8	3.8	3.8	3.8	3.8
All-Red Time (s)	2.2	2.2	2.2	2.2	2.2	2.2	2.7	2.7	2.7	2.7	2.7	2.7
Lost Time Adjust (s)	0.0	0.0	0.0	0.0	0.0	0.0	0.0	0.0	0.0	0.0	0.0	0.0
Total Lost Time (s)	7.5	7.5	7.5	7.5	7.5	7.5	6.5	6.5	6.5	6.5	6.5	6.5
Lead/Lag	Lead	Lag	Lag	Lead	Lag	Lag	Lead	Lag	Lag	Lead	Lag	Lag
Lead-Lag Optimize?	Yes	Yes	Yes	Yes	Yes	Yes	Yes	Yes	Yes	Yes	Yes	Yes
Vehicle Extension (s)	2.0	5.0	5.0	2.0	5.0	5.0	2.0	2.0	2.0	2.0	2.0	2.0
Recall Mode	None	C-Max	C-Max	None	C-Max	C-Max	None	None	None	None	None	None
Act Effect Green (s)	73.4	69.9	69.9	73.1	69.7	69.7	28.2	15.5	15.5	15.1	10.0	10.0
Actuated g/C Ratio	0.61	0.58	0.58	0.61	0.58	0.58	0.24	0.13	0.13	0.13	0.08	0.08
v/c Ratio	0.08	0.29	0.15	0.05	0.39	0.11	0.71	0.22	0.12	0.38	0.12	0.08
Control Delay	10.5	15.6	0.8	5.0	7.8	0.2	51.1	48.2	0.6	42.1	52.9	0.6
Queue Delay	0.0	0.0	0.0	0.0	0.0	0.0	0.0	0.0	0.0	0.0	0.0	0.0
Total Delay	10.5	15.6	0.8	5.0	7.8	0.2	51.1	48.2	0.6	42.1	52.9	0.6
LOS	B	B	A	A	A	A	D	D	A	D	D	A
Approach Delay		12.5			6.9			43.5			35.3	
Approach LOS		B			A			D			D	

Intersection Summary

Area Type:	Other
Cycle Length:	120
Actuated Cycle Length:	120
Offset:	0.7 (1%), Referenced to phase 2:EBTL and 6:WBTL, Start of Yellow
Natural Cycle:	70
Control Type:	Actuated-Coordinated
Maximum v/c Ratio:	0.71
Intersection Signal Delay:	16.1
Intersection LOS:	B
Intersection Capacity Utilization:	56.3%
ICU Level of Service:	B
Analysis Period (min):	15

Splits and Phases: 1: Walden Street & 104th Avenue

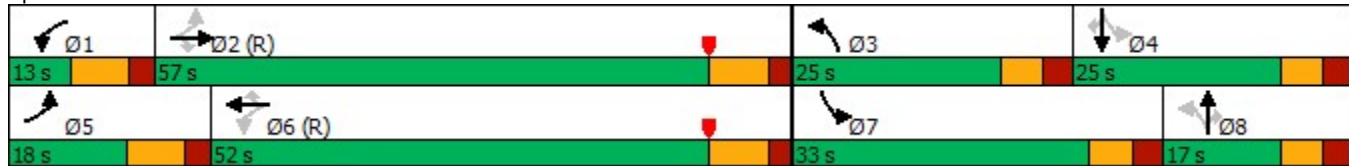

Queues
1: Walden Street & 104th Avenue



Lane Group	EBL	EBT	EBR	WBL	WBT	WBR	NBL	NBT	NBR	SBL	SBT	SBR
Lane Group Flow (vph)	31	599	152	26	796	111	230	54	47	76	18	24
v/c Ratio	0.08	0.29	0.15	0.05	0.39	0.11	0.71	0.22	0.12	0.38	0.12	0.08
Control Delay	10.5	15.6	0.8	5.0	7.8	0.2	51.1	48.2	0.6	42.1	52.9	0.6
Queue Delay	0.0	0.0	0.0	0.0	0.0	0.0	0.0	0.0	0.0	0.0	0.0	0.0
Total Delay	10.5	15.6	0.8	5.0	7.8	0.2	51.1	48.2	0.6	42.1	52.9	0.6
Queue Length 50th (ft)	9	144	0	4	125	1	147	37	0	44	13	0
Queue Length 95th (ft)	20	193	1	m7	165	m0	205	67	0	71	33	0
Internal Link Dist (ft)		69			687			619			124	
Turn Bay Length (ft)	400		250	250			220		220	210		130
Base Capacity (vph)	459	2060	1012	500	2056	1011	344	243	403	445	287	386
Starvation Cap Reductn	0	0	0	0	0	0	0	0	0	0	0	0
Spillback Cap Reductn	0	0	0	0	0	0	0	0	0	0	0	0
Storage Cap Reductn	0	0	0	0	0	0	0	0	0	0	0	0
Reduced v/c Ratio	0.07	0.29	0.15	0.05	0.39	0.11	0.67	0.22	0.12	0.17	0.06	0.06

Intersection Summary

m Volume for 95th percentile queue is metered by upstream signal.

HCM 6th Signalized Intersection Summary
 1: Walden Street & 104th Avenue



Movement	EBL	EBT	EBR	WBL	WBT	WBR	NBL	NBT	NBR	SBL	SBT	SBR
Lane Configurations	↖	↗	↘	↖	↗	↘	↖	↗	↘	↖	↗	↘
Traffic Volume (veh/h)	24	551	128	20	732	89	193	42	37	59	14	19
Future Volume (veh/h)	24	551	128	20	732	89	193	42	37	59	14	19
Initial Q (Qb), veh	0	0	0	0	0	0	0	0	0	0	0	0
Ped-Bike Adj(A_pbT)	1.00		1.00	1.00		1.00	1.00		1.00	1.00		1.00
Parking Bus, Adj	1.00	1.00	1.00	1.00	1.00	1.00	1.00	1.00	1.00	1.00	1.00	1.00
Work Zone On Approach		No			No			No			No	
Adj Sat Flow, veh/h/ln	1870	1870	1870	1870	1870	1870	1870	1870	1870	1870	1870	1870
Adj Flow Rate, veh/h	31	599	152	26	796	111	230	54	47	76	18	24
Peak Hour Factor	0.78	0.92	0.84	0.78	0.92	0.80	0.84	0.78	0.78	0.78	0.78	0.78
Percent Heavy Veh, %	2	2	2	2	2	2	2	2	2	2	2	2
Cap, veh/h	373	1876	837	457	1866	832	398	287	243	282	156	132
Arrive On Green	0.03	0.53	0.53	0.02	0.53	0.53	0.13	0.15	0.15	0.06	0.08	0.08
Sat Flow, veh/h	1781	3554	1585	1781	3554	1585	1781	1870	1585	1781	1870	1585
Grp Volume(v), veh/h	31	599	152	26	796	111	230	54	47	76	18	24
Grp Sat Flow(s),veh/h/ln	1781	1777	1585	1781	1777	1585	1781	1870	1585	1781	1870	1585
Q Serve(g_s), s	1.0	11.5	6.0	0.8	16.4	4.3	13.7	3.0	3.1	4.6	1.1	1.7
Cycle Q Clear(g_c), s	1.0	11.5	6.0	0.8	16.4	4.3	13.7	3.0	3.1	4.6	1.1	1.7
Prop In Lane	1.00		1.00	1.00		1.00	1.00		1.00	1.00		1.00
Lane Grp Cap(c), veh/h	373	1876	837	457	1866	832	398	287	243	282	156	132
V/C Ratio(X)	0.08	0.32	0.18	0.06	0.43	0.13	0.58	0.19	0.19	0.27	0.12	0.18
Avail Cap(c_a), veh/h	481	1876	837	496	1866	832	438	287	243	566	288	244
HCM Platoon Ratio	1.00	1.00	1.00	1.00	1.00	1.00	1.00	1.00	1.00	1.00	1.00	1.00
Upstream Filter(I)	1.00	1.00	1.00	1.00	1.00	1.00	1.00	1.00	1.00	1.00	1.00	1.00
Uniform Delay (d), s/veh	13.4	16.1	14.8	12.9	17.4	14.5	40.8	44.3	44.3	45.9	50.9	51.2
Incr Delay (d2), s/veh	0.0	0.4	0.5	0.0	0.7	0.3	0.8	0.1	0.1	0.2	0.1	0.2
Initial Q Delay(d3),s/veh	0.0	0.0	0.0	0.0	0.0	0.0	0.0	0.0	0.0	0.0	0.0	0.0
%ile BackOfQ(50%),veh/ln	0.4	4.5	2.3	0.3	6.5	1.6	6.1	1.4	1.2	2.0	0.5	0.7
Unsig. Movement Delay, s/veh												
LnGrp Delay(d),s/veh	13.5	16.5	15.3	12.9	18.1	14.9	41.5	44.4	44.5	46.0	51.0	51.4
LnGrp LOS	B	B	B	B	B	B	D	D	D	D	D	D
Approach Vol, veh/h		782			933			331			118	
Approach Delay, s/veh		16.2			17.6			42.4			47.9	
Approach LOS		B			B			D			D	
Timer - Assigned Phs	1	2	3	4	5	6	7	8				
Phs Duration (G+Y+Rc), s	10.4	70.8	22.3	16.5	10.7	70.5	13.9	24.9				
Change Period (Y+Rc), s	* 7.5	* 7.5	6.5	6.5	* 7.5	* 7.5	6.5	6.5				
Max Green Setting (Gmax), s	* 5.5	* 50	18.5	18.5	* 11	* 45	26.5	10.5				
Max Q Clear Time (g_c+I1), s	2.8	13.5	15.7	3.7	3.0	18.4	6.6	5.1				
Green Ext Time (p_c), s	0.0	9.6	0.1	0.0	0.0	10.9	0.1	0.1				

Intersection Summary

HCM 6th Ctrl Delay	22.5
HCM 6th LOS	C

Notes

* HCM 6th computational engine requires equal clearance times for the phases crossing the barrier.

Lanes, Volumes, Timings
2: Yampa Street & 104th Avenue

	→	↘	↙	←	↖	↗
Lane Group	EBT	EBR	WBL	WBT	NBL	NBR
Lane Configurations	↑↑↑	↗	↘	↑↑↑		↗
Traffic Volume (vph)	643	38	30	496	0	25
Future Volume (vph)	643	38	30	496	0	25
Ideal Flow (vphpl)	1900	1900	1900	1900	1900	1900
Storage Length (ft)		50	50		0	0
Storage Lanes		1	1		0	1
Taper Length (ft)			25		25	
Lane Util. Factor	0.91	1.00	1.00	0.91	1.00	1.00
Frt		0.850				0.865
Flt Protected			0.950			
Satd. Flow (prot)	5085	1583	1770	5085	0	1611
Flt Permitted			0.950			
Satd. Flow (perm)	5085	1583	1770	5085	0	1611
Link Speed (mph)	30			30	30	
Link Distance (ft)	767			1110	440	
Travel Time (s)	17.4			25.2	10.0	
Peak Hour Factor	0.92	0.78	0.78	0.88	0.78	0.78
Adj. Flow (vph)	699	49	38	564	0	32
Shared Lane Traffic (%)						
Lane Group Flow (vph)	699	49	38	564	0	32
Enter Blocked Intersection	No	No	No	No	No	No
Lane Alignment	Left	Right	Left	Left	Left	Right
Median Width(ft)	12			12	0	
Link Offset(ft)	0			0	0	
Crosswalk Width(ft)	16			16	16	
Two way Left Turn Lane						
Headway Factor	1.00	1.00	1.00	1.00	1.00	1.00
Turning Speed (mph)		60	60		60	60
Sign Control	Free			Free	Stop	

Intersection Summary

Area Type:	Other
Control Type:	Unsignalized
Intersection Capacity Utilization	22.4%
	ICU Level of Service A
Analysis Period (min)	15

Intersection						
Int Delay, s/veh	0.6					
Movement	EBT	EBR	WBL	WBT	NBL	NBR
Lane Configurations	↑↑↑	↑	↑	↑↑↑		↑
Traffic Vol, veh/h	643	38	30	496	0	25
Future Vol, veh/h	643	38	30	496	0	25
Conflicting Peds, #/hr	0	0	0	0	0	0
Sign Control	Free	Free	Free	Free	Stop	Stop
RT Channelized	-	None	-	None	-	None
Storage Length	-	50	50	-	-	0
Veh in Median Storage, #	0	-	-	0	0	-
Grade, %	0	-	-	0	0	-
Peak Hour Factor	92	78	78	88	78	78
Heavy Vehicles, %	2	2	2	2	2	2
Mvmt Flow	699	49	38	564	0	32

Major/Minor	Major1	Major2	Minor1		
Conflicting Flow All	0	0	748	0	- 350
Stage 1	-	-	-	-	-
Stage 2	-	-	-	-	-
Critical Hdwy	-	-	5.34	-	- 7.14
Critical Hdwy Stg 1	-	-	-	-	-
Critical Hdwy Stg 2	-	-	-	-	-
Follow-up Hdwy	-	-	3.12	-	- 3.92
Pot Cap-1 Maneuver	-	-	517	-	0 552
Stage 1	-	-	-	-	0 -
Stage 2	-	-	-	-	0 -
Platoon blocked, %	-	-	-	-	-
Mov Cap-1 Maneuver	-	-	517	-	- 552
Mov Cap-2 Maneuver	-	-	-	-	-
Stage 1	-	-	-	-	-
Stage 2	-	-	-	-	-

Approach	EB	WB	NB
HCM Control Delay, s	0	0.8	11.9
HCM LOS			B

Minor Lane/Major Mvmt	NBLn1	EBT	EBR	WBL	WBT
Capacity (veh/h)	552	-	-	517	-
HCM Lane V/C Ratio	0.058	-	-	0.074	-
HCM Control Delay (s)	11.9	-	-	12.5	-
HCM Lane LOS	B	-	-	B	-
HCM 95th %tile Q(veh)	0.2	-	-	0.2	-

Lanes, Volumes, Timings
3: Tower Road & 104th Avenue

Lane Group	EBL	EBT	EBR	WBL	WBT	WBR	NBL	NBT	NBR	SBL	SBT	SBR
Lane Configurations												
Traffic Volume (vph)	112	155	394	29	201	17	595	824	30	10	487	87
Future Volume (vph)	112	155	394	29	201	17	595	824	30	10	487	87
Ideal Flow (vphpl)	1900	1900	1900	1900	1900	1900	1900	1900	1900	1900	1900	1900
Storage Length (ft)	420		0	475		300	160		0	250		0
Storage Lanes	1		1	1		1	2		1	1		1
Taper Length (ft)	25			25			25			25		
Lane Util. Factor	1.00	0.91	1.00	1.00	0.91	1.00	0.97	0.95	1.00	1.00	0.95	1.00
Frt			0.850			0.850			0.850			0.850
Flt Protected	0.950			0.950			0.950			0.950		
Satd. Flow (prot)	1770	5085	1583	1770	5085	1583	3433	3539	1583	1770	3539	1583
Flt Permitted	0.476			0.630			0.950			0.950		
Satd. Flow (perm)	887	5085	1583	1174	5085	1583	3433	3539	1583	1770	3539	1583
Right Turn on Red			Yes			Yes			Yes			Yes
Satd. Flow (RTOR)			448			264			182			256
Link Speed (mph)		35			35			30			30	
Link Distance (ft)		1110			840			620			1000	
Travel Time (s)		21.6			16.4			14.1			22.7	
Peak Hour Factor	0.83	0.84	0.88	0.78	0.87	0.78	0.92	0.92	0.78	0.78	0.88	0.80
Adj. Flow (vph)	135	185	448	37	231	22	647	896	38	13	553	109
Shared Lane Traffic (%)												
Lane Group Flow (vph)	135	185	448	37	231	22	647	896	38	13	553	109
Enter Blocked Intersection	No	No	No	No	No	No	No	No	No	No	No	No
Lane Alignment	Left	Left	Right	Left	Left	Right	Left	Left	Right	Left	Left	Right
Median Width(ft)		12			12			24			24	
Link Offset(ft)		0			0			0			0	
Crosswalk Width(ft)		16			16			16			16	
Two way Left Turn Lane												
Headway Factor	1.00	1.00	1.00	1.00	1.00	1.00	1.00	1.00	1.00	1.00	1.00	1.00
Turning Speed (mph)	15		9	15		9	15		9	15		9
Number of Detectors	1	1	1	1	1	1	1	1	1	1	1	1
Detector Template	Left	Thru	Right	Left	Thru	Right	Left	Thru	Right	Left	Thru	Right
Leading Detector (ft)	40	40	40	40	40	40	40	40	40	40	40	40
Trailing Detector (ft)	0	0	0	0	0	0	0	0	0	0	0	0
Detector 1 Position(ft)	0	0	0	0	0	0	0	0	0	0	0	0
Detector 1 Size(ft)	40	40	40	40	40	40	40	40	40	40	40	40
Detector 1 Type	Cl+Ex	Cl+Ex	Cl+Ex	Cl+Ex	Cl+Ex	Cl+Ex	Cl+Ex	Cl+Ex	Cl+Ex	Cl+Ex	Cl+Ex	Cl+Ex
Detector 1 Channel												
Detector 1 Extend (s)	0.0	0.0	0.0	0.0	0.0	0.0	0.0	0.0	0.0	0.0	0.0	0.0
Detector 1 Queue (s)	0.0	0.0	0.0	0.0	0.0	0.0	0.0	0.0	0.0	0.0	0.0	0.0
Detector 1 Delay (s)	0.0	0.0	0.0	0.0	0.0	0.0	0.0	0.0	0.0	0.0	0.0	0.0
Turn Type	pm+pt	NA	Perm	pm+pt	NA	Perm	Prot	NA	Perm	Prot	NA	Perm
Protected Phases	7	4		3	8		5	2		1	6	
Permitted Phases	4		4	8		8			2			6
Detector Phase	7	4	4	3	8	8	5	2	2	1	6	6
Switch Phase												
Minimum Initial (s)	8.0	10.0	10.0	8.0	10.0	10.0	8.0	10.0	10.0	8.0	10.0	10.0
Minimum Split (s)	15.4	32.0	32.0	15.4	32.0	32.0	16.2	40.2	40.2	16.2	31.0	31.0
Total Split (s)	16.0	32.0	32.0	16.0	32.0	32.0	41.0	55.0	55.0	17.0	31.0	31.0

Lanes, Volumes, Timings
3: Tower Road & 104th Avenue



Lane Group	EBL	EBT	EBR	WBL	WBT	WBR	NBL	NBT	NBR	SBL	SBT	SBR
Total Split (%)	13.3%	26.7%	26.7%	13.3%	26.7%	26.7%	34.2%	45.8%	45.8%	14.2%	25.8%	25.8%
Maximum Green (s)	8.6	24.6	24.6	8.6	24.6	24.6	32.8	46.8	46.8	8.8	22.8	22.8
Yellow Time (s)	5.0	5.0	5.0	5.0	5.0	5.0	5.1	5.1	5.1	5.1	5.1	5.1
All-Red Time (s)	2.4	2.4	2.4	2.4	2.4	2.4	3.1	3.1	3.1	3.1	3.1	3.1
Lost Time Adjust (s)	0.0	0.0	0.0	0.0	0.0	0.0	0.0	0.0	0.0	0.0	0.0	0.0
Total Lost Time (s)	7.4	7.4	7.4	7.4	7.4	7.4	8.2	8.2	8.2	8.2	8.2	8.2
Lead/Lag	Lead	Lag	Lag	Lead	Lag	Lag	Lead	Lag	Lag	Lead	Lag	Lag
Lead-Lag Optimize?	Yes	Yes	Yes	Yes	Yes	Yes	Yes	Yes	Yes	Yes	Yes	Yes
Vehicle Extension (s)	2.0	2.0	2.0	2.0	2.0	2.0	2.0	5.0	5.0	2.0	5.0	5.0
Recall Mode	None	None	None	None	None	None	None	C-Min	C-Min	None	C-Min	C-Min
Act Effct Green (s)	24.3	19.1	19.1	20.3	12.2	12.2	26.9	69.5	69.5	8.0	40.8	40.8
Actuated g/C Ratio	0.20	0.16	0.16	0.17	0.10	0.10	0.22	0.58	0.58	0.07	0.34	0.34
v/c Ratio	0.55	0.23	0.71	0.16	0.45	0.06	0.84	0.44	0.04	0.11	0.46	0.15
Control Delay	39.9	39.2	23.1	36.1	52.9	0.3	54.9	17.0	0.1	55.0	34.1	0.5
Queue Delay	0.0	0.0	0.0	0.0	0.0	0.0	0.0	0.0	0.0	0.0	0.0	0.0
Total Delay	39.9	39.2	23.1	36.1	52.9	0.3	54.9	17.0	0.1	55.0	34.1	0.5
LOS	D	D	C	D	D	A	D	B	A	D	C	A
Approach Delay		29.9			46.8			32.1			29.1	
Approach LOS		C			D			C			C	

Intersection Summary

Area Type: Other
 Cycle Length: 120
 Actuated Cycle Length: 120
 Offset: 0 (0%), Referenced to phase 2:NBT and 6:SBT, Start of Yellow, Master Intersection
 Natural Cycle: 105
 Control Type: Actuated-Coordinated
 Maximum v/c Ratio: 0.84
 Intersection Signal Delay: 32.3
 Intersection LOS: C
 Intersection Capacity Utilization 71.4%
 ICU Level of Service C
 Analysis Period (min) 15

Splits and Phases: 3: Tower Road & 104th Avenue

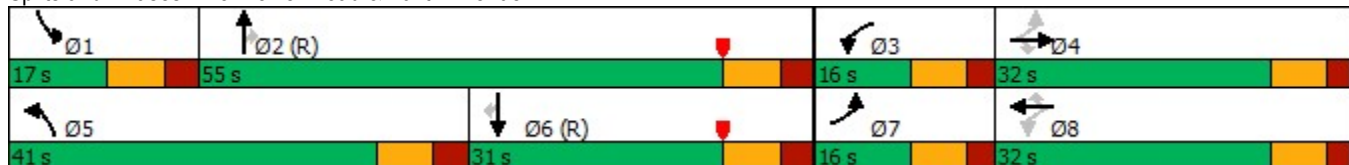

Queues
3: Tower Road & 104th Avenue



Lane Group	EBL	EBT	EBR	WBL	WBT	WBR	NBL	NBT	NBR	SBL	SBT	SBR
Lane Group Flow (vph)	135	185	448	37	231	22	647	896	38	13	553	109
v/c Ratio	0.55	0.23	0.71	0.16	0.45	0.06	0.84	0.44	0.04	0.11	0.46	0.15
Control Delay	39.9	39.2	23.1	36.1	52.9	0.3	54.9	17.0	0.1	55.0	34.1	0.5
Queue Delay	0.0	0.0	0.0	0.0	0.0	0.0	0.0	0.0	0.0	0.0	0.0	0.0
Total Delay	39.9	39.2	23.1	36.1	52.9	0.3	54.9	17.0	0.1	55.0	34.1	0.5
Queue Length 50th (ft)	92	50	158	23	64	0	247	156	0	10	169	0
Queue Length 95th (ft)	130	68	253	41	81	0	297	336	0	26	263	0
Internal Link Dist (ft)		1030			760			540			920	
Turn Bay Length (ft)	420			475		300	160			250		
Base Capacity (vph)	245	1078	688	245	1042	534	938	2048	992	129	1204	707
Starvation Cap Reductn	0	0	0	0	0	0	0	0	0	0	0	0
Spillback Cap Reductn	0	0	0	0	0	0	0	0	0	0	0	0
Storage Cap Reductn	0	0	0	0	0	0	0	0	0	0	0	0
Reduced v/c Ratio	0.55	0.17	0.65	0.15	0.22	0.04	0.69	0.44	0.04	0.10	0.46	0.15

Intersection Summary

HCM 6th Signalized Intersection Summary
3: Tower Road & 104th Avenue

JR Engineering
10/03/2023



Movement	EBL	EBT	EBR	WBL	WBT	WBR	NBL	NBT	NBR	SBL	SBT	SBR
Lane Configurations	↘	↑↑↑	↗	↘	↑↑↑	↗	↘↗	↑↑	↗	↘	↑↑	↗
Traffic Volume (veh/h)	112	155	394	29	201	17	595	824	30	10	487	87
Future Volume (veh/h)	112	155	394	29	201	17	595	824	30	10	487	87
Initial Q (Qb), veh	0	0	0	0	0	0	0	0	0	0	0	0
Ped-Bike Adj(A_pbT)	1.00		1.00	1.00		1.00	1.00		1.00	1.00		1.00
Parking Bus, Adj	1.00	1.00	1.00	1.00	1.00	1.00	1.00	1.00	1.00	1.00	1.00	1.00
Work Zone On Approach		No			No			No			No	
Adj Sat Flow, veh/h/ln	1870	1870	1870	1870	1870	1870	1870	1870	1870	1870	1870	1870
Adj Flow Rate, veh/h	135	185	0	37	231	0	647	896	0	13	553	0
Peak Hour Factor	0.83	0.84	0.88	0.78	0.87	0.78	0.92	0.92	0.78	0.78	0.88	0.80
Percent Heavy Veh, %	2	2	2	2	2	2	2	2	2	2	2	2
Cap, veh/h	234	550		231	426		724	1996		42	1334	
Arrive On Green	0.02	0.04	0.00	0.05	0.08	0.00	0.21	0.56	0.00	0.02	0.38	0.00
Sat Flow, veh/h	1781	5106	1585	1781	5106	1585	3456	3554	1585	1781	3554	1585
Grp Volume(v), veh/h	135	185	0	37	231	0	647	896	0	13	553	0
Grp Sat Flow(s),veh/h/ln	1781	1702	1585	1781	1702	1585	1728	1777	1585	1781	1777	1585
Q Serve(g_s), s	8.3	4.2	0.0	2.2	5.2	0.0	21.8	17.7	0.0	0.9	13.8	0.0
Cycle Q Clear(g_c), s	8.3	4.2	0.0	2.2	5.2	0.0	21.8	17.7	0.0	0.9	13.8	0.0
Prop In Lane	1.00		1.00	1.00		1.00	1.00		1.00	1.00		1.00
Lane Grp Cap(c), veh/h	234	550		231	426		724	1996		42	1334	
V/C Ratio(X)	0.58	0.34		0.16	0.54		0.89	0.45		0.31	0.41	
Avail Cap(c_a), veh/h	234	1047		274	1047		945	1996		131	1334	
HCM Platoon Ratio	0.33	0.33	0.33	1.00	1.00	1.00	1.00	1.00	1.00	1.00	1.00	1.00
Upstream Filter(I)	1.00	1.00	0.00	1.00	1.00	0.00	1.00	1.00	0.00	1.00	1.00	0.00
Uniform Delay (d), s/veh	48.9	53.7	0.0	46.3	52.8	0.0	46.1	15.4	0.0	57.6	27.7	0.0
Incr Delay (d2), s/veh	2.3	0.1	0.0	0.1	0.4	0.0	7.6	0.7	0.0	1.6	1.0	0.0
Initial Q Delay(d3),s/veh	0.0	0.0	0.0	0.0	0.0	0.0	0.0	0.0	0.0	0.0	0.0	0.0
%ile BackOfQ(50%),veh/ln	4.0	1.9	0.0	1.0	2.2	0.0	10.1	7.2	0.0	0.4	6.1	0.0
Unsig. Movement Delay, s/veh												
LnGrp Delay(d),s/veh	51.2	53.8	0.0	46.4	53.2	0.0	53.7	16.2	0.0	59.2	28.7	0.0
LnGrp LOS	D	D		D	D		D	B		E	C	
Approach Vol, veh/h		320			268			1543			566	
Approach Delay, s/veh		52.7			52.3			31.9			29.4	
Approach LOS		D			D			C			C	
Timer - Assigned Phs	1	2	3	4	5	6	7	8				
Phs Duration (G+Y+Rc), s	11.0	75.6	13.1	20.3	33.4	53.2	16.0	17.4				
Change Period (Y+Rc), s	8.2	8.2	7.4	7.4	8.2	8.2	7.4	7.4				
Max Green Setting (Gmax), s	8.8	46.8	8.6	24.6	32.8	22.8	8.6	24.6				
Max Q Clear Time (g_c+I1), s	2.9	19.7	4.2	6.2	23.8	15.8	10.3	7.2				
Green Ext Time (p_c), s	0.0	9.5	0.0	0.4	1.3	2.5	0.0	0.5				

Intersection Summary

HCM 6th Ctrl Delay	35.9
HCM 6th LOS	D

Notes

User approved pedestrian interval to be less than phase max green.
Unsignalized Delay for [NBR, EBR, WBR, SBR] is excluded from calculations of the approach delay and intersection delay.

Lanes, Volumes, Timings
4: Tower Road & Private Access



Lane Group	EBL	EBR	NBL	NBT	SBT	SBR
Lane Configurations		↗		↑↑	↑↑↑	
Traffic Volume (vph)	0	11	0	0	0	14
Future Volume (vph)	0	11	0	0	0	14
Ideal Flow (vphpl)	1900	1900	1900	1900	1900	1900
Lane Util. Factor	1.00	1.00	1.00	0.95	0.91	0.91
Fr _t		0.865			0.850	
Fl _t Protected						
Satd. Flow (prot)	0	1611	0	3539	4322	0
Fl _t Permitted						
Satd. Flow (perm)	0	1611	0	3539	4322	0
Link Speed (mph)	30			50	30	
Link Distance (ft)	345			530	620	
Travel Time (s)	7.8			7.2	14.1	
Peak Hour Factor	0.78	0.78	0.78	0.78	0.78	0.78
Adj. Flow (vph)	0	14	0	0	0	18
Shared Lane Traffic (%)						
Lane Group Flow (vph)	0	14	0	0	18	0
Enter Blocked Intersection	No	No	No	No	No	No
Lane Alignment	Left	Right	Left	Left	Left	Right
Median Width(ft)	0			24	24	
Link Offset(ft)	0			0	0	
Crosswalk Width(ft)	16			16	16	
Two way Left Turn Lane						
Headway Factor	1.00	1.00	1.00	1.00	1.00	1.00
Turning Speed (mph)	15	9	15			9
Sign Control	Stop			Free	Free	

Intersection Summary

Area Type:	Other
Control Type:	Unsignalized
Intersection Capacity Utilization	13.3%
Analysis Period (min)	15
	ICU Level of Service A

Intersection						
Int Delay, s/veh	4					
Movement	EBL	EBR	NBL	NBT	SBT	SBR
Lane Configurations		↗		↑↑	↑↑↑	
Traffic Vol, veh/h	0	11	0	0	0	14
Future Vol, veh/h	0	11	0	0	0	14
Conflicting Peds, #/hr	0	0	0	0	0	0
Sign Control	Stop	Stop	Free	Free	Free	Free
RT Channelized	-	None	-	None	-	None
Storage Length	-	0	-	-	-	-
Veh in Median Storage, #	0	-	-	0	0	-
Grade, %	0	-	-	0	0	-
Peak Hour Factor	78	78	78	78	78	78
Heavy Vehicles, %	2	2	2	2	2	2
Mvmt Flow	0	14	0	0	0	18

Major/Minor	Minor2	Major1	Major2
Conflicting Flow All	-	9	0
Stage 1	-	-	-
Stage 2	-	-	-
Critical Hdwy	-	7.14	-
Critical Hdwy Stg 1	-	-	-
Critical Hdwy Stg 2	-	-	-
Follow-up Hdwy	-	3.92	-
Pot Cap-1 Maneuver	0	907	0
Stage 1	0	-	0
Stage 2	0	-	0
Platoon blocked, %			
Mov Cap-1 Maneuver	-	907	-
Mov Cap-2 Maneuver	-	-	-
Stage 1	-	-	-
Stage 2	-	-	-

Approach	EB	NB	SB
HCM Control Delay, s	9	0	0
HCM LOS	A		

Minor Lane/Major Mvmt	NBT EBLn1	SBT	SBR
Capacity (veh/h)	- 907	-	-
HCM Lane V/C Ratio	- 0.016	-	-
HCM Control Delay (s)	- 9	-	-
HCM Lane LOS	- A	-	-
HCM 95th %tile Q(veh)	- 0	-	-

Lanes, Volumes, Timings
5: 103rd Avenue & Tower Road

JR Engineering
10/03/2023



Lane Group	EBL	EBT	EBR	WBL	WBT	WBR	NBL	NBT	NBR	SBL	SBT	SBR
Lane Configurations	↖	↗		↖	↗		↖	↕	↗	↖	↕	↗
Traffic Volume (vph)	11	1	34	16	1	65	125	1319	13	69	942	8
Future Volume (vph)	11	1	34	16	1	65	125	1319	13	69	942	8
Ideal Flow (vphpl)	1900	1900	1900	1900	1900	1900	1900	1900	1900	1900	1900	1900
Storage Length (ft)	45		0	100		0	440		185	130		0
Storage Lanes	1		0	1		0	1		0	1		0
Taper Length (ft)	25			25			25			25		
Lane Util. Factor	1.00	1.00	1.00	1.00	1.00	1.00	1.00	0.95	0.95	1.00	0.91	0.91
Frt		0.853			0.852			0.998			0.999	
Flt Protected	0.950			0.950			0.950			0.950		
Satd. Flow (prot)	1770	1589	0	1770	1587	0	1770	3532	0	1770	5080	0
Flt Permitted	0.950			0.950			0.950			0.950		
Satd. Flow (perm)	1770	1589	0	1770	1587	0	1770	3532	0	1770	5080	0
Link Speed (mph)		30			30			50			30	
Link Distance (ft)		875			708			356			530	
Travel Time (s)		19.9			16.1			4.9			12.0	
Peak Hour Factor	0.78	0.78	0.78	0.78	0.78	0.79	0.84	0.93	0.78	0.79	0.92	0.78
Adj. Flow (vph)	14	1	44	21	1	82	149	1418	17	87	1024	10
Shared Lane Traffic (%)												
Lane Group Flow (vph)	14	45	0	21	83	0	149	1435	0	87	1034	0
Enter Blocked Intersection	No	No	No	No	No	No	No	No	No	No	No	No
Lane Alignment	Left	Left	Right	Left	Left	Right	Left	Left	Right	Left	Left	Right
Median Width(ft)		12			12			12			12	
Link Offset(ft)		0			0			0			0	
Crosswalk Width(ft)		16			16			16			16	
Two way Left Turn Lane												
Headway Factor	1.00	1.00	1.00	1.00	1.00	1.00	1.00	1.00	1.00	1.00	1.00	1.00
Turning Speed (mph)	60		60	60		60	60		60	60		60
Sign Control		Stop			Stop			Free			Free	

Intersection Summary

Area Type:	Other
Control Type:	Unsignalized
Intersection Capacity Utilization	58.2%
ICU Level of Service	B
Analysis Period (min)	15

Intersection												
Int Delay, s/veh	11.7											
Movement	EBL	EBT	EBR	WBL	WBT	WBR	NBL	NBT	NBR	SBL	SBT	SBR
Lane Configurations	↖	↗		↖	↗		↖	↗		↖	↗	↖
Traffic Vol, veh/h	11	1	34	16	1	65	125	1319	13	69	942	8
Future Vol, veh/h	11	1	34	16	1	65	125	1319	13	69	942	8
Conflicting Peds, #/hr	0	0	0	0	0	0	0	0	0	0	0	0
Sign Control	Stop	Stop	Stop	Stop	Stop	Stop	Free	Free	Free	Free	Free	Free
RT Channelized	-	-	None	-	-	None	-	-	None	-	-	None
Storage Length	45	-	-	100	-	-	440	-	-	130	-	-
Veh in Median Storage, #	-	0	-	-	0	-	-	0	-	-	0	-
Grade, %	-	0	-	-	0	-	-	0	-	-	0	-
Peak Hour Factor	78	78	78	78	78	79	84	93	78	79	92	78
Heavy Vehicles, %	2	2	2	2	2	2	2	2	2	2	2	2
Mvmt Flow	14	1	44	21	1	82	149	1418	17	87	1024	10

Major/Minor	Minor2		Minor1		Major1		Major2					
Conflicting Flow All	2211	2936	517	2309	2933	718	1034	0	0	1435	0	0
Stage 1	1203	1203	-	1725	1725	-	-	-	-	-	-	-
Stage 2	1008	1733	-	584	1208	-	-	-	-	-	-	-
Critical Hdwy	6.99	6.54	7.14	6.99	6.54	6.94	5.34	-	-	4.14	-	-
Critical Hdwy Stg 1	7.34	5.54	-	6.54	5.54	-	-	-	-	-	-	-
Critical Hdwy Stg 2	6.54	5.54	-	6.74	5.54	-	-	-	-	-	-	-
Follow-up Hdwy	3.67	4.02	3.92	3.67	4.02	3.32	3.12	-	-	2.22	-	-
Pot Cap-1 Maneuver	34	15	431	29	15	371	377	-	-	469	-	-
Stage 1	146	256	-	91	142	-	-	-	-	-	-	-
Stage 2	252	141	-	436	254	-	-	-	-	-	-	-
Platoon blocked, %								-	-	-	-	-
Mov Cap-1 Maneuver	~ 14	7	431	~ 14	7	371	377	-	-	469	-	-
Mov Cap-2 Maneuver	~ 14	7	-	~ 14	7	-	-	-	-	-	-	-
Stage 1	88	208	-	55	86	-	-	-	-	-	-	-
Stage 2	117	85	-	317	207	-	-	-	-	-	-	-

























Approach	EB	WB	NB	SB
HCM Control Delay, s	172.6	183.3	1.9	1.1
HCM LOS	F	F		

Minor Lane/Major Mvmt	NBL	NBT	NBR	EBLn1	EBLn2	WBLn1	WBLn2	SBL	SBT	SBR
Capacity (veh/h)	377	-	-	14	158	14	206	469	-	-
HCM Lane V/C Ratio	0.395	-	-	1.007	0.284	1.465	0.406	0.186	-	-
HCM Control Delay (s)	20.6	-	-	\$ 605.2	36.6	\$ 791.7	33.9	14.4	-	-
HCM Lane LOS	C	-	-	F	E	F	D	B	-	-
HCM 95th %tile Q(veh)	1.8	-	-	2.3	1.1	3.2	1.8	0.7	-	-

Notes
 ~: Volume exceeds capacity \$: Delay exceeds 300s +: Computation Not Defined *: All major volume in platoon

Lanes, Volumes, Timings
1: Walden Street & 104th Avenue

09/21/2023

												
Lane Group	EBL	EBT	EBR	WBL	WBT	WBR	NBL	NBT	NBR	SBL	SBT	SBR
Lane Configurations												
Traffic Volume (vph)	135	1448	100	21	722	139	163	44	83	338	41	144
Future Volume (vph)	135	1448	100	21	722	139	163	44	83	338	41	144
Ideal Flow (vphpl)	1900	1900	1900	1900	1900	1900	1900	1900	1900	1900	1900	1900
Storage Length (ft)	400		230	0		250	230		230	210		140
Storage Lanes	1		1	1		1	1		1	1		1
Taper Length (ft)	25			25			25			25		
Lane Util. Factor	1.00	0.95	1.00	1.00	0.95	1.00	1.00	1.00	1.00	1.00	1.00	1.00
Frt			0.850			0.850			0.850			0.850
Flt Protected	0.950			0.950			0.950			0.950		
Satd. Flow (prot)	1770	3539	1583	1770	3539	1583	1770	1863	1583	1770	1863	1583
Flt Permitted	0.226			0.081			0.722			0.442		
Satd. Flow (perm)	421	3539	1583	151	3539	1583	1345	1863	1583	823	1863	1583
Right Turn on Red			Yes			Yes			Yes			Yes
Satd. Flow (RTOR)			218			218			227			173
Link Speed (mph)		45			45			30				30
Link Distance (ft)		149			767			699				204
Travel Time (s)		2.3			11.6			15.9				4.6
Peak Hour Factor	0.84	0.93	0.83	0.78	0.92	0.84	0.84	0.78	0.80	0.88	0.78	0.83
Adj. Flow (vph)	161	1557	120	27	785	165	194	56	104	384	53	173
Shared Lane Traffic (%)												
Lane Group Flow (vph)	161	1557	120	27	785	165	194	56	104	384	53	173
Enter Blocked Intersection	No	No	No	No	No	No	No	No	No	No	No	No
Lane Alignment	Left	Left	Right	Left	Left	Right	Left	Left	Right	Left	Left	Right
Median Width(ft)		12			12			12				12
Link Offset(ft)		0			0			0				0
Crosswalk Width(ft)		16			16			16				16
Two way Left Turn Lane												
Headway Factor	1.00	1.00	1.00	1.00	1.00	1.00	1.00	1.00	1.00	1.00	1.00	1.00
Turning Speed (mph)	15		9	15		9	15		9	15		9
Number of Detectors	1	2	1	1	2	1	1	2	1	1	2	1
Detector Template	Left	Thru	Right	Left	Thru	Right	Left	Thru	Right	Left	Thru	Right
Leading Detector (ft)	20	100	20	20	100	20	20	100	20	20	100	20
Trailing Detector (ft)	0	0	0	0	0	0	0	0	0	0	0	0
Detector 1 Position(ft)	0	0	0	0	0	0	0	0	0	0	0	0
Detector 1 Size(ft)	20	6	20	20	6	20	20	6	20	20	6	20
Detector 1 Type	Cl+Ex	Cl+Ex	Cl+Ex	Cl+Ex	Cl+Ex	Cl+Ex	Cl+Ex	Cl+Ex	Cl+Ex	Cl+Ex	Cl+Ex	Cl+Ex
Detector 1 Channel												
Detector 1 Extend (s)	0.0	0.0	0.0	0.0	0.0	0.0	0.0	0.0	0.0	0.0	0.0	0.0
Detector 1 Queue (s)	0.0	0.0	0.0	0.0	0.0	0.0	0.0	0.0	0.0	0.0	0.0	0.0
Detector 1 Delay (s)	0.0	0.0	0.0	0.0	0.0	0.0	0.0	0.0	0.0	0.0	0.0	0.0
Detector 2 Position(ft)		94			94			94				94
Detector 2 Size(ft)		6			6			6				6
Detector 2 Type		Cl+Ex			Cl+Ex			Cl+Ex				Cl+Ex
Detector 2 Channel												
Detector 2 Extend (s)		0.0			0.0			0.0				0.0
Turn Type	pm+pt	NA	Perm	pm+pt	NA	Perm	pm+pt	NA	Perm	pm+pt	NA	Perm
Protected Phases	5	2		1	6		3	8		7	4	
Permitted Phases	2		2	6		6	8		8	4		4

Lanes, Volumes, Timings
1: Walden Street & 104th Avenue

09/21/2023

Lane Group	EBL	EBT	EBR	WBL	WBT	WBR	NBL	NBT	NBR	SBL	SBT	SBR
Detector Phase	5	2	2	1	6	6	3	8	8	7	4	4
Switch Phase												
Minimum Initial (s)	5.0	10.0	10.0	5.0	10.0	10.0	8.0	10.0	10.0	8.0	10.0	10.0
Minimum Split (s)	12.5	17.5	17.5	12.5	17.5	17.5	14.5	16.5	16.5	14.5	16.5	16.5
Total Split (s)	17.8	53.3	53.3	12.5	48.0	48.0	21.0	25.5	25.5	28.7	33.2	33.2
Total Split (%)	14.8%	44.4%	44.4%	10.4%	40.0%	40.0%	17.5%	21.3%	21.3%	23.9%	27.7%	27.7%
Maximum Green (s)	10.3	45.8	45.8	5.0	40.5	40.5	14.5	19.0	19.0	22.2	26.7	26.7
Yellow Time (s)	5.3	5.3	5.3	5.3	5.3	5.3	3.8	3.8	3.8	3.8	3.8	3.8
All-Red Time (s)	2.2	2.2	2.2	2.2	2.2	2.2	2.7	2.7	2.7	2.7	2.7	2.7
Lost Time Adjust (s)	0.0	0.0	0.0	0.0	0.0	0.0	0.0	0.0	0.0	0.0	0.0	0.0
Total Lost Time (s)	7.5	7.5	7.5	7.5	7.5	7.5	6.5	6.5	6.5	6.5	6.5	6.5
Lead/Lag	Lead	Lag	Lag	Lead	Lag	Lag	Lead	Lag	Lag	Lead	Lag	Lag
Lead-Lag Optimize?	Yes	Yes	Yes	Yes	Yes	Yes	Yes	Yes	Yes	Yes	Yes	Yes
Vehicle Extension (s)	3.0	5.0	5.0	3.0	5.0	5.0	2.0	2.0	2.0	2.0	2.0	2.0
Recall Mode	None	C-Max	C-Max	None	C-Max	C-Max	None	None	None	None	None	None
Act Effct Green (s)	66.4	59.0	59.0	55.5	49.2	49.2	23.3	10.3	10.3	38.5	18.9	18.9
Actuated g/C Ratio	0.55	0.49	0.49	0.46	0.41	0.41	0.19	0.09	0.09	0.32	0.16	0.16
v/c Ratio	0.45	0.90	0.14	0.17	0.54	0.21	0.63	0.35	0.30	0.88	0.18	0.44
Control Delay	17.2	37.3	0.3	15.7	29.2	1.7	42.2	58.1	2.3	58.7	46.1	10.3
Queue Delay	0.0	0.0	0.0	0.0	0.0	0.0	0.0	0.0	0.0	0.0	0.0	0.0
Total Delay	17.2	37.3	0.3	15.7	29.2	1.7	42.2	58.1	2.3	58.7	46.1	10.3
LOS	B	D	A	B	C	A	D	E	A	E	D	B
Approach Delay		33.1			24.2			33.0			43.9	
Approach LOS		C			C			C			D	

Intersection Summary

Area Type:	Other
Cycle Length:	120
Actuated Cycle Length:	120
Offset:	0 (0%), Referenced to phase 2:EBTL and 6:WBTL, Start of Yellow
Natural Cycle:	100
Control Type:	Actuated-Coordinated
Maximum v/c Ratio:	0.90
Intersection Signal Delay:	32.5
Intersection LOS:	C
Intersection Capacity Utilization:	87.5%
ICU Level of Service:	E
Analysis Period (min):	15

Splits and Phases: 1: Walden Street & 104th Avenue



Queues

1: Walden Street & 104th Avenue

09/21/2023

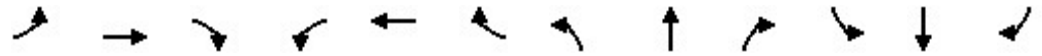

Lane Group	EBL	EBT	EBR	WBL	WBT	WBR	NBL	NBT	NBR	SBL	SBT	SBR
Lane Group Flow (vph)	161	1557	120	27	785	165	194	56	104	384	53	173
v/c Ratio	0.45	0.90	0.14	0.17	0.54	0.21	0.63	0.35	0.30	0.88	0.18	0.44
Control Delay	17.2	37.3	0.3	15.7	29.2	1.7	42.2	58.1	2.3	58.7	46.1	10.3
Queue Delay	0.0	0.0	0.0	0.0	0.0	0.0	0.0	0.0	0.0	0.0	0.0	0.0
Total Delay	17.2	37.3	0.3	15.7	29.2	1.7	42.2	58.1	2.3	58.7	46.1	10.3
Queue Length 50th (ft)	57	615	0	9	239	0	114	42	0	257	36	0
Queue Length 95th (ft)	89	#822	0	20	323	9	162	72	0	#399	65	48
Internal Link Dist (ft)		69			687			619			124	
Turn Bay Length (ft)	400		230			250	230		230	210		140
Base Capacity (vph)	362	1738	888	155	1451	777	328	294	441	438	414	486
Starvation Cap Reductn	0	0	0	0	0	0	0	0	0	0	0	0
Spillback Cap Reductn	0	0	0	0	0	0	0	0	0	0	0	0
Storage Cap Reductn	0	0	0	0	0	0	0	0	0	0	0	0
Reduced v/c Ratio	0.44	0.90	0.14	0.17	0.54	0.21	0.59	0.19	0.24	0.88	0.13	0.36

























Intersection Summary

95th percentile volume exceeds capacity, queue may be longer.
 Queue shown is maximum after two cycles.

HCM 6th Signalized Intersection Summary

1: Walden Street & 104th Avenue

09/21/2023

												
Movement	EBL	EBT	EBR	WBL	WBT	WBR	NBL	NBT	NBR	SBL	SBT	SBR
Lane Configurations												
Traffic Volume (veh/h)	135	1448	100	21	722	139	163	44	83	338	41	144
Future Volume (veh/h)	135	1448	100	21	722	139	163	44	83	338	41	144
Initial Q (Qb), veh	0	0	0	0	0	0	0	0	0	0	0	0
Ped-Bike Adj(A_pbT)	1.00		1.00	1.00		1.00	1.00		1.00	1.00		1.00
Parking Bus, Adj	1.00	1.00	1.00	1.00	1.00	1.00	1.00	1.00	1.00	1.00	1.00	1.00
Work Zone On Approach		No			No			No			No	
Adj Sat Flow, veh/h/ln	1870	1870	1870	1870	1870	1870	1870	1870	1870	1870	1870	1870
Adj Flow Rate, veh/h	161	1557	120	27	785	165	194	56	104	384	53	173
Peak Hour Factor	0.84	0.93	0.83	0.78	0.92	0.84	0.84	0.78	0.80	0.88	0.78	0.83
Percent Heavy Veh, %	2	2	2	2	2	2	2	2	2	2	2	2
Cap, veh/h	339	1683	751	123	1533	684	361	156	132	457	287	244
Arrive On Green	0.07	0.47	0.47	0.02	0.43	0.43	0.11	0.08	0.08	0.19	0.15	0.15
Sat Flow, veh/h	1781	3554	1585	1781	3554	1585	1781	1870	1585	1781	1870	1585
Grp Volume(v), veh/h	161	1557	120	27	785	165	194	56	104	384	53	173
Grp Sat Flow(s),veh/h/ln	1781	1777	1585	1781	1777	1585	1781	1870	1585	1781	1870	1585
Q Serve(g_s), s	6.0	49.3	5.2	1.0	19.3	7.9	11.8	3.4	7.7	22.2	3.0	12.4
Cycle Q Clear(g_c), s	6.0	49.3	5.2	1.0	19.3	7.9	11.8	3.4	7.7	22.2	3.0	12.4
Prop In Lane	1.00		1.00	1.00		1.00	1.00		1.00	1.00		1.00
Lane Grp Cap(c), veh/h	339	1683	751	123	1533	684	361	156	132	457	287	244
V/C Ratio(X)	0.48	0.93	0.16	0.22	0.51	0.24	0.54	0.36	0.79	0.84	0.18	0.71
Avail Cap(c_a), veh/h	372	1683	751	153	1533	684	371	296	251	457	416	353
HCM Platoon Ratio	1.00	1.00	1.00	1.00	1.00	1.00	1.00	1.00	1.00	1.00	1.00	1.00
Upstream Filter(I)	1.00	1.00	1.00	1.00	1.00	1.00	1.00	1.00	1.00	1.00	1.00	1.00
Uniform Delay (d), s/veh	18.7	29.6	18.0	27.0	24.9	21.7	43.3	52.0	54.0	39.6	44.2	48.2
Incr Delay (d2), s/veh	1.0	10.2	0.5	0.9	1.2	0.8	0.7	0.5	3.9	12.5	0.1	1.4
Initial Q Delay(d3),s/veh	0.0	0.0	0.0	0.0	0.0	0.0	0.0	0.0	0.0	0.0	0.0	0.0
%ile BackOfQ(50%),veh/ln	2.4	21.8	2.0	0.4	8.0	3.1	5.3	1.6	3.2	11.8	1.4	5.0
Unsig. Movement Delay, s/veh												
LnGrp Delay(d),s/veh	19.8	39.7	18.4	27.9	26.1	22.5	44.0	52.5	57.8	52.1	44.3	49.7
LnGrp LOS	B	D	B	C	C	C	D	D	E	D	D	D
Approach Vol, veh/h		1838			977			354				610
Approach Delay, s/veh		36.6			25.6			49.4				50.7
Approach LOS		D			C			D				D
Timer - Assigned Phs	1	2	3	4	5	6	7	8				
Phs Duration (G+Y+Rc), s	10.5	64.3	20.3	24.9	15.5	59.3	28.7	16.5				
Change Period (Y+Rc), s	* 7.5	* 7.5	6.5	6.5	* 7.5	* 7.5	6.5	6.5				
Max Green Setting (Gmax), s	* 5	* 46	14.5	26.7	* 10	* 41	22.2	19.0				
Max Q Clear Time (g_c+I1), s	3.0	51.3	13.8	14.4	8.0	21.3	24.2	9.7				
Green Ext Time (p_c), s	0.0	0.0	0.0	0.4	0.1	9.5	0.0	0.2				
Intersection Summary												
HCM 6th Ctrl Delay												37.2
HCM 6th LOS												D
Notes												
* HCM 6th computational engine requires equal clearance times for the phases crossing the barrier.												

Lanes, Volumes, Timings
2: Yampa Street & 104th Avenue

09/21/2023

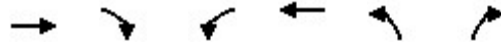

Lane Group	EBT	EBR	WBL	WBT	NBL	NBR
Lane Configurations	↑↑↑	↑	↓	↑↑↑		↓
Traffic Volume (vph)	1864	19	15	903	0	19
Future Volume (vph)	1864	19	15	903	0	19
Ideal Flow (vphpl)	1900	1900	1900	1900	1900	1900
Storage Length (ft)		50	50		0	0
Storage Lanes		1	1		0	1
Taper Length (ft)			25		25	
Lane Util. Factor	0.91	1.00	1.00	0.91	1.00	1.00
Frt		0.850				0.865
Flt Protected			0.950			
Satd. Flow (prot)	5085	1583	1770	5085	0	1611
Flt Permitted			0.950			
Satd. Flow (perm)	5085	1583	1770	5085	0	1611
Link Speed (mph)	35			45	30	
Link Distance (ft)	767			1110	440	
Travel Time (s)	14.9			16.8	10.0	
Peak Hour Factor	0.93	0.78	0.78	0.92	0.78	0.78
Adj. Flow (vph)	2004	24	19	982	0	24
Shared Lane Traffic (%)						
Lane Group Flow (vph)	2004	24	19	982	0	24
Enter Blocked Intersection	No	No	No	No	No	No
Lane Alignment	Left	Right	Left	Left	Left	Right
Median Width(ft)	24			24	0	
Link Offset(ft)	0			0	0	
Crosswalk Width(ft)	16			16	16	
Two way Left Turn Lane						
Headway Factor	1.00	1.00	1.00	1.00	1.00	1.00
Turning Speed (mph)		9	15		15	9
Sign Control	Free			Free	Stop	

Intersection Summary

Area Type:	Other
Control Type:	Unsignalized
Intersection Capacity Utilization	46.0%
	ICU Level of Service A
Analysis Period (min)	15

HCM 6th TWSC
2: Yampa Street & 104th Avenue

09/21/2023

Intersection						
Int Delay, s/veh	0.5					
Movement	EBT	EBR	WBL	WBT	NBL	NBR
Lane Configurations	↑↑↑	↑	↑	↑↑↑		↑
Traffic Vol, veh/h	1864	19	15	903	0	19
Future Vol, veh/h	1864	19	15	903	0	19
Conflicting Peds, #/hr	0	0	0	0	0	0
Sign Control	Free	Free	Free	Free	Stop	Stop
RT Channelized	-	None	-	None	-	None
Storage Length	-	50	50	-	-	0
Veh in Median Storage, #	0	-	-	0	0	-
Grade, %	0	-	-	0	0	-
Peak Hour Factor	93	78	78	92	78	78
Heavy Vehicles, %	2	2	2	2	2	2
Mvmt Flow	2004	24	19	982	0	24

Major/Minor	Major1	Major2	Minor1
Conflicting Flow All	0	0	1002
Stage 1	-	-	-
Stage 2	-	-	-
Critical Hdwy	-	5.34	7.14
Critical Hdwy Stg 1	-	-	-
Critical Hdwy Stg 2	-	-	-
Follow-up Hdwy	-	3.12	3.92
Pot Cap-1 Maneuver	-	121	207
Stage 1	-	-	0
Stage 2	-	-	0
Platoon blocked, %	-	-	-
Mov Cap-1 Maneuver	-	121	207
Mov Cap-2 Maneuver	-	-	-
Stage 1	-	-	-
Stage 2	-	-	-

Approach	EB	WB	NB
HCM Control Delay, s	0	0.8	24.7
HCM LOS			C

Minor Lane/Major Mvmt	NBLn1	EBT	EBR	WBL	WBT
Capacity (veh/h)	207	-	-	121	-
HCM Lane V/C Ratio	0.118	-	-	0.159	-
HCM Control Delay (s)	24.7	-	-	40.3	-
HCM Lane LOS	C	-	-	E	-
HCM 95th %tile Q(veh)	0.4	-	-	0.5	-

Lanes, Volumes, Timings
3: Tower Road & 104th Avenue

09/21/2023



Lane Group	EBL	EBT	EBR	WBL	WBT	WBR	NBL	NBT	NBR	SBL	SBT	SBR
Lane Configurations	↖↖	↑↑↑	↗	↖↖	↑↑↑	↗	↖↖	↑↑↑	↗	↖↖	↑↑↑	↗
Traffic Volume (vph)	190	548	884	46	181	10	444	867	89	22	1158	149
Future Volume (vph)	190	548	884	46	181	10	444	867	89	22	1158	149
Ideal Flow (vphp)	1900	1900	1900	1900	1900	1900	1900	1900	1900	1900	1900	1900
Storage Length (ft)	350		590	330		440	320		290	290		190
Storage Lanes	2		1	2		1	2		1	2		1
Taper Length (ft)	25			25			25			25		
Lane Util. Factor	0.97	0.91	1.00	0.97	0.91	1.00	0.97	0.91	1.00	0.97	0.91	1.00
Frt			0.850			0.850			0.850			0.850
Flt Protected	0.950			0.950			0.950			0.950		
Satd. Flow (prot)	3433	5085	1583	3433	5085	1583	3433	5085	1583	3433	5085	1583
Flt Permitted	0.950			0.950			0.950			0.950		
Satd. Flow (perm)	3433	5085	1583	3433	5085	1583	3433	5085	1583	3433	5085	1583
Right Turn on Red			Yes			Yes			Yes			Yes
Satd. Flow (RTOR)			299			268			260			260
Link Speed (mph)		45		45			50			50		
Link Distance (ft)		1110		840			620			1000		
Travel Time (s)		16.8		12.7			8.5			13.6		
Peak Hour Factor	0.87	0.92	0.92	0.78	0.87	0.78	0.88	0.92	0.80	0.78	0.93	0.84
Adj. Flow (vph)	218	596	961	59	208	13	505	942	111	28	1245	177
Shared Lane Traffic (%)												
Lane Group Flow (vph)	218	596	961	59	208	13	505	942	111	28	1245	177
Enter Blocked Intersection	No	No	No	No	No	No	No	No	No	No	No	No
Lane Alignment	Left	Left	Right	Left	Left	Right	Left	Left	Right	Left	Left	Right
Median Width(ft)		24		24			24			24		24
Link Offset(ft)		0		0			0			0		0
Crosswalk Width(ft)		16		16			16			16		16
Two way Left Turn Lane												
Headway Factor	1.00	1.00	1.00	1.00	1.00	1.00	1.00	1.00	1.00	1.00	1.00	1.00
Turning Speed (mph)	15		9	15		9	15		9	15		9
Number of Detectors	1	1	1	1	1	1	1	1	1	1	1	1
Detector Template	Left	Thru	Right	Left	Thru	Right	Left	Thru	Right	Left	Thru	Right
Leading Detector (ft)	40	40	40	40	40	40	40	40	40	40	40	40
Trailing Detector (ft)	0	0	0	0	0	0	0	0	0	0	0	0
Detector 1 Position(ft)	0	0	0	0	0	0	0	0	0	0	0	0
Detector 1 Size(ft)	40	40	40	40	40	40	40	40	40	40	40	40
Detector 1 Type	Cl+Ex	Cl+Ex	Cl+Ex	Cl+Ex	Cl+Ex	Cl+Ex	Cl+Ex	Cl+Ex	Cl+Ex	Cl+Ex	Cl+Ex	Cl+Ex
Detector 1 Channel												
Detector 1 Extend (s)	0.0	0.0	0.0	0.0	0.0	0.0	0.0	0.0	0.0	0.0	0.0	0.0
Detector 1 Queue (s)	0.0	0.0	0.0	0.0	0.0	0.0	0.0	0.0	0.0	0.0	0.0	0.0
Detector 1 Delay (s)	0.0	0.0	0.0	0.0	0.0	0.0	0.0	0.0	0.0	0.0	0.0	0.0
Turn Type	Prot	NA	Perm	Prot	NA	Perm	Prot	NA	Perm	Prot	NA	Perm
Protected Phases	7	4		3	8		5	2		1	6	
Permitted Phases			4			8			2			6
Detector Phase	7	4	4	3	8	8	5	2	2	1	6	6
Switch Phase												
Minimum Initial (s)	3.6	2.0	2.0	3.6	10.0	10.0	8.0	10.0	10.0	8.0	10.0	10.0
Minimum Split (s)	11.0	11.0	11.0	11.0	20.0	20.0	16.2	34.0	34.0	16.2	19.0	19.0
Total Split (s)	21.0	47.0	47.0	12.0	38.0	38.0	24.0	38.0	38.0	18.0	32.0	32.0

Lanes, Volumes, Timings

3: Tower Road & 104th Avenue

09/21/2023



Lane Group	EBL	EBT	EBR	WBL	WBT	WBR	NBL	NBT	NBR	SBL	SBT	SBR
Total Split (%)	18.3%	40.9%	40.9%	10.4%	33.0%	33.0%	20.9%	33.0%	33.0%	15.7%	27.8%	27.8%
Maximum Green (s)	13.6	39.6	39.6	4.6	30.6	30.6	15.8	29.8	29.8	9.8	23.8	23.8
Yellow Time (s)	5.0	5.0	5.0	5.0	5.0	5.0	5.1	5.1	5.1	5.1	5.1	5.1
All-Red Time (s)	2.4	2.4	2.4	2.4	2.4	2.4	3.1	3.1	3.1	3.1	3.1	3.1
Lost Time Adjust (s)	0.0	0.0	0.0	0.0	0.0	0.0	0.0	0.0	0.0	0.0	0.0	0.0
Total Lost Time (s)	7.4	7.4	7.4	7.4	7.4	7.4	8.2	8.2	8.2	8.2	8.2	8.2
Lead/Lag	Lead	Lag	Lag	Lead	Lag	Lag	Lead	Lag	Lag	Lead	Lag	Lag
Lead-Lag Optimize?	Yes	Yes	Yes	Yes	Yes	Yes	Yes	Yes	Yes	Yes	Yes	Yes
Vehicle Extension (s)	2.0	2.0	2.0	2.0	2.0	2.0	2.0	5.0	5.0	2.0	5.0	5.0
Recall Mode	None	None	None	None	None	None	None	C-Min	C-Min	None	C-Min	C-Min
Act Effect Green (s)	11.3	42.0	42.0	4.6	32.9	32.9	15.8	38.1	38.1	8.0	23.8	23.8
Actuated g/C Ratio	0.10	0.37	0.37	0.04	0.29	0.29	0.14	0.33	0.33	0.07	0.21	0.21
v/c Ratio	0.65	0.32	1.25	0.43	0.14	0.02	1.07	0.56	0.16	0.12	1.18	0.33
Control Delay	58.9	27.5	147.9	63.9	31.4	0.1	109.3	34.5	0.5	51.5	132.8	2.2
Queue Delay	0.0	0.0	0.0	0.0	0.0	0.0	0.0	0.0	0.0	0.0	0.0	0.0
Total Delay	58.9	27.5	147.9	63.9	31.4	0.1	109.3	34.5	0.5	51.5	132.8	2.2
LOS	E	C	F	E	C	A	F	C	A	D	F	A
Approach Delay		96.5			36.8			56.3			115.3	
Approach LOS		F			D			E			F	

Intersection Summary

Area Type: Other
 Cycle Length: 115
 Actuated Cycle Length: 115
 Offset: 0 (0%), Referenced to phase 2:NBT and 6:SBT, Start of Yellow, Master Intersection
 Natural Cycle: 145
 Control Type: Actuated-Coordinated
 Maximum v/c Ratio: 1.25
 Intersection Signal Delay: 86.2
 Intersection LOS: F
 Intersection Capacity Utilization 99.6%
 ICU Level of Service F
 Analysis Period (min) 15

Splits and Phases: 3: Tower Road & 104th Avenue

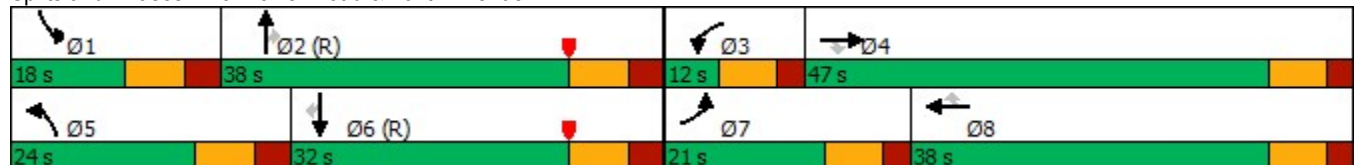

Queues

3: Tower Road & 104th Avenue

09/21/2023



Lane Group	EBL	EBT	EBR	WBL	WBT	WBR	NBL	NBT	NBR	SBL	SBT	SBR
Lane Group Flow (vph)	218	596	961	59	208	13	505	942	111	28	1245	177
v/c Ratio	0.65	0.32	1.25	0.43	0.14	0.02	1.07	0.56	0.16	0.12	1.18	0.33
Control Delay	58.9	27.5	147.9	63.9	31.4	0.1	109.3	34.5	0.5	51.5	132.8	2.2
Queue Delay	0.0	0.0	0.0	0.0	0.0	0.0	0.0	0.0	0.0	0.0	0.0	0.0
Total Delay	58.9	27.5	147.9	63.9	31.4	0.1	109.3	34.5	0.5	51.5	132.8	2.2
Queue Length 50th (ft)	81	119	~760	22	42	0	~213	227	0	10	~406	0
Queue Length 95th (ft)	115	152	#1011	38	63	0	#310	276	0	22	#501	0
Internal Link Dist (ft)		1030			760			540			920	
Turn Bay Length (ft)	350		590	330		440	320		290	290		190
Base Capacity (vph)	405	1857	768	137	1454	643	471	1683	697	292	1052	533
Starvation Cap Reductn	0	0	0	0	0	0	0	0	0	0	0	0
Spillback Cap Reductn	0	0	0	0	0	0	0	0	0	0	0	0
Storage Cap Reductn	0	0	0	0	0	0	0	0	0	0	0	0
Reduced v/c Ratio	0.54	0.32	1.25	0.43	0.14	0.02	1.07	0.56	0.16	0.10	1.18	0.33



































Intersection Summary

- ~ Volume exceeds capacity, queue is theoretically infinite.
Queue shown is maximum after two cycles.
- # 95th percentile volume exceeds capacity, queue may be longer.
Queue shown is maximum after two cycles.

HCM 6th Signalized Intersection Summary

3: Tower Road & 104th Avenue

09/21/2023

												
Movement	EBL	EBT	EBR	WBL	WBT	WBR	NBL	NBT	NBR	SBL	SBT	SBR
Lane Configurations	 	  		 	  		 	  		 	 	
Traffic Volume (veh/h)	190	548	884	46	181	10	444	867	89	22	1158	149
Future Volume (veh/h)	190	548	884	46	181	10	444	867	89	22	1158	149
Initial Q (Qb), veh	0	0	0	0	0	0	0	0	0	0	0	0
Ped-Bike Adj(A_pbT)	1.00		1.00	1.00		1.00	1.00		1.00	1.00		1.00
Parking Bus, Adj	1.00	1.00	1.00	1.00	1.00	1.00	1.00	1.00	1.00	1.00	1.00	1.00
Work Zone On Approach		No			No			No			No	
Adj Sat Flow, veh/h/ln	1870	1870	1870	1870	1870	1870	1870	1870	1870	1870	1870	1870
Adj Flow Rate, veh/h	218	596	0	59	208	0	505	942	0	28	1245	0
Peak Hour Factor	0.87	0.92	0.92	0.78	0.87	0.78	0.88	0.92	0.80	0.78	0.93	0.84
Percent Heavy Veh, %	2	2	2	2	2	2	2	2	2	2	2	2
Cap, veh/h	279	728		101	464		475	2634		142	2142	
Arrive On Green	0.08	0.14	0.00	0.03	0.09	0.00	0.14	0.52	0.00	0.04	0.42	0.00
Sat Flow, veh/h	3456	5106	1585	3456	5106	1585	3456	5106	1585	3456	5106	1585
Grp Volume(v), veh/h	218	596	0	59	208	0	505	942	0	28	1245	0
Grp Sat Flow(s),veh/h/ln	1728	1702	1585	1728	1702	1585	1728	1702	1585	1728	1702	1585
Q Serve(g_s), s	7.1	13.0	0.0	1.9	4.4	0.0	15.8	12.6	0.0	0.9	21.5	0.0
Cycle Q Clear(g_c), s	7.1	13.0	0.0	1.9	4.4	0.0	15.8	12.6	0.0	0.9	21.5	0.0
Prop In Lane	1.00		1.00	1.00		1.00	1.00		1.00	1.00		1.00
Lane Grp Cap(c), veh/h	279	728		101	464		475	2634		142	2142	
V/C Ratio(X)	0.78	0.82		0.59	0.45		1.06	0.36		0.20	0.58	
Avail Cap(c_a), veh/h	409	1758		138	1359		475	2634		294	2142	
HCM Platoon Ratio	1.00	1.00	1.00	1.00	1.00	1.00	1.00	1.00	1.00	1.00	1.00	1.00
Upstream Filter(I)	1.00	1.00	0.00	1.00	1.00	0.00	1.00	1.00	0.00	1.00	1.00	0.00
Uniform Delay (d), s/veh	51.8	47.9	0.0	55.1	49.5	0.0	49.6	16.5	0.0	53.3	25.6	0.0
Incr Delay (d2), s/veh	3.1	0.9	0.0	2.0	0.3	0.0	59.3	0.4	0.0	0.2	1.2	0.0
Initial Q Delay(d3),s/veh	0.0	0.0	0.0	0.0	0.0	0.0	0.0	0.0	0.0	0.0	0.0	0.0
%ile BackOfQ(50%),veh/ln	3.1	5.4	0.0	0.9	1.9	0.0	10.4	4.6	0.0	0.4	8.3	0.0
Unsig. Movement Delay, s/veh												
LnGrp Delay(d),s/veh	55.0	48.7	0.0	57.2	49.8	0.0	108.9	16.9	0.0	53.5	26.8	0.0
LnGrp LOS	D	D		E	D		F	B		D	C	
Approach Vol, veh/h		814			267			1447			1273	
Approach Delay, s/veh		50.4			51.4			49.0			27.4	
Approach LOS		D			D			D			C	
Timer - Assigned Phs	1	2	3	4	5	6	7	8				
Phs Duration (G+Y+Rc), s	12.9	67.5	10.7	23.8	24.0	56.5	16.7	17.8				
Change Period (Y+Rc), s	8.2	8.2	7.4	7.4	8.2	8.2	7.4	7.4				
Max Green Setting (Gmax), s	9.8	29.8	4.6	39.6	15.8	23.8	13.6	30.6				
Max Q Clear Time (g_c+I1), s	2.9	14.6	3.9	15.0	17.8	23.5	9.1	6.4				
Green Ext Time (p_c), s	0.0	6.9	0.0	1.4	0.0	0.2	0.2	0.4				

Intersection Summary

HCM 6th Ctrl Delay	42.2
HCM 6th LOS	D

Notes

User approved pedestrian interval to be less than phase max green.

Unsignalized Delay for [NBR, EBR, WBR, SBR] is excluded from calculations of the approach delay and intersection delay.

Lanes, Volumes, Timings
4: Tower Road & Private Access

09/21/2023



Lane Group	EBL	EBR	NBL	NBT	SBT	SBR
Lane Configurations						
Traffic Volume (vph)	0	25	0	1398	1403	116
Future Volume (vph)	0	25	0	1398	1403	116
Ideal Flow (vphpl)	1900	1900	1900	1900	1900	1900
Lane Util. Factor	1.00	1.00	1.00	0.95	0.91	0.91
Fr _t		0.865			0.987	
Fl _t Protected						
Satd. Flow (prot)	0	1611	0	3539	5019	0
Fl _t Permitted						
Satd. Flow (perm)	0	1611	0	3539	5019	0
Link Speed (mph)	30			50	30	
Link Distance (ft)	345			530	620	
Travel Time (s)	7.8			7.2	14.1	
Peak Hour Factor	0.78	0.78	0.78	0.93	0.93	0.84
Adj. Flow (vph)	0	32	0	1503	1509	138
Shared Lane Traffic (%)						
Lane Group Flow (vph)	0	32	0	1503	1647	0
Enter Blocked Intersection	No	No	No	No	No	No
Lane Alignment	Left	Right	Left	Left	Left	Right
Median Width(ft)	0			24	24	
Link Offset(ft)	0			0	0	
Crosswalk Width(ft)	16			16	16	
Two way Left Turn Lane						
Headway Factor	1.00	1.00	1.00	1.00	1.00	1.00
Turning Speed (mph)	15	9	15			9
Sign Control	Stop			Free	Free	

Intersection Summary

Area Type:	Other
Control Type:	Unsignalized
Intersection Capacity Utilization	42.0%
ICU Level of Service	A
Analysis Period (min)	15

Intersection						
Int Delay, s/veh	0.2					
Movement	EBL	EBR	NBL	NBT	SBT	SBR
Lane Configurations		↗		↑↑	↑↑↑	
Traffic Vol, veh/h	0	25	0	1398	1403	116
Future Vol, veh/h	0	25	0	1398	1403	116
Conflicting Peds, #/hr	0	0	0	0	0	0
Sign Control	Stop	Stop	Free	Free	Free	Free
RT Channelized	-	None	-	None	-	None
Storage Length	-	0	-	-	-	-
Veh in Median Storage, #	0	-	-	0	0	-
Grade, %	0	-	-	0	0	-
Peak Hour Factor	78	78	78	93	93	84
Heavy Vehicles, %	2	2	2	2	2	2
Mvmt Flow	0	32	0	1503	1509	138























Major/Minor	Minor2	Major1	Major2		
Conflicting Flow All	-	824	-	0	0
Stage 1	-	-	-	-	-
Stage 2	-	-	-	-	-
Critical Hdwy	-	7.14	-	-	-
Critical Hdwy Stg 1	-	-	-	-	-
Critical Hdwy Stg 2	-	-	-	-	-
Follow-up Hdwy	-	3.92	-	-	-
Pot Cap-1 Maneuver	0	271	0	-	-
Stage 1	0	-	0	-	-
Stage 2	0	-	0	-	-
Platoon blocked, %				-	-
Mov Cap-1 Maneuver	-	271	-	-	-
Mov Cap-2 Maneuver	-	-	-	-	-
Stage 1	-	-	-	-	-
Stage 2	-	-	-	-	-

Approach	EB	NB	SB
HCM Control Delay, s	20.1	0	0
HCM LOS	C		

Minor Lane/Major Mvmt	NBT	EBLn1	SBT	SBR
Capacity (veh/h)	-	271	-	-
HCM Lane V/C Ratio	-	0.118	-	-
HCM Control Delay (s)	-	20.1	-	-
HCM Lane LOS	-	C	-	-
HCM 95th %tile Q(veh)	-	0.4	-	-

Lanes, Volumes, Timings
5: 103rd Avenue & Tower Road

09/21/2023

												
Lane Group	EBL	EBT	EBR	WBL	WBT	WBR	NBL	NBT	NBR	SBL	SBT	SBR
Lane Configurations												
Traffic Volume (vph)	2	1	51	80	1	205	85	1377	69	146	2130	22
Future Volume (vph)	2	1	51	80	1	205	85	1377	69	146	2130	22
Ideal Flow (vphpl)	1900	1900	1900	1900	1900	1900	1900	1900	1900	1900	1900	1900
Storage Length (ft)	45		50	100		100	440		185	130		0
Storage Lanes	0		1	0		1	1		1	1		1
Taper Length (ft)	25			25			25			25		
Lane Util. Factor	1.00	1.00	1.00	1.00	1.00	1.00	1.00	0.91	1.00	1.00	0.91	1.00
Frt			0.850			0.850			0.850			0.850
Flt Protected		0.964			0.953		0.950			0.950		
Satd. Flow (prot)	0	1796	1583	0	1775	1583	1770	5085	1583	1770	5085	1583
Flt Permitted		0.964			0.953		0.104			0.105		
Satd. Flow (perm)	0	1796	1583	0	1775	1583	194	5085	1583	196	5085	1583
Right Turn on Red			Yes			Yes			Yes			Yes
Satd. Flow (RTOR)			125			236			177			125
Link Speed (mph)		30			30			50			30	
Link Distance (ft)		875			922			428			530	
Travel Time (s)		19.9			21.0			5.8			12.0	
Peak Hour Factor	0.78	0.78	0.78	0.80	0.78	0.87	0.83	0.93	0.79	0.84	0.95	0.78
Adj. Flow (vph)	3	1	65	100	1	236	102	1481	87	174	2242	28
Shared Lane Traffic (%)												
Lane Group Flow (vph)	0	4	65	0	101	236	102	1481	87	174	2242	28
Enter Blocked Intersection	No	No	No	No	No	No	No	No	No	No	No	No
Lane Alignment	Left	Left	Right	Left	Left	Right	Left	Left	Right	Left	Left	Right
Median Width(ft)		0			0			12			12	
Link Offset(ft)		0			0			0			0	
Crosswalk Width(ft)		16			16			16			16	
Two way Left Turn Lane												
Headway Factor	1.00	1.00	1.00	1.00	1.00	1.00	1.00	1.00	1.00	1.00	1.00	1.00
Turning Speed (mph)	15		9	15		60	15		9	60		9
Number of Detectors	1	1	1	1	1	0	1	2	1	1	2	1
Detector Template	Left	Thru	Right	Left	Thru	Right	Left	Thru	Right	Left	Thru	Right
Leading Detector (ft)	20	20	20	20	20	0	20	100	20	20	100	20
Trailing Detector (ft)	0	0	0	0	0	0	0	0	0	0	0	0
Detector 1 Position(ft)	0	0	0	0	0	0	0	0	0	0	0	0
Detector 1 Size(ft)	20	20	20	20	20	20	20	6	20	20	6	20
Detector 1 Type	Cl+Ex	Cl+Ex	Cl+Ex	Cl+Ex	Cl+Ex	Cl+Ex	Cl+Ex	Cl+Ex	Cl+Ex	Cl+Ex	Cl+Ex	Cl+Ex
Detector 1 Channel												
Detector 1 Extend (s)	0.0	0.0	0.0	0.0	0.0	0.0	0.0	0.0	0.0	0.0	0.0	0.0
Detector 1 Queue (s)	0.0	0.0	0.0	0.0	0.0	0.0	0.0	0.0	0.0	0.0	0.0	0.0
Detector 1 Delay (s)	0.0	0.0	0.0	0.0	0.0	0.0	0.0	0.0	0.0	0.0	0.0	0.0
Detector 2 Position(ft)								94			94	
Detector 2 Size(ft)								6			6	
Detector 2 Type								Cl+Ex			Cl+Ex	
Detector 2 Channel												
Detector 2 Extend (s)								0.0			0.0	
Turn Type	Split	NA	pm+ov	Split	NA	pm+ov	pm+pt	NA	Perm	pm+pt	NA	Perm
Protected Phases	4	4	5	8	8	1	5	2		1	6	
Permitted Phases			4			8	2		2	6		6

Lanes, Volumes, Timings
5: 103rd Avenue & Tower Road

09/21/2023



Lane Group	EBL	EBT	EBR	WBL	WBT	WBR	NBL	NBT	NBR	SBL	SBT	SBR
Detector Phase	4	4	5	8	8	1	5	2	2	1	6	6
Switch Phase												
Minimum Initial (s)	5.0	5.0	4.5	5.0	5.0	5.0	4.5	5.0	5.0	5.0	5.0	5.0
Minimum Split (s)	25.0	25.0	10.0	23.5	23.5	10.5	10.0	23.5	23.5	10.5	23.5	23.5
Total Split (s)	25.0	25.0	10.0	23.5	23.5	15.8	10.0	40.7	40.7	15.8	46.5	46.5
Total Split (%)	23.8%	23.8%	9.5%	22.4%	22.4%	15.0%	9.5%	38.8%	38.8%	15.0%	44.3%	44.3%
Maximum Green (s)	20.0	20.0	5.0	18.5	18.5	10.8	5.0	35.7	35.7	10.8	41.5	41.5
Yellow Time (s)	3.0	3.0	3.0	3.0	3.0	3.0	3.0	3.0	3.0	3.0	3.0	3.0
All-Red Time (s)	2.0	2.0	2.0	2.0	2.0	2.0	2.0	2.0	2.0	2.0	2.0	2.0
Lost Time Adjust (s)		0.0	0.0		0.0	0.0	0.0	0.0	0.0	0.0	0.0	0.0
Total Lost Time (s)		5.0	5.0		5.0	5.0	5.0	5.0	5.0	5.0	5.0	5.0
Lead/Lag			Lead			Lead	Lead	Lag	Lag	Lead	Lag	Lag
Lead-Lag Optimize?			Yes			Yes	Yes	Yes	Yes	Yes	Yes	Yes
Vehicle Extension (s)	3.0	3.0	3.0	3.0	3.0	3.0	3.0	3.0	3.0	3.0	3.0	3.0
Recall Mode	None	None	None	None	None	None	None	Min	Min	None	Min	Min
Walk Time (s)	7.0	7.0		7.0	7.0			7.0	7.0		7.0	7.0
Flash Dont Walk (s)	11.0	11.0		11.0	11.0			11.0	11.0		11.0	11.0
Pedestrian Calls (#/hr)	0	0		0	0			0	0		0	0
Act Effct Green (s)		6.0	6.2		9.5	19.8	42.2	37.0	37.0	49.8	44.7	44.7
Actuated g/C Ratio		0.09	0.09		0.14	0.29	0.61	0.54	0.54	0.72	0.65	0.65
v/c Ratio		0.03	0.25		0.42	0.38	0.43	0.54	0.09	0.52	0.68	0.03
Control Delay		35.0	2.8		35.7	4.9	14.8	13.6	0.2	14.6	13.9	0.0
Queue Delay		0.0	0.0		0.0	0.0	0.0	0.0	0.0	0.0	0.0	0.0
Total Delay		35.0	2.8		35.7	4.9	14.8	13.6	0.2	14.6	13.9	0.0
LOS		C	A		D	A	B	B	A	B	B	A
Approach Delay		4.7			14.1			13.0			13.8	
Approach LOS		A			B			B			B	

Intersection Summary

Area Type:	Other
Cycle Length:	105
Actuated Cycle Length:	69.1
Natural Cycle:	115
Control Type:	Actuated-Uncoordinated
Maximum v/c Ratio:	0.68
Intersection Signal Delay:	13.4
Intersection LOS:	B
Intersection Capacity Utilization:	69.5%
ICU Level of Service:	C
Analysis Period (min):	15

Splits and Phases: 5: 103rd Avenue & Tower Road

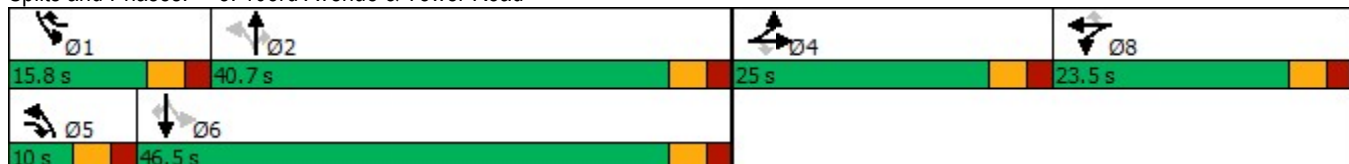

Queues

5: 103rd Avenue & Tower Road

09/21/2023

























Lane Group	EBT	EBR	WBT	WBR	NBL	NBT	NBR	SBL	SBT	SBR
Lane Group Flow (vph)	4	65	101	236	102	1481	87	174	2242	28
v/c Ratio	0.03	0.25	0.42	0.38	0.43	0.54	0.09	0.52	0.68	0.03
Control Delay	35.0	2.8	35.7	4.9	14.8	13.6	0.2	14.6	13.9	0.0
Queue Delay	0.0	0.0	0.0	0.0	0.0	0.0	0.0	0.0	0.0	0.0
Total Delay	35.0	2.8	35.7	4.9	14.8	13.6	0.2	14.6	13.9	0.0
Queue Length 50th (ft)	2	0	41	0	10	140	0	18	238	0
Queue Length 95th (ft)	10	0	83	42	46	291	0	85	#491	0
Internal Link Dist (ft)	795		842			348			450	
Turn Bay Length (ft)		50		100	440		185	130		
Base Capacity (vph)	541	256	495	676	237	2839	961	400	3292	1069
Starvation Cap Reductn	0	0	0	0	0	0	0	0	0	0
Spillback Cap Reductn	0	0	0	0	0	0	0	0	0	0
Storage Cap Reductn	0	0	0	0	0	0	0	0	0	0
Reduced v/c Ratio	0.01	0.25	0.20	0.35	0.43	0.52	0.09	0.43	0.68	0.03

Intersection Summary

95th percentile volume exceeds capacity, queue may be longer.
 Queue shown is maximum after two cycles.

























HCM 6th Signalized Intersection Summary
5: 103rd Avenue & Tower Road

09/21/2023

												
Movement	EBL	EBT	EBR	WBL	WBT	WBR	NBL	NBT	NBR	SBL	SBT	SBR
Lane Configurations												
Traffic Volume (veh/h)	2	1	51	80	1	205	85	1377	69	146	2130	22
Future Volume (veh/h)	2	1	51	80	1	205	85	1377	69	146	2130	22
Initial Q (Qb), veh	0	0	0	0	0	0	0	0	0	0	0	0
Ped-Bike Adj(A_pbT)	1.00		1.00	1.00		1.00	1.00		1.00	1.00		1.00
Parking Bus, Adj	1.00	1.00	1.00	1.00	1.00	1.00	1.00	1.00	1.00	1.00	1.00	1.00
Work Zone On Approach		No			No			No			No	
Adj Sat Flow, veh/h/ln	1870	1870	1870	1870	1870	1870	1870	1870	1870	1870	1870	1870
Adj Flow Rate, veh/h	3	1	65	100	1	236	102	1481	87	174	2242	28
Peak Hour Factor	0.78	0.78	0.78	0.80	0.78	0.87	0.83	0.93	0.79	0.84	0.95	0.78
Percent Heavy Veh, %	2	2	2	2	2	2	2	2	2	2	2	2
Cap, veh/h	69	23	166	147	1	246	223	2662	826	342	2756	856
Arrive On Green	0.05	0.05	0.05	0.08	0.08	0.08	0.05	0.52	0.52	0.07	0.54	0.54
Sat Flow, veh/h	1352	451	1585	1764	18	1585	1781	5106	1585	1781	5106	1585
Grp Volume(v), veh/h	4	0	65	101	0	236	102	1481	87	174	2242	28
Grp Sat Flow(s),veh/h/ln	1803	0	1585	1782	0	1585	1781	1702	1585	1781	1702	1585
Q Serve(g_s), s	0.2	0.0	2.8	4.0	0.0	6.1	1.9	14.4	2.0	3.2	26.5	0.6
Cycle Q Clear(g_c), s	0.2	0.0	2.8	4.0	0.0	6.1	1.9	14.4	2.0	3.2	26.5	0.6
Prop In Lane	0.75		1.00	0.99		1.00	1.00		1.00	1.00		1.00
Lane Grp Cap(c), veh/h	93	0	166	148	0	246	223	2662	826	342	2756	856
V/C Ratio(X)	0.04	0.00	0.39	0.68	0.00	0.96	0.46	0.56	0.11	0.51	0.81	0.03
Avail Cap(c_a), veh/h	490	0	516	448	0	513	249	2662	826	476	2882	895
HCM Platoon Ratio	1.00	1.00	1.00	1.00	1.00	1.00	1.00	1.00	1.00	1.00	1.00	1.00
Upstream Filter(l)	1.00	0.00	1.00	1.00	0.00	1.00	1.00	1.00	1.00	1.00	1.00	1.00
Uniform Delay (d), s/veh	33.2	0.0	30.7	32.8	0.0	30.8	15.1	11.9	8.9	9.5	13.9	7.9
Incr Delay (d2), s/veh	0.2	0.0	1.5	5.4	0.0	18.6	1.5	0.3	0.1	1.2	1.8	0.0
Initial Q Delay(d3),s/veh	0.0	0.0	0.0	0.0	0.0	0.0	0.0	0.0	0.0	0.0	0.0	0.0
%ile BackOfQ(50%),veh/ln	0.1	0.0	1.1	1.9	0.0	5.2	0.8	4.2	0.6	1.2	9.1	0.2
Unsig. Movement Delay, s/veh												
LnGrp Delay(d),s/veh	33.3	0.0	32.2	38.2	0.0	49.4	16.6	12.1	9.0	10.7	15.7	7.9
LnGrp LOS	C	A	C	D	A	D	B	B	A	B	B	A
Approach Vol, veh/h		69			337			1670			2444	
Approach Delay, s/veh		32.3			46.0			12.2			15.2	
Approach LOS		C			D			B			B	
Timer - Assigned Phs	1	2		4	5	6		8				
Phs Duration (G+Y+Rc), s	10.3	43.3		8.8	8.9	44.7		11.1				
Change Period (Y+Rc), s	5.0	5.0		5.0	5.0	5.0		5.0				
Max Green Setting (Gmax), s	10.8	35.7		20.0	5.0	41.5		18.5				
Max Q Clear Time (g_c+I1), s	5.2	16.4		4.8	3.9	28.5		6.0				
Green Ext Time (p_c), s	0.2	9.9		0.1	0.0	11.2		0.1				
Intersection Summary												
HCM 6th Ctrl Delay			16.7									
HCM 6th LOS			B									

Lanes, Volumes, Timings
1: Walden Street & 104th Avenue

09/21/2023

												
Lane Group	EBL	EBT	EBR	WBL	WBT	WBR	NBL	NBT	NBR	SBL	SBT	SBR
Lane Configurations												
Traffic Volume (vph)	93	1000	156	25	1380	162	212	47	45	224	17	76
Future Volume (vph)	93	1000	156	25	1380	162	212	47	45	224	17	76
Ideal Flow (vphpl)	1900	1900	1900	1900	1900	1900	1900	1900	1900	1900	1900	1900
Storage Length (ft)	400		230	0		250	230		230	210		140
Storage Lanes	1		1	1		1	1		1	1		1
Taper Length (ft)	25			25			25			25		
Lane Util. Factor	1.00	0.95	1.00	1.00	0.95	1.00	1.00	1.00	1.00	1.00	1.00	1.00
Frt			0.850			0.850			0.850			0.850
Flt Protected	0.950			0.950			0.950			0.950		
Satd. Flow (prot)	1770	3539	1583	1770	3539	1583	1770	1863	1583	1770	1863	1583
Flt Permitted	0.064			0.199			0.743			0.499		
Satd. Flow (perm)	119	3539	1583	371	3539	1583	1384	1863	1583	930	1863	1583
Right Turn on Red			Yes			Yes			Yes			Yes
Satd. Flow (RTOR)			186			159			168			168
Link Speed (mph)		45			45			30				30
Link Distance (ft)		149			767			699				204
Travel Time (s)		2.3			11.6			15.9				4.6
Peak Hour Factor	0.80	0.93	0.84	0.78	0.93	0.84	0.88	0.78	0.78	0.87	0.78	0.80
Adj. Flow (vph)	116	1075	186	32	1484	193	241	60	58	257	22	95
Shared Lane Traffic (%)												
Lane Group Flow (vph)	116	1075	186	32	1484	193	241	60	58	257	22	95
Enter Blocked Intersection	No	No	No	No	No	No	No	No	No	No	No	No
Lane Alignment	Left	Left	Right	Left	Left	Right	Left	Left	Right	Left	Left	Right
Median Width(ft)		12			12			12				12
Link Offset(ft)		0			0			0				0
Crosswalk Width(ft)		16			16			16				16
Two way Left Turn Lane												
Headway Factor	1.00	1.00	1.00	1.00	1.00	1.00	1.00	1.00	1.00	1.00	1.00	1.00
Turning Speed (mph)	15		9	15		9	15		9	15		9
Number of Detectors	1	2	1	1	2	1	1	2	1	1	2	1
Detector Template	Left	Thru	Right	Left	Thru	Right	Left	Thru	Right	Left	Thru	Right
Leading Detector (ft)	20	100	20	20	100	20	20	100	20	20	100	20
Trailing Detector (ft)	0	0	0	0	0	0	0	0	0	0	0	0
Detector 1 Position(ft)	0	0	0	0	0	0	0	0	0	0	0	0
Detector 1 Size(ft)	20	6	20	20	6	20	20	6	20	20	6	20
Detector 1 Type	Cl+Ex	Cl+Ex	Cl+Ex	Cl+Ex	Cl+Ex	Cl+Ex	Cl+Ex	Cl+Ex	Cl+Ex	Cl+Ex	Cl+Ex	Cl+Ex
Detector 1 Channel												
Detector 1 Extend (s)	0.0	0.0	0.0	0.0	0.0	0.0	0.0	0.0	0.0	0.0	0.0	0.0
Detector 1 Queue (s)	0.0	0.0	0.0	0.0	0.0	0.0	0.0	0.0	0.0	0.0	0.0	0.0
Detector 1 Delay (s)	0.0	0.0	0.0	0.0	0.0	0.0	0.0	0.0	0.0	0.0	0.0	0.0
Detector 2 Position(ft)		94			94			94				94
Detector 2 Size(ft)		6			6			6				6
Detector 2 Type		Cl+Ex			Cl+Ex			Cl+Ex				Cl+Ex
Detector 2 Channel												
Detector 2 Extend (s)		0.0			0.0			0.0				0.0
Turn Type	pm+pt	NA	Perm	pm+pt	NA	Perm	pm+pt	NA	Perm	pm+pt	NA	Perm
Protected Phases	5	2		1	6		3	8		7	4	
Permitted Phases	2		2	6		6	8		8	4		4

Lanes, Volumes, Timings
1: Walden Street & 104th Avenue

09/21/2023

Lane Group	EBL	EBT	EBR	WBL	WBT	WBR	NBL	NBT	NBR	SBL	SBT	SBR
Detector Phase	5	2	2	1	6	6	3	8	8	7	4	4
Switch Phase												
Minimum Initial (s)	5.0	10.0	10.0	5.0	10.0	10.0	8.0	10.0	10.0	8.0	10.0	10.0
Minimum Split (s)	12.5	17.5	17.5	12.5	17.5	17.5	14.5	16.5	16.5	14.5	16.5	16.5
Total Split (s)	15.6	68.6	68.6	12.6	65.6	65.6	22.0	16.6	16.6	22.2	16.8	16.8
Total Split (%)	13.0%	57.2%	57.2%	10.5%	54.7%	54.7%	18.3%	13.8%	13.8%	18.5%	14.0%	14.0%
Maximum Green (s)	8.1	61.1	61.1	5.1	58.1	58.1	15.5	10.1	10.1	15.7	10.3	10.3
Yellow Time (s)	5.3	5.3	5.3	5.3	5.3	5.3	3.8	3.8	3.8	3.8	3.8	3.8
All-Red Time (s)	2.2	2.2	2.2	2.2	2.2	2.2	2.7	2.7	2.7	2.7	2.7	2.7
Lost Time Adjust (s)	0.0	0.0	0.0	0.0	0.0	0.0	0.0	0.0	0.0	0.0	0.0	0.0
Total Lost Time (s)	7.5	7.5	7.5	7.5	7.5	7.5	6.5	6.5	6.5	6.5	6.5	6.5
Lead/Lag	Lead	Lag	Lag	Lead	Lag	Lag	Lead	Lag	Lag	Lead	Lag	Lag
Lead-Lag Optimize?	Yes	Yes	Yes	Yes	Yes	Yes	Yes	Yes	Yes	Yes	Yes	Yes
Vehicle Extension (s)	2.0	5.0	5.0	2.0	5.0	5.0	2.0	2.0	2.0	2.0	2.0	2.0
Recall Mode	None	C-Max	C-Max	None	C-Max	C-Max	None	None	None	None	None	None
Act Effect Green (s)	71.5	66.6	66.6	64.4	59.3	59.3	23.1	10.0	10.0	26.7	10.2	10.2
Actuated g/C Ratio	0.60	0.56	0.56	0.54	0.49	0.49	0.19	0.08	0.08	0.22	0.08	0.08
v/c Ratio	0.67	0.55	0.19	0.12	0.85	0.22	0.77	0.39	0.20	0.76	0.14	0.33
Control Delay	39.0	19.4	2.7	6.7	20.7	1.2	56.8	59.8	1.6	54.8	53.1	3.1
Queue Delay	0.0	0.0	0.0	0.0	0.0	0.0	0.0	0.0	0.0	0.0	0.0	0.0
Total Delay	39.0	19.4	2.7	6.7	20.7	1.2	56.8	59.8	1.6	54.8	53.1	3.1
LOS	D	B	A	A	C	A	E	E	A	D	D	A
Approach Delay		18.8			18.3			48.4			41.6	
Approach LOS		B			B			D			D	

Intersection Summary

Area Type:	Other
Cycle Length:	120
Actuated Cycle Length:	120
Offset:	0 (0%), Referenced to phase 2:EBTL and 6:WBTL, Start of Yellow
Natural Cycle:	90
Control Type:	Actuated-Coordinated
Maximum v/c Ratio:	0.85
Intersection Signal Delay:	23.6
Intersection LOS:	C
Intersection Capacity Utilization:	80.3%
ICU Level of Service:	D
Analysis Period (min):	15

Splits and Phases: 1: Walden Street & 104th Avenue

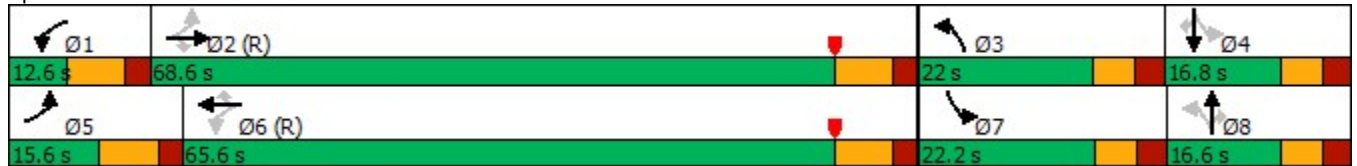

Queues

1: Walden Street & 104th Avenue

09/21/2023

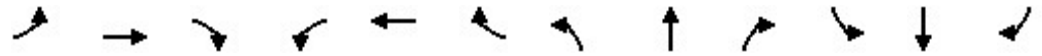

Lane Group	EBL	EBT	EBR	WBL	WBT	WBR	NBL	NBT	NBR	SBL	SBT	SBR
Lane Group Flow (vph)	116	1075	186	32	1484	193	241	60	58	257	22	95
v/c Ratio	0.67	0.55	0.19	0.12	0.85	0.22	0.77	0.39	0.20	0.76	0.14	0.33
Control Delay	39.0	19.4	2.7	6.7	20.7	1.2	56.8	59.8	1.6	54.8	53.1	3.1
Queue Delay	0.0	0.0	0.0	0.0	0.0	0.0	0.0	0.0	0.0	0.0	0.0	0.0
Total Delay	39.0	19.4	2.7	6.7	20.7	1.2	56.8	59.8	1.6	54.8	53.1	3.1
Queue Length 50th (ft)	37	298	0	5	444	6	159	45	0	171	16	0
Queue Length 95th (ft)	83	365	29	m9	424	m7	234	77	0	#246	37	0
Internal Link Dist (ft)		69			687			619			124	
Turn Bay Length (ft)	400		230			250	230		230	210		140
Base Capacity (vph)	182	1964	961	259	1748	862	320	156	287	337	159	289
Starvation Cap Reductn	0	0	0	0	0	0	0	0	0	0	0	0
Spillback Cap Reductn	0	0	0	0	0	0	0	0	0	0	0	0
Storage Cap Reductn	0	0	0	0	0	0	0	0	0	0	0	0
Reduced v/c Ratio	0.64	0.55	0.19	0.12	0.85	0.22	0.75	0.38	0.20	0.76	0.14	0.33

























Intersection Summary

- # 95th percentile volume exceeds capacity, queue may be longer.
Queue shown is maximum after two cycles.
- m Volume for 95th percentile queue is metered by upstream signal.

HCM 6th Signalized Intersection Summary

1: Walden Street & 104th Avenue

09/21/2023

												
Movement	EBL	EBT	EBR	WBL	WBT	WBR	NBL	NBT	NBR	SBL	SBT	SBR
Lane Configurations												
Traffic Volume (veh/h)	93	1000	156	25	1380	162	212	47	45	224	17	76
Future Volume (veh/h)	93	1000	156	25	1380	162	212	47	45	224	17	76
Initial Q (Qb), veh	0	0	0	0	0	0	0	0	0	0	0	0
Ped-Bike Adj(A_pbT)	1.00		1.00	1.00		1.00	1.00		1.00	1.00		1.00
Parking Bus, Adj	1.00	1.00	1.00	1.00	1.00	1.00	1.00	1.00	1.00	1.00	1.00	1.00
Work Zone On Approach		No			No			No			No	
Adj Sat Flow, veh/h/ln	1870	1870	1870	1870	1870	1870	1870	1870	1870	1870	1870	1870
Adj Flow Rate, veh/h	116	1075	186	32	1484	193	241	60	58	257	22	95
Peak Hour Factor	0.80	0.93	0.84	0.78	0.93	0.84	0.88	0.78	0.78	0.87	0.78	0.80
Percent Heavy Veh, %	2	2	2	2	2	2	2	2	2	2	2	2
Cap, veh/h	323	1866	832	276	1796	801	393	156	132	364	159	135
Arrive On Green	0.05	0.53	0.53	0.05	1.00	1.00	0.13	0.08	0.08	0.13	0.09	0.09
Sat Flow, veh/h	1781	3554	1585	1781	3554	1585	1781	1870	1585	1781	1870	1585
Grp Volume(v), veh/h	116	1075	186	32	1484	193	241	60	58	257	22	95
Grp Sat Flow(s),veh/h/ln	1781	1777	1585	1781	1777	1585	1781	1870	1585	1781	1870	1585
Q Serve(g_s), s	3.7	24.7	7.6	1.0	0.0	0.0	14.8	3.6	4.2	15.7	1.3	7.0
Cycle Q Clear(g_c), s	3.7	24.7	7.6	1.0	0.0	0.0	14.8	3.6	4.2	15.7	1.3	7.0
Prop In Lane	1.00		1.00	1.00		1.00	1.00		1.00	1.00		1.00
Lane Grp Cap(c), veh/h	323	1866	832	276	1796	801	393	156	132	364	159	135
V/C Ratio(X)	0.36	0.58	0.22	0.12	0.83	0.24	0.61	0.38	0.44	0.71	0.14	0.71
Avail Cap(c_a), veh/h	360	1866	832	303	1796	801	393	157	133	364	161	136
HCM Platoon Ratio	1.00	1.00	1.00	2.00	2.00	2.00	1.00	1.00	1.00	1.00	1.00	1.00
Upstream Filter(I)	1.00	1.00	1.00	1.00	1.00	1.00	1.00	1.00	1.00	1.00	1.00	1.00
Uniform Delay (d), s/veh	12.9	19.4	15.3	15.1	0.0	0.0	43.0	52.1	52.3	43.4	50.8	53.4
Incr Delay (d2), s/veh	0.2	1.3	0.6	0.1	4.5	0.7	2.1	0.6	0.9	5.2	0.1	13.0
Initial Q Delay(d3),s/veh	0.0	0.0	0.0	0.0	0.0	0.0	0.0	0.0	0.0	0.0	0.0	0.0
%ile BackOfQ(50%),veh/ln	1.4	9.8	2.9	0.4	1.1	0.2	6.7	1.7	1.7	7.5	0.6	3.3
Unsig. Movement Delay, s/veh												
LnGrp Delay(d),s/veh	13.1	20.7	15.9	15.2	4.5	0.7	45.1	52.7	53.2	48.6	51.0	66.4
LnGrp LOS	B	C	B	B	A	A	D	D	D	D	D	E
Approach Vol, veh/h		1377			1709			359			374	
Approach Delay, s/veh		19.4			4.3			47.7			53.3	
Approach LOS		B			A			D			D	
Timer - Assigned Phs	1	2	3	4	5	6	7	8				
Phs Duration (G+Y+Rc), s	10.8	70.5	22.0	16.7	13.1	68.2	22.2	16.5				
Change Period (Y+Rc), s	* 7.5	* 7.5	6.5	6.5	* 7.5	* 7.5	6.5	6.5				
Max Green Setting (Gmax), s	* 5.1	* 61	15.5	10.3	* 8.1	* 58	15.7	10.1				
Max Q Clear Time (g_c+I1), s	3.0	26.7	16.8	9.0	5.7	2.0	17.7	6.2				
Green Ext Time (p_c), s	0.0	18.2	0.0	0.0	0.0	35.3	0.0	0.1				
Intersection Summary												
HCM 6th Ctrl Delay			18.6									
HCM 6th LOS			B									
Notes												
* HCM 6th computational engine requires equal clearance times for the phases crossing the barrier.												

Lanes, Volumes, Timings
2: Yampa Street & 104th Avenue

09/21/2023



Lane Group	EBT	EBR	WBL	WBT	NBL	NBR
Lane Configurations	↑↑↑	↑	↓	↑↑↑		↓
Traffic Volume (vph)	1172	15	20	903	0	15
Future Volume (vph)	1172	15	20	903	0	15
Ideal Flow (vphpl)	1900	1900	1900	1900	1900	1900
Storage Length (ft)		50	50		0	0
Storage Lanes		1	1		0	1
Taper Length (ft)			25		25	
Lane Util. Factor	0.91	1.00	1.00	0.91	1.00	1.00
Frt		0.850				0.865
Flt Protected			0.950			
Satd. Flow (prot)	5085	1583	1770	5085	0	1611
Flt Permitted			0.950			
Satd. Flow (perm)	5085	1583	1770	5085	0	1611
Link Speed (mph)	35			45	30	
Link Distance (ft)	767			1110	440	
Travel Time (s)	14.9			16.8	10.0	
Peak Hour Factor	0.93	0.78	0.78	0.92	0.78	0.78
Adj. Flow (vph)	1260	19	26	982	0	19
Shared Lane Traffic (%)						
Lane Group Flow (vph)	1260	19	26	982	0	19
Enter Blocked Intersection	No	No	No	No	No	No
Lane Alignment	Left	Right	Left	Left	Left	Right
Median Width(ft)	24			24	0	
Link Offset(ft)	0			0	0	
Crosswalk Width(ft)	16			16	16	
Two way Left Turn Lane						
Headway Factor	1.00	1.00	1.00	1.00	1.00	1.00
Turning Speed (mph)		9	15		15	9
Sign Control	Free			Free	Stop	

Intersection Summary

Area Type:	Other
Control Type:	Unsignalized
Intersection Capacity Utilization	32.6%
ICU Level of Service	A
Analysis Period (min)	15

Intersection						
Int Delay, s/veh	0.3					
Movement	EBT	EBR	WBL	WBT	NBL	NBR
Lane Configurations	↑↑↑	↑	↑	↑↑↑		↑
Traffic Vol, veh/h	1172	15	20	903	0	15
Future Vol, veh/h	1172	15	20	903	0	15
Conflicting Peds, #/hr	0	0	0	0	0	0
Sign Control	Free	Free	Free	Free	Stop	Stop
RT Channelized	-	None	-	None	-	None
Storage Length	-	50	50	-	-	0
Veh in Median Storage, #	0	-	-	0	0	-
Grade, %	0	-	-	0	0	-
Peak Hour Factor	93	78	78	92	78	78
Heavy Vehicles, %	2	2	2	2	2	2
Mvmt Flow	1260	19	26	982	0	19

Major/Minor	Major1	Major2	Minor1		
Conflicting Flow All	0	0	1279	0	630
Stage 1	-	-	-	-	-
Stage 2	-	-	-	-	-
Critical Hdwy	-	-	5.34	-	7.14
Critical Hdwy Stg 1	-	-	-	-	-
Critical Hdwy Stg 2	-	-	-	-	-
Follow-up Hdwy	-	-	3.12	-	3.92
Pot Cap-1 Maneuver	-	-	286	-	364
Stage 1	-	-	-	0	-
Stage 2	-	-	-	0	-
Platoon blocked, %	-	-	-	-	-
Mov Cap-1 Maneuver	-	-	286	-	364
Mov Cap-2 Maneuver	-	-	-	-	-
Stage 1	-	-	-	-	-
Stage 2	-	-	-	-	-

Approach	EB	WB	NB
HCM Control Delay, s	0	0.5	15.4
HCM LOS			C

Minor Lane/Major Mvmt	NBLn1	EBT	EBR	WBL	WBT
Capacity (veh/h)	364	-	-	286	-
HCM Lane V/C Ratio	0.053	-	-	0.09	-
HCM Control Delay (s)	15.4	-	-	18.8	-
HCM Lane LOS	C	-	-	C	-
HCM 95th %tile Q(veh)	0.2	-	-	0.3	-

Lanes, Volumes, Timings
3: Tower Road & 104th Avenue

09/21/2023



Lane Group	EBL	EBT	EBR	WBL	WBT	WBR	NBL	NBT	NBR	SBL	SBT	SBR
Lane Configurations	↖↖	↑↑↑	↗	↖↖	↑↑↑	↗	↖↖	↑↑↑	↗	↖↖	↑↑↑	↗
Traffic Volume (vph)	154	263	588	33	353	25	887	1495	41	14	875	119
Future Volume (vph)	154	263	588	33	353	25	887	1495	41	14	875	119
Ideal Flow (vphp)	1900	1900	1900	1900	1900	1900	1900	1900	1900	1900	1900	1900
Storage Length (ft)	350		590	330		440	320		290	290		190
Storage Lanes	2		1	2		1	2		1	2		1
Taper Length (ft)	25			25			25			25		
Lane Util. Factor	0.97	0.91	1.00	0.97	0.91	1.00	0.97	0.91	1.00	0.97	0.91	1.00
Frt			0.850			0.850			0.850			0.850
Flt Protected	0.950			0.950			0.950			0.950		
Satd. Flow (prot)	3433	5085	1583	3433	5085	1583	3433	5085	1583	3433	5085	1583
Flt Permitted	0.950			0.950			0.950			0.950		
Satd. Flow (perm)	3433	5085	1583	3433	5085	1583	3433	5085	1583	3433	5085	1583
Right Turn on Red			Yes			Yes			Yes			Yes
Satd. Flow (RTOR)			639			264			182			256
Link Speed (mph)		45			45			50			50	
Link Distance (ft)		1110			840			620			1000	
Travel Time (s)		16.8			12.7			8.5			13.6	
Peak Hour Factor	0.84	0.88	0.92	0.78	0.88	0.78	0.92	0.93	0.78	0.78	0.92	0.84
Adj. Flow (vph)	183	299	639	42	401	32	964	1608	53	18	951	142
Shared Lane Traffic (%)												
Lane Group Flow (vph)	183	299	639	42	401	32	964	1608	53	18	951	142
Enter Blocked Intersection	No	No	No	No	No	No	No	No	No	No	No	No
Lane Alignment	Left	Left	Right	Left	Left	Right	Left	Left	Right	Left	Left	Right
Median Width(ft)		24			24			24			24	
Link Offset(ft)		0			0			0			0	
Crosswalk Width(ft)		16			16			16			16	
Two way Left Turn Lane												
Headway Factor	1.00	1.00	1.00	1.00	1.00	1.00	1.00	1.00	1.00	1.00	1.00	1.00
Turning Speed (mph)	15		9	15		9	15		9	15		9
Number of Detectors	1	1	1	1	1	1	1	1	1	1	1	1
Detector Template	Left	Thru	Right	Left	Thru	Right	Left	Thru	Right	Left	Thru	Right
Leading Detector (ft)	40	40	40	40	40	40	40	40	40	40	40	40
Trailing Detector (ft)	0	0	0	0	0	0	0	0	0	0	0	0
Detector 1 Position(ft)	0	0	0	0	0	0	0	0	0	0	0	0
Detector 1 Size(ft)	40	40	40	40	40	40	40	40	40	40	40	40
Detector 1 Type	Cl+Ex	Cl+Ex	Cl+Ex	Cl+Ex	Cl+Ex	Cl+Ex	Cl+Ex	Cl+Ex	Cl+Ex	Cl+Ex	Cl+Ex	Cl+Ex
Detector 1 Channel												
Detector 1 Extend (s)	0.0	0.0	0.0	0.0	0.0	0.0	0.0	0.0	0.0	0.0	0.0	0.0
Detector 1 Queue (s)	0.0	0.0	0.0	0.0	0.0	0.0	0.0	0.0	0.0	0.0	0.0	0.0
Detector 1 Delay (s)	0.0	0.0	0.0	0.0	0.0	0.0	0.0	0.0	0.0	0.0	0.0	0.0
Turn Type	Prot	NA	Perm	Prot	NA	Perm	Prot	NA	Perm	Prot	NA	Perm
Protected Phases	7	4		3	8		5	2		1	6	
Permitted Phases			4			8			2			6
Detector Phase	7	4	4	3	8	8	5	2	2	1	6	6
Switch Phase												
Minimum Initial (s)	3.6	3.6	3.6	3.6	10.0	10.0	8.0	10.0	10.0	5.8	10.0	10.0
Minimum Split (s)	11.0	11.0	11.0	11.0	31.0	31.0	16.2	38.0	38.0	14.0	25.0	25.0
Total Split (s)	17.0	37.0	37.0	11.0	31.0	31.0	46.0	58.0	58.0	14.0	26.0	26.0

Lanes, Volumes, Timings
3: Tower Road & 104th Avenue

09/21/2023



Lane Group	EBL	EBT	EBR	WBL	WBT	WBR	NBL	NBT	NBR	SBL	SBT	SBR
Total Split (%)	14.2%	30.8%	30.8%	9.2%	25.8%	25.8%	38.3%	48.3%	48.3%	11.7%	21.7%	21.7%
Maximum Green (s)	9.6	29.6	29.6	3.6	23.6	23.6	37.8	49.8	49.8	5.8	17.8	17.8
Yellow Time (s)	5.0	5.0	5.0	5.0	5.0	5.0	5.1	5.1	5.1	5.1	5.1	5.1
All-Red Time (s)	2.4	2.4	2.4	2.4	2.4	2.4	3.1	3.1	3.1	3.1	3.1	3.1
Lost Time Adjust (s)	0.0	0.0	0.0	0.0	0.0	0.0	0.0	0.0	0.0	0.0	0.0	0.0
Total Lost Time (s)	7.4	7.4	7.4	7.4	7.4	7.4	8.2	8.2	8.2	8.2	8.2	8.2
Lead/Lag	Lead	Lag	Lag	Lead	Lag	Lag	Lead	Lag	Lag	Lead	Lag	Lag
Lead-Lag Optimize?	Yes	Yes	Yes	Yes	Yes	Yes	Yes	Yes	Yes	Yes	Yes	Yes
Vehicle Extension (s)	2.0	2.0	2.0	2.0	2.0	2.0	2.0	5.0	5.0	2.0	5.0	5.0
Recall Mode	None	None	None	None	None	None	None	C-Min	C-Min	None	C-Min	C-Min
Act Effct Green (s)	9.1	22.5	22.5	3.6	14.7	14.7	37.4	67.5	67.5	5.9	27.6	27.6
Actuated g/C Ratio	0.08	0.19	0.19	0.03	0.12	0.12	0.31	0.56	0.56	0.05	0.23	0.23
v/c Ratio	0.70	0.31	0.78	0.41	0.64	0.08	0.90	0.56	0.05	0.11	0.81	0.25
Control Delay	57.1	41.5	21.8	69.3	54.6	0.4	51.7	19.7	0.1	56.1	51.4	1.1
Queue Delay	0.0	0.0	0.0	0.0	0.0	0.0	0.0	0.0	0.0	0.0	0.0	0.0
Total Delay	57.1	41.5	21.8	69.3	54.6	0.4	51.7	19.7	0.1	56.1	51.4	1.1
LOS	E	D	C	E	D	A	D	B	A	E	D	A
Approach Delay		32.8			52.3			31.0			45.0	
Approach LOS		C			D			C			D	

Intersection Summary

Area Type: Other
 Cycle Length: 120
 Actuated Cycle Length: 120
 Offset: 0 (0%), Referenced to phase 2:NBT and 6:SBT, Start of Yellow, Master Intersection
 Natural Cycle: 115
 Control Type: Actuated-Coordinated
 Maximum v/c Ratio: 0.90
 Intersection Signal Delay: 36.2
 Intersection LOS: D
 Intersection Capacity Utilization 80.9%
 ICU Level of Service D
 Analysis Period (min) 15

Splits and Phases: 3: Tower Road & 104th Avenue

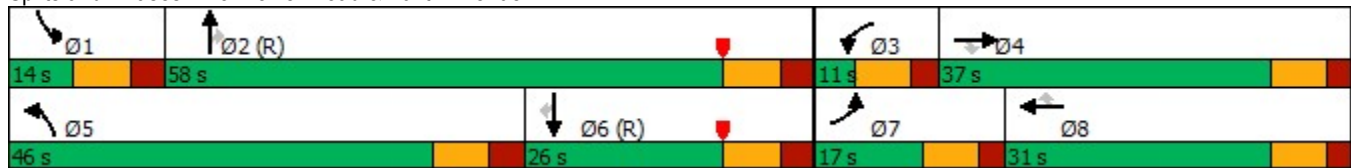

Queues

3: Tower Road & 104th Avenue

09/21/2023



Lane Group	EBL	EBT	EBR	WBL	WBT	WBR	NBL	NBT	NBR	SBL	SBT	SBR
Lane Group Flow (vph)	183	299	639	42	401	32	964	1608	53	18	951	142
v/c Ratio	0.70	0.31	0.78	0.41	0.64	0.08	0.90	0.56	0.05	0.11	0.81	0.25
Control Delay	57.1	41.5	21.8	69.3	54.6	0.4	51.7	19.7	0.1	56.1	51.4	1.1
Queue Delay	0.0	0.0	0.0	0.0	0.0	0.0	0.0	0.0	0.0	0.0	0.0	0.0
Total Delay	57.1	41.5	21.8	69.3	54.6	0.4	51.7	19.7	0.1	56.1	51.4	1.1
Queue Length 50th (ft)	73	83	234	17	110	0	362	242	0	7	258	0
Queue Length 95th (ft)	m103	m104	319	31	133	0	441	432	0	17	#430	0
Internal Link Dist (ft)		1030			760			540			920	
Turn Bay Length (ft)	350		590	330		440	320		290	290		190
Base Capacity (vph)	274	1254	871	102	1000	523	1116	2859	969	167	1168	560
Starvation Cap Reductn	0	0	0	0	0	0	0	0	0	0	0	0
Spillback Cap Reductn	0	0	0	0	0	0	0	0	0	0	0	0
Storage Cap Reductn	0	0	0	0	0	0	0	0	0	0	0	0
Reduced v/c Ratio	0.67	0.24	0.73	0.41	0.40	0.06	0.86	0.56	0.05	0.11	0.81	0.25

































Intersection Summary

- # 95th percentile volume exceeds capacity, queue may be longer.
Queue shown is maximum after two cycles.
- m Volume for 95th percentile queue is metered by upstream signal.

HCM 6th Signalized Intersection Summary

3: Tower Road & 104th Avenue

09/21/2023

												
Movement	EBL	EBT	EBR	WBL	WBT	WBR	NBL	NBT	NBR	SBL	SBT	SBR
Lane Configurations	 	  		 	  		 	  		 		
Traffic Volume (veh/h)	154	263	588	33	353	25	887	1495	41	14	875	119
Future Volume (veh/h)	154	263	588	33	353	25	887	1495	41	14	875	119
Initial Q (Qb), veh	0	0	0	0	0	0	0	0	0	0	0	0
Ped-Bike Adj(A_pbT)	1.00		1.00	1.00		1.00	1.00		1.00	1.00		1.00
Parking Bus, Adj	1.00	1.00	1.00	1.00	1.00	1.00	1.00	1.00	1.00	1.00	1.00	1.00
Work Zone On Approach		No			No			No			No	
Adj Sat Flow, veh/h/ln	1870	1870	1870	1870	1870	1870	1870	1870	1870	1870	1870	1870
Adj Flow Rate, veh/h	183	299	0	42	401	0	964	1608	0	18	951	0
Peak Hour Factor	0.84	0.88	0.92	0.78	0.88	0.78	0.92	0.93	0.78	0.78	0.92	0.84
Percent Heavy Veh, %	2	2	2	2	2	2	2	2	2	2	2	2
Cap, veh/h	240	749		78	509		1026	2802		75	1398	
Arrive On Green	0.02	0.05	0.00	0.02	0.10	0.00	0.30	0.55	0.00	0.02	0.27	0.00
Sat Flow, veh/h	3456	5106	1585	3456	5106	1585	3456	5106	1585	3456	5106	1585
Grp Volume(v), veh/h	183	299	0	42	401	0	964	1608	0	18	951	0
Grp Sat Flow(s),veh/h/ln	1728	1702	1585	1728	1702	1585	1728	1702	1585	1728	1702	1585
Q Serve(g_s), s	6.3	6.8	0.0	1.4	9.2	0.0	32.6	24.9	0.0	0.6	19.9	0.0
Cycle Q Clear(g_c), s	6.3	6.8	0.0	1.4	9.2	0.0	32.6	24.9	0.0	0.6	19.9	0.0
Prop In Lane	1.00		1.00	1.00		1.00	1.00		1.00	1.00		1.00
Lane Grp Cap(c), veh/h	240	749		78	509		1026	2802		75	1398	
V/C Ratio(X)	0.76	0.40		0.54	0.79		0.94	0.57		0.24	0.68	
Avail Cap(c_a), veh/h	276	1260		104	1004		1089	2802		167	1398	
HCM Platoon Ratio	0.33	0.33	0.33	1.00	1.00	1.00	1.00	1.00	1.00	1.00	1.00	1.00
Upstream Filter(I)	1.00	1.00	0.00	1.00	1.00	0.00	1.00	1.00	0.00	1.00	1.00	0.00
Uniform Delay (d), s/veh	57.6	52.0	0.0	58.0	52.8	0.0	41.1	17.8	0.0	57.7	38.9	0.0
Incr Delay (d2), s/veh	8.4	0.1	0.0	2.1	1.0	0.0	14.2	0.9	0.0	0.6	2.7	0.0
Initial Q Delay(d3),s/veh	0.0	0.0	0.0	0.0	0.0	0.0	0.0	0.0	0.0	0.0	0.0	0.0
%ile BackOfQ(50%),veh/ln	3.1	3.0	0.0	0.6	3.9	0.0	15.1	9.0	0.0	0.3	8.3	0.0
Unsig. Movement Delay, s/veh												
LnGrp Delay(d),s/veh	66.0	52.1	0.0	60.2	53.8	0.0	55.3	18.7	0.0	58.3	41.6	0.0
LnGrp LOS	E	D		E	D		E	B		E	D	
Approach Vol, veh/h		482			443			2572			969	
Approach Delay, s/veh		57.4			54.4			32.4			41.9	
Approach LOS		E			D			C			D	
Timer - Assigned Phs	1	2	3	4	5	6	7	8				
Phs Duration (G+Y+Rc), s	10.8	74.1	10.1	25.0	43.8	41.1	15.7	19.4				
Change Period (Y+Rc), s	8.2	8.2	7.4	7.4	8.2	8.2	7.4	7.4				
Max Green Setting (Gmax), s	5.8	49.8	3.6	29.6	37.8	17.8	9.6	23.6				
Max Q Clear Time (g_c+I1), s	2.6	26.9	3.4	8.8	34.6	21.9	8.3	11.2				
Green Ext Time (p_c), s	0.0	15.2	0.0	0.6	1.0	0.0	0.0	0.8				

Intersection Summary												
HCM 6th Ctrl Delay											39.3	
HCM 6th LOS											D	

Notes

User approved pedestrian interval to be less than phase max green.
 Unsignalized Delay for [NBR, EBR, WBR, SBR] is excluded from calculations of the approach delay and intersection delay.

Lanes, Volumes, Timings
4: Tower Road & Private Access

09/21/2023



Lane Group	EBL	EBR	NBL	NBT	SBT	SBR
Lane Configurations						
Traffic Volume (vph)	0	0	0	0	0	0
Future Volume (vph)	0	0	0	0	0	0
Ideal Flow (vphpl)	1900	1900	1900	1900	1900	1900
Lane Util. Factor	1.00	1.00	1.00	0.95	0.91	0.91
Frt						
Flt Protected						
Satd. Flow (prot)	0	1863	0	3539	5085	0
Flt Permitted						
Satd. Flow (perm)	0	1863	0	3539	5085	0
Link Speed (mph)	30			50	30	
Link Distance (ft)	345			530	620	
Travel Time (s)	7.8			7.2	14.1	
Peak Hour Factor	0.78	0.78	0.78	0.78	0.78	0.78
Adj. Flow (vph)	0	0	0	0	0	0
Shared Lane Traffic (%)						
Lane Group Flow (vph)	0	0	0	0	0	0
Enter Blocked Intersection	No	No	No	No	No	No
Lane Alignment	Left	Right	Left	Left	Left	Right
Median Width(ft)	0			24	24	
Link Offset(ft)	0			0	0	
Crosswalk Width(ft)	16			16	16	
Two way Left Turn Lane						
Headway Factor	1.00	1.00	1.00	1.00	1.00	1.00
Turning Speed (mph)	15	9	15			9
Sign Control	Stop			Free	Free	
Intersection Summary						
Area Type:	Other					
Control Type:	Unsignalized					
Intersection Capacity Utilization	0.0%			ICU Level of Service A		
Analysis Period (min)	15					

Intersection						
Int Delay, s/veh	0					
Movement	EBL	EBR	NBL	NBT	SBT	SBR
Lane Configurations		↗		↑↑	↑↑↑	
Traffic Vol, veh/h	0	0	0	0	0	0
Future Vol, veh/h	0	0	0	0	0	0
Conflicting Peds, #/hr	0	0	0	0	0	0
Sign Control	Stop	Stop	Free	Free	Free	Free
RT Channelized	-	None	-	None	-	None
Storage Length	-	0	-	-	-	-
Veh in Median Storage, #	0	-	-	0	0	-
Grade, %	0	-	-	0	0	-
Peak Hour Factor	78	78	78	78	78	78
Heavy Vehicles, %	2	2	2	2	2	2
Mvmt Flow	0	0	0	0	0	0























Major/Minor	Minor2	Major1	Major2		
Conflicting Flow All	-	1	-	0	-
Stage 1	-	-	-	-	-
Stage 2	-	-	-	-	-
Critical Hdwy	-	7.14	-	-	-
Critical Hdwy Stg 1	-	-	-	-	-
Critical Hdwy Stg 2	-	-	-	-	-
Follow-up Hdwy	-	3.92	-	-	-
Pot Cap-1 Maneuver	0	917	0	-	-
Stage 1	0	-	0	-	-
Stage 2	0	-	0	-	-
Platoon blocked, %				-	-
Mov Cap-1 Maneuver	-	917	-	-	-
Mov Cap-2 Maneuver	-	-	-	-	-
Stage 1	-	-	-	-	-
Stage 2	-	-	-	-	-

Approach	EB	NB	SB
HCM Control Delay, s	0	0	0
HCM LOS	A		

Minor Lane/Major Mvmt	NBT	EBLn1	SBT	SBR
Capacity (veh/h)	-	-	-	-
HCM Lane V/C Ratio	-	-	-	-
HCM Control Delay (s)	-	0	-	-
HCM Lane LOS	-	A	-	-
HCM 95th %tile Q(veh)	-	-	-	-

Lanes, Volumes, Timings
5: 103rd Avenue & Tower Road

09/21/2023

												
Lane Group	EBL	EBT	EBR	WBL	WBT	WBR	NBL	NBT	NBR	SBL	SBT	SBR
Lane Configurations												
Traffic Volume (vph)	11	1	51	191	1	388	168	2450	122	217	1695	12
Future Volume (vph)	11	1	51	191	1	388	168	2450	122	217	1695	12
Ideal Flow (vphpl)	1900	1900	1900	1900	1900	1900	1900	1900	1900	1900	1900	1900
Storage Length (ft)	45		50	100		100	440		185	130		0
Storage Lanes	0		1	0		1	1		1	1		1
Taper Length (ft)	25			25			25			25		
Lane Util. Factor	1.00	1.00	1.00	1.00	1.00	1.00	1.00	0.91	1.00	1.00	0.91	1.00
Frt			0.850			0.850			0.850			0.850
Flt Protected		0.955			0.953		0.950			0.950		
Satd. Flow (prot)	0	1779	1583	0	1775	1583	1770	5085	1583	1770	5085	1583
Flt Permitted		0.955			0.953		0.070			0.067		
Satd. Flow (perm)	0	1779	1583	0	1775	1583	130	5085	1583	125	5085	1583
Right Turn on Red			Yes			Yes			Yes			Yes
Satd. Flow (RTOR)			68			88			114			114
Link Speed (mph)		30			30			30			30	
Link Distance (ft)		875			922			428			530	
Travel Time (s)		19.9			21.0			9.7			12.0	
Peak Hour Factor	0.78	0.78	0.78	0.87	0.78	0.88	0.84	0.95	0.83	0.87	0.93	0.78
Adj. Flow (vph)	14	1	65	220	1	441	200	2579	147	249	1823	15
Shared Lane Traffic (%)												
Lane Group Flow (vph)	0	15	65	0	221	441	200	2579	147	249	1823	15
Enter Blocked Intersection	No	No	No	No	No	No	No	No	No	No	No	No
Lane Alignment	Left	Left	Right	Left	Left	Right	Left	Left	Right	Left	Left	Right
Median Width(ft)		0			0			12			12	
Link Offset(ft)		0			0			0			0	
Crosswalk Width(ft)		16			16			16			16	
Two way Left Turn Lane												
Headway Factor	1.00	1.00	1.00	1.00	1.00	1.00	1.00	1.00	1.00	1.00	1.00	1.00
Turning Speed (mph)	15		60	60		9	60		60	15		9
Number of Detectors	1	1	1	1	1	0	1	2	1	1	2	1
Detector Template	Left	Thru	Right	Left	Thru	Right	Left	Thru	Right	Left	Thru	Right
Leading Detector (ft)	20	20	20	20	20	0	20	100	20	20	100	20
Trailing Detector (ft)	0	0	0	0	0	0	0	0	0	0	0	0
Detector 1 Position(ft)	0	0	0	0	0	0	0	0	0	0	0	0
Detector 1 Size(ft)	20	20	20	20	20	20	20	6	20	20	6	20
Detector 1 Type	Cl+Ex	Cl+Ex	Cl+Ex	Cl+Ex	Cl+Ex	Cl+Ex	Cl+Ex	Cl+Ex	Cl+Ex	Cl+Ex	Cl+Ex	Cl+Ex
Detector 1 Channel												
Detector 1 Extend (s)	0.0	0.0	0.0	0.0	0.0	0.0	0.0	0.0	0.0	0.0	0.0	0.0
Detector 1 Queue (s)	0.0	0.0	0.0	0.0	0.0	0.0	0.0	0.0	0.0	0.0	0.0	0.0
Detector 1 Delay (s)	0.0	0.0	0.0	0.0	0.0	0.0	0.0	0.0	0.0	0.0	0.0	0.0
Detector 2 Position(ft)								94			94	
Detector 2 Size(ft)								6			6	
Detector 2 Type								Cl+Ex			Cl+Ex	
Detector 2 Channel												
Detector 2 Extend (s)								0.0			0.0	
Turn Type	Split	NA	pm+ov	Split	NA	pm+ov	pm+pt	NA	Perm	pm+pt	NA	Perm
Protected Phases	4	4	5	8	8	1	5	2		1	6	
Permitted Phases			4			8	2		2	6		6

Lanes, Volumes, Timings
5: 103rd Avenue & Tower Road

09/21/2023



Lane Group	EBL	EBT	EBR	WBL	WBT	WBR	NBL	NBT	NBR	SBL	SBT	SBR
Detector Phase	4	4	5	8	8	1	5	2	2	1	6	6
Switch Phase												
Minimum Initial (s)	5.0	5.0	5.0	5.0	5.0	5.0	5.0	5.0	5.0	5.0	5.0	5.0
Minimum Split (s)	11.0	11.0	11.0	11.0	11.0	10.5	11.0	23.5	23.5	10.5	23.5	23.5
Total Split (s)	12.0	12.0	16.0	28.0	28.0	18.0	16.0	62.0	62.0	18.0	64.0	64.0
Total Split (%)	10.0%	10.0%	13.3%	23.3%	23.3%	15.0%	13.3%	51.7%	51.7%	15.0%	53.3%	53.3%
Maximum Green (s)	7.0	7.0	11.0	22.5	22.5	13.0	11.0	57.0	57.0	13.0	59.0	59.0
Yellow Time (s)	3.0	3.0	3.0	3.5	3.5	3.0	3.0	3.0	3.0	3.0	3.0	3.0
All-Red Time (s)	2.0	2.0	2.0	2.0	2.0	2.0	2.0	2.0	2.0	2.0	2.0	2.0
Lost Time Adjust (s)		0.0	0.0		0.0	0.0	0.0	0.0	0.0	0.0	0.0	0.0
Total Lost Time (s)		5.0	5.0		5.5	5.0	5.0	5.0	5.0	5.0	5.0	5.0
Lead/Lag			Lead			Lead	Lead	Lag	Lag	Lead	Lag	Lag
Lead-Lag Optimize?			Yes			Yes	Yes	Yes	Yes	Yes	Yes	Yes
Vehicle Extension (s)	3.0	3.0	3.0	3.0	3.0	3.0	3.0	3.0	3.0	3.0	3.0	3.0
Recall Mode	None	None	None	None	None	None	None	Min	Min	None	Min	Min
Act Effct Green (s)		6.3	13.2		17.8	36.4	68.2	57.5	57.5	73.0	59.9	59.9
Actuated g/C Ratio		0.06	0.12		0.16	0.34	0.63	0.53	0.53	0.67	0.55	0.55
v/c Ratio		0.15	0.26		0.76	0.75	0.82	0.96	0.16	0.88	0.65	0.02
Control Delay		55.5	8.3		61.1	34.6	53.6	35.6	5.5	60.1	19.8	0.0
Queue Delay		0.0	0.0		0.0	0.0	0.0	0.0	0.0	0.0	0.0	0.0
Total Delay		55.5	8.3		61.1	34.6	53.6	35.6	5.5	60.1	19.8	0.0
LOS		E	A		E	C	D	D	A	E	B	A
Approach Delay		17.2			43.5			35.3			24.5	
Approach LOS		B			D			D			C	

Intersection Summary

Area Type:	Other
Cycle Length:	120
Actuated Cycle Length:	108.3
Natural Cycle:	100
Control Type:	Actuated-Uncoordinated
Maximum v/c Ratio:	0.96
Intersection Signal Delay:	32.1
Intersection LOS:	C
Intersection Capacity Utilization:	89.6%
ICU Level of Service:	E
Analysis Period (min):	15

Splits and Phases: 5: 103rd Avenue & Tower Road

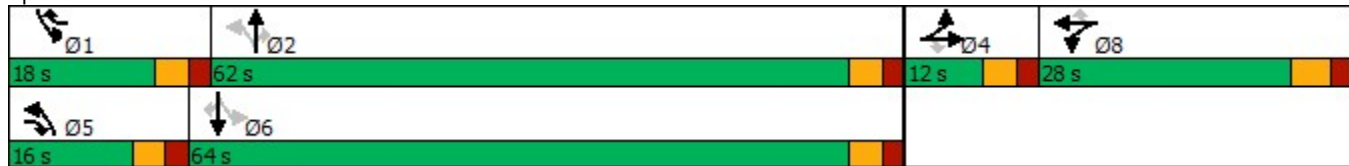

Queues

5: 103rd Avenue & Tower Road

09/21/2023

























Lane Group	EBT	EBR	WBT	WBR	NBL	NBT	NBR	SBL	SBT	SBR
Lane Group Flow (vph)	15	65	221	441	200	2579	147	249	1823	15
v/c Ratio	0.15	0.26	0.76	0.75	0.82	0.96	0.16	0.88	0.65	0.02
Control Delay	55.5	8.3	61.1	34.6	53.6	35.6	5.5	60.1	19.8	0.0
Queue Delay	0.0	0.0	0.0	0.0	0.0	0.0	0.0	0.0	0.0	0.0
Total Delay	55.5	8.3	61.1	34.6	53.6	35.6	5.5	60.1	19.8	0.0
Queue Length 50th (ft)	10	0	139	202	77	539	10	110	278	0
Queue Length 95th (ft)	30	18	209	358	#213	#900	41	#295	456	0
Internal Link Dist (ft)	795		842			348			450	
Turn Bay Length (ft)		50		100	440		185	130		
Base Capacity (vph)	115	258	371	590	250	2697	893	283	2810	925
Starvation Cap Reductn	0	0	0	0	0	0	0	0	0	0
Spillback Cap Reductn	0	0	0	0	0	0	0	0	0	0
Storage Cap Reductn	0	0	0	0	0	0	0	0	0	0
Reduced v/c Ratio	0.13	0.25	0.60	0.75	0.80	0.96	0.16	0.88	0.65	0.02

Intersection Summary

95th percentile volume exceeds capacity, queue may be longer.
 Queue shown is maximum after two cycles.

HCM 6th Signalized Intersection Summary
 5: 103rd Avenue & Tower Road

09/21/2023

												
Movement	EBL	EBT	EBR	WBL	WBT	WBR	NBL	NBT	NBR	SBL	SBT	SBR
Lane Configurations												
Traffic Volume (veh/h)	11	1	51	191	1	388	168	2450	122	217	1695	12
Future Volume (veh/h)	11	1	51	191	1	388	168	2450	122	217	1695	12
Initial Q (Qb), veh	0	0	0	0	0	0	0	0	0	0	0	0
Ped-Bike Adj(A_pbT)	1.00		1.00	1.00		1.00	1.00		1.00	1.00		1.00
Parking Bus, Adj	1.00	1.00	1.00	1.00	1.00	1.00	1.00	1.00	1.00	1.00	1.00	1.00
Work Zone On Approach		No			No			No			No	
Adj Sat Flow, veh/h/ln	1870	1870	1870	1870	1870	1870	1870	1870	1870	1870	1870	1870
Adj Flow Rate, veh/h	14	1	65	220	1	441	200	2579	147	249	1823	15
Peak Hour Factor	0.78	0.78	0.78	0.87	0.78	0.88	0.84	0.95	0.83	0.87	0.93	0.78
Percent Heavy Veh, %	2	2	2	2	2	2	2	2	2	2	2	2
Cap, veh/h	85	6	195	250	1	407	271	2600	807	272	2825	877
Arrive On Green	0.05	0.05	0.05	0.14	0.14	0.14	0.07	0.51	0.51	0.12	0.55	0.55
Sat Flow, veh/h	1668	119	1585	1774	8	1585	1781	5106	1585	1781	5106	1585
Grp Volume(v), veh/h	15	0	65	221	0	441	200	2579	147	249	1823	15
Grp Sat Flow(s),veh/h/ln	1787	0	1585	1782	0	1585	1781	1702	1585	1781	1702	1585
Q Serve(g_s), s	0.9	0.0	4.2	13.6	0.0	15.8	5.9	56.1	5.6	11.3	27.8	0.5
Cycle Q Clear(g_c), s	0.9	0.0	4.2	13.6	0.0	15.8	5.9	56.1	5.6	11.3	27.8	0.5
Prop In Lane	0.93		1.00	1.00		1.00	1.00		1.00	1.00		1.00
Lane Grp Cap(c), veh/h	91	0	195	251	0	407	271	2600	807	272	2825	877
V/C Ratio(X)	0.17	0.00	0.33	0.88	0.00	1.08	0.74	0.99	0.18	0.92	0.65	0.02
Avail Cap(c_a), veh/h	112	0	213	358	0	503	317	2600	807	272	2825	877
HCM Platoon Ratio	1.00	1.00	1.00	1.00	1.00	1.00	1.00	1.00	1.00	1.00	1.00	1.00
Upstream Filter(I)	1.00	0.00	1.00	1.00	0.00	1.00	1.00	1.00	1.00	1.00	1.00	1.00
Uniform Delay (d), s/veh	50.9	0.0	44.9	47.2	0.0	41.6	18.9	27.3	14.9	36.8	17.4	11.3
Incr Delay (d2), s/veh	0.8	0.0	1.0	16.3	0.0	64.4	7.4	15.8	0.1	33.2	0.5	0.0
Initial Q Delay(d3),s/veh	0.0	0.0	0.0	0.0	0.0	0.0	0.0	0.0	0.0	0.0	0.0	0.0
%ile BackOfQ(50%),veh/ln	0.4	0.0	1.7	7.1	0.0	18.4	3.1	25.3	2.0	9.3	10.5	0.2
Unsig. Movement Delay, s/veh												
LnGrp Delay(d),s/veh	51.7	0.0	45.9	63.5	0.0	106.0	26.3	43.0	15.0	69.9	17.9	11.3
LnGrp LOS	D	A	D	E	A	F	C	D	B	E	B	B
Approach Vol, veh/h		80			662			2926			2087	
Approach Delay, s/veh		47.0			91.8			40.5			24.1	
Approach LOS		D			F			D			C	
Timer - Assigned Phs	1	2		4	5	6		8				
Phs Duration (G+Y+Rc), s	18.0	62.0		10.7	13.1	66.9		21.3				
Change Period (Y+Rc), s	5.0	5.0		5.0	5.0	5.0		5.5				
Max Green Setting (Gmax), s	13.0	57.0		7.0	11.0	59.0		22.5				
Max Q Clear Time (g_c+I1), s	13.3	58.1		6.2	7.9	29.8		15.6				
Green Ext Time (p_c), s	0.0	0.0		0.0	0.2	17.6		0.1				
Intersection Summary												
HCM 6th Ctrl Delay			40.5									
HCM 6th LOS			D									

Lanes, Volumes, Timings
1: Walden Street & 104th Avenue

10/03/2023

Lane Group	EBL	EBT	EBR	WBL	WBT	WBR	NBL	NBT	NBR	SBL	SBT	SBR
Lane Configurations												
Traffic Volume (vph)	135	1483	100	21	722	139	183	47	83	343	41	144
Future Volume (vph)	135	1483	100	21	722	139	183	47	83	343	41	144
Ideal Flow (vphpl)	1900	1900	1900	1900	1900	1900	1900	1900	1900	1900	1900	1900
Storage Length (ft)	400		230	0		250	230		230	210		140
Storage Lanes	1		1	1		1	1		1	1		1
Taper Length (ft)	25			25			25			25		
Lane Util. Factor	1.00	0.95	1.00	1.00	0.95	1.00	1.00	1.00	1.00	1.00	1.00	1.00
Frt			0.850			0.850			0.850			0.850
Flt Protected	0.950			0.950			0.950			0.950		
Satd. Flow (prot)	1770	3539	1583	1770	3539	1583	1770	1863	1583	1770	1863	1583
Flt Permitted	0.225			0.082			0.722			0.442		
Satd. Flow (perm)	419	3539	1583	153	3539	1583	1345	1863	1583	823	1863	1583
Right Turn on Red			Yes			Yes			Yes			Yes
Satd. Flow (RTOR)			218			218			227			173
Link Speed (mph)		45			45			30				30
Link Distance (ft)		149			767			699				204
Travel Time (s)		2.3			11.6			15.9				4.6
Peak Hour Factor	0.84	0.93	0.83	0.78	0.92	0.84	0.84	0.78	0.80	0.88	0.78	0.83
Adj. Flow (vph)	161	1595	120	27	785	165	218	60	104	390	53	173
Shared Lane Traffic (%)												
Lane Group Flow (vph)	161	1595	120	27	785	165	218	60	104	390	53	173
Enter Blocked Intersection	No	No	No	No	No	No	No	No	No	No	No	No
Lane Alignment	Left	Left	Right	Left	Left	Right	Left	Left	Right	Left	Left	Right
Median Width(ft)		12			12			12				12
Link Offset(ft)		0			0			0				0
Crosswalk Width(ft)		16			16			16				16
Two way Left Turn Lane												
Headway Factor	1.00	1.00	1.00	1.00	1.00	1.00	1.00	1.00	1.00	1.00	1.00	1.00
Turning Speed (mph)	15		9	15		9	15		9	15		9
Number of Detectors	1	2	1	1	2	1	1	2	1	1	2	1
Detector Template	Left	Thru	Right	Left	Thru	Right	Left	Thru	Right	Left	Thru	Right
Leading Detector (ft)	20	100	20	20	100	20	20	100	20	20	100	20
Trailing Detector (ft)	0	0	0	0	0	0	0	0	0	0	0	0
Detector 1 Position(ft)	0	0	0	0	0	0	0	0	0	0	0	0
Detector 1 Size(ft)	20	6	20	20	6	20	20	6	20	20	6	20
Detector 1 Type	Cl+Ex	Cl+Ex	Cl+Ex	Cl+Ex	Cl+Ex	Cl+Ex	Cl+Ex	Cl+Ex	Cl+Ex	Cl+Ex	Cl+Ex	Cl+Ex
Detector 1 Channel												
Detector 1 Extend (s)	0.0	0.0	0.0	0.0	0.0	0.0	0.0	0.0	0.0	0.0	0.0	0.0
Detector 1 Queue (s)	0.0	0.0	0.0	0.0	0.0	0.0	0.0	0.0	0.0	0.0	0.0	0.0
Detector 1 Delay (s)	0.0	0.0	0.0	0.0	0.0	0.0	0.0	0.0	0.0	0.0	0.0	0.0
Detector 2 Position(ft)		94			94			94				94
Detector 2 Size(ft)		6			6			6				6
Detector 2 Type		Cl+Ex			Cl+Ex			Cl+Ex				Cl+Ex
Detector 2 Channel												
Detector 2 Extend (s)		0.0			0.0			0.0				0.0
Turn Type	pm+pt	NA	Perm	pm+pt	NA	Perm	pm+pt	NA	Perm	pm+pt	NA	Perm
Protected Phases	5	2		1	6		3	8		7	4	
Permitted Phases	2		2	6		6	8		8	4		4

Lanes, Volumes, Timings
1: Walden Street & 104th Avenue

10/03/2023

Lane Group	EBL	EBT	EBR	WBL	WBT	WBR	NBL	NBT	NBR	SBL	SBT	SBR
Detector Phase	5	2	2	1	6	6	3	8	8	7	4	4
Switch Phase												
Minimum Initial (s)	5.0	10.0	10.0	5.0	10.0	10.0	8.0	10.0	10.0	8.0	10.0	10.0
Minimum Split (s)	12.5	17.5	17.5	12.5	17.5	17.5	14.5	16.5	16.5	14.5	16.5	16.5
Total Split (s)	17.8	53.3	53.3	12.5	48.0	48.0	21.0	25.5	25.5	28.7	33.2	33.2
Total Split (%)	14.8%	44.4%	44.4%	10.4%	40.0%	40.0%	17.5%	21.3%	21.3%	23.9%	27.7%	27.7%
Maximum Green (s)	10.3	45.8	45.8	5.0	40.5	40.5	14.5	19.0	19.0	22.2	26.7	26.7
Yellow Time (s)	5.3	5.3	5.3	5.3	5.3	5.3	3.8	3.8	3.8	3.8	3.8	3.8
All-Red Time (s)	2.2	2.2	2.2	2.2	2.2	2.2	2.7	2.7	2.7	2.7	2.7	2.7
Lost Time Adjust (s)	0.0	0.0	0.0	0.0	0.0	0.0	0.0	0.0	0.0	0.0	0.0	0.0
Total Lost Time (s)	7.5	7.5	7.5	7.5	7.5	7.5	6.5	6.5	6.5	6.5	6.5	6.5
Lead/Lag	Lead	Lag	Lag	Lead	Lag	Lag	Lead	Lag	Lag	Lead	Lag	Lag
Lead-Lag Optimize?	Yes	Yes	Yes	Yes	Yes	Yes	Yes	Yes	Yes	Yes	Yes	Yes
Vehicle Extension (s)	3.0	5.0	5.0	3.0	5.0	5.0	2.0	2.0	2.0	2.0	2.0	2.0
Recall Mode	None	C-Max	C-Max	None	C-Max	C-Max	None	None	None	None	None	None
Act Effct Green (s)	66.3	58.8	58.8	55.4	49.1	49.1	23.8	10.3	10.3	38.6	18.6	18.6
Actuated g/C Ratio	0.55	0.49	0.49	0.46	0.41	0.41	0.20	0.09	0.09	0.32	0.16	0.16
v/c Ratio	0.46	0.92	0.14	0.17	0.54	0.21	0.69	0.38	0.30	0.90	0.18	0.44
Control Delay	17.3	39.6	0.3	15.7	29.3	1.7	45.4	58.7	2.3	60.3	46.1	10.4
Queue Delay	0.0	0.0	0.0	0.0	0.0	0.0	0.0	0.0	0.0	0.0	0.0	0.0
Total Delay	17.3	39.6	0.3	15.7	29.3	1.7	45.4	58.7	2.3	60.3	46.1	10.4
LOS	B	D	A	B	C	A	D	E	A	E	D	B
Approach Delay		35.2			24.3			35.7			45.0	
Approach LOS		D			C			D			D	

Intersection Summary

Area Type:	Other
Cycle Length:	120
Actuated Cycle Length:	120
Offset:	0 (0%), Referenced to phase 2:EBTL and 6:WBTL, Start of Yellow
Natural Cycle:	110
Control Type:	Actuated-Coordinated
Maximum v/c Ratio:	0.92
Intersection Signal Delay:	34.0
Intersection LOS:	C
Intersection Capacity Utilization:	88.7%
ICU Level of Service:	E
Analysis Period (min):	15

Splits and Phases: 1: Walden Street & 104th Avenue



Queues

1: Walden Street & 104th Avenue

10/03/2023

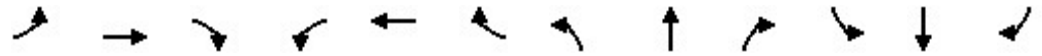

Lane Group	EBL	EBT	EBR	WBL	WBT	WBR	NBL	NBT	NBR	SBL	SBT	SBR
Lane Group Flow (vph)	161	1595	120	27	785	165	218	60	104	390	53	173
v/c Ratio	0.46	0.92	0.14	0.17	0.54	0.21	0.69	0.38	0.30	0.90	0.18	0.44
Control Delay	17.3	39.6	0.3	15.7	29.3	1.7	45.4	58.7	2.3	60.3	46.1	10.4
Queue Delay	0.0	0.0	0.0	0.0	0.0	0.0	0.0	0.0	0.0	0.0	0.0	0.0
Total Delay	17.3	39.6	0.3	15.7	29.3	1.7	45.4	58.7	2.3	60.3	46.1	10.4
Queue Length 50th (ft)	57	~655	0	9	239	0	130	45	0	262	36	0
Queue Length 95th (ft)	89	#860	0	20	325	9	181	76	0	#408	64	47
Internal Link Dist (ft)		69			687			619			124	
Turn Bay Length (ft)	400		230			250	230		230	210		140
Base Capacity (vph)	361	1735	887	156	1447	776	329	294	441	439	414	486
Starvation Cap Reductn	0	0	0	0	0	0	0	0	0	0	0	0
Spillback Cap Reductn	0	0	0	0	0	0	0	0	0	0	0	0
Storage Cap Reductn	0	0	0	0	0	0	0	0	0	0	0	0
Reduced v/c Ratio	0.45	0.92	0.14	0.17	0.54	0.21	0.66	0.20	0.24	0.89	0.13	0.36

























Intersection Summary

- ~ Volume exceeds capacity, queue is theoretically infinite.
Queue shown is maximum after two cycles.
- # 95th percentile volume exceeds capacity, queue may be longer.
Queue shown is maximum after two cycles.

HCM 6th Signalized Intersection Summary

1: Walden Street & 104th Avenue

10/03/2023

												
Movement	EBL	EBT	EBR	WBL	WBT	WBR	NBL	NBT	NBR	SBL	SBT	SBR
Lane Configurations												
Traffic Volume (veh/h)	135	1483	100	21	722	139	183	47	83	343	41	144
Future Volume (veh/h)	135	1483	100	21	722	139	183	47	83	343	41	144
Initial Q (Qb), veh	0	0	0	0	0	0	0	0	0	0	0	0
Ped-Bike Adj(A_pbT)	1.00		1.00	1.00		1.00	1.00		1.00	1.00		1.00
Parking Bus, Adj	1.00	1.00	1.00	1.00	1.00	1.00	1.00	1.00	1.00	1.00	1.00	1.00
Work Zone On Approach		No			No			No			No	
Adj Sat Flow, veh/h/ln	1870	1870	1870	1870	1870	1870	1870	1870	1870	1870	1870	1870
Adj Flow Rate, veh/h	161	1595	120	27	785	165	218	60	104	390	53	173
Peak Hour Factor	0.84	0.93	0.83	0.78	0.92	0.84	0.84	0.78	0.80	0.88	0.78	0.83
Percent Heavy Veh, %	2	2	2	2	2	2	2	2	2	2	2	2
Cap, veh/h	339	1683	751	117	1533	684	371	156	132	454	276	234
Arrive On Green	0.07	0.47	0.47	0.02	0.43	0.43	0.12	0.08	0.08	0.19	0.15	0.15
Sat Flow, veh/h	1781	3554	1585	1781	3554	1585	1781	1870	1585	1781	1870	1585
Grp Volume(v), veh/h	161	1595	120	27	785	165	218	60	104	390	53	173
Grp Sat Flow(s),veh/h/ln	1781	1777	1585	1781	1777	1585	1781	1870	1585	1781	1870	1585
Q Serve(g_s), s	6.0	51.4	5.2	1.0	19.3	7.9	13.3	3.6	7.7	22.2	3.0	12.5
Cycle Q Clear(g_c), s	6.0	51.4	5.2	1.0	19.3	7.9	13.3	3.6	7.7	22.2	3.0	12.5
Prop In Lane	1.00		1.00	1.00		1.00	1.00		1.00	1.00		1.00
Lane Grp Cap(c), veh/h	339	1683	751	117	1533	684	371	156	132	454	276	234
V/C Ratio(X)	0.48	0.95	0.16	0.23	0.51	0.24	0.59	0.38	0.79	0.86	0.19	0.74
Avail Cap(c_a), veh/h	372	1683	751	147	1533	684	371	296	251	454	416	353
HCM Platoon Ratio	1.00	1.00	1.00	1.00	1.00	1.00	1.00	1.00	1.00	1.00	1.00	1.00
Upstream Filter(I)	1.00	1.00	1.00	1.00	1.00	1.00	1.00	1.00	1.00	1.00	1.00	1.00
Uniform Delay (d), s/veh	18.7	30.2	18.0	27.9	24.9	21.7	43.3	52.1	54.0	40.0	44.9	48.9
Incr Delay (d2), s/veh	1.0	12.6	0.5	1.0	1.2	0.8	1.6	0.6	3.9	14.5	0.1	1.7
Initial Q Delay(d3),s/veh	0.0	0.0	0.0	0.0	0.0	0.0	0.0	0.0	0.0	0.0	0.0	0.0
%ile BackOfQ(50%),veh/ln	2.4	23.2	2.0	0.4	8.0	3.1	6.0	1.7	3.2	12.3	1.4	5.1
Unsig. Movement Delay, s/veh												
LnGrp Delay(d),s/veh	19.8	42.8	18.4	28.9	26.1	22.5	44.9	52.7	57.8	54.5	45.0	50.7
LnGrp LOS	B	D	B	C	C	C	D	D	E	D	D	D
Approach Vol, veh/h		1876			977			382				616
Approach Delay, s/veh		39.2			25.6			49.7				52.6
Approach LOS		D			C			D				D
Timer - Assigned Phs	1	2	3	4	5	6	7	8				
Phs Duration (G+Y+Rc), s	10.5	64.3	21.0	24.2	15.5	59.3	28.7	16.5				
Change Period (Y+Rc), s	* 7.5	* 7.5	6.5	6.5	* 7.5	* 7.5	6.5	6.5				
Max Green Setting (Gmax), s	* 5	* 46	14.5	26.7	* 10	* 41	22.2	19.0				
Max Q Clear Time (g_c+I1), s	3.0	53.4	15.3	14.5	8.0	21.3	24.2	9.7				
Green Ext Time (p_c), s	0.0	0.0	0.0	0.4	0.1	9.5	0.0	0.2				
Intersection Summary												
HCM 6th Ctrl Delay											38.9	
HCM 6th LOS											D	
Notes												
* HCM 6th computational engine requires equal clearance times for the phases crossing the barrier.												

Lanes, Volumes, Timings
2: Yampa Street & 104th Avenue

10/03/2023



Lane Group	EBT	EBR	WBL	WBT	NBL	NBR
Lane Configurations	↑↑↑↑	↗	↖	↑↑↑↑		↗
Traffic Volume (vph)	1864	59	35	903	0	28
Future Volume (vph)	1864	59	35	903	0	28
Ideal Flow (vphpl)	1900	1900	1900	1900	1900	1900
Storage Length (ft)		50	50		0	0
Storage Lanes		1	1		0	1
Taper Length (ft)			25		25	
Lane Util. Factor	0.91	1.00	1.00	0.91	1.00	1.00
Frt		0.850				0.865
Flt Protected			0.950			
Satd. Flow (prot)	5085	1583	1770	5085	0	1611
Flt Permitted			0.950			
Satd. Flow (perm)	5085	1583	1770	5085	0	1611
Link Speed (mph)	35			45	30	
Link Distance (ft)	767			1110	440	
Travel Time (s)	14.9			16.8	10.0	
Peak Hour Factor	0.93	0.78	0.78	0.92	0.78	0.78
Adj. Flow (vph)	2004	76	45	982	0	36
Shared Lane Traffic (%)						
Lane Group Flow (vph)	2004	76	45	982	0	36
Enter Blocked Intersection	No	No	No	No	No	No
Lane Alignment	Left	Right	Left	Left	Left	Right
Median Width(ft)	24			24	0	
Link Offset(ft)	0			0	0	
Crosswalk Width(ft)	16			16	16	
Two way Left Turn Lane						
Headway Factor	1.00	1.00	1.00	1.00	1.00	1.00
Turning Speed (mph)		9	15		15	9
Sign Control	Free			Free	Stop	

Intersection Summary

Area Type:	Other
Control Type:	Unsignalized
Intersection Capacity Utilization	46.0%
	ICU Level of Service A
Analysis Period (min)	15

Intersection						
Int Delay, s/veh	1.1					
Movement	EBT	EBR	WBL	WBT	NBL	NBR
Lane Configurations	↑↑↑	↑	↑	↑↑↑		↑
Traffic Vol, veh/h	1864	59	35	903	0	28
Future Vol, veh/h	1864	59	35	903	0	28
Conflicting Peds, #/hr	0	0	0	0	0	0
Sign Control	Free	Free	Free	Free	Stop	Stop
RT Channelized	-	None	-	None	-	None
Storage Length	-	50	50	-	-	0
Veh in Median Storage, #	0	-	-	0	0	-
Grade, %	0	-	-	0	0	-
Peak Hour Factor	93	78	78	92	78	78
Heavy Vehicles, %	2	2	2	2	2	2
Mvmt Flow	2004	76	45	982	0	36





































Major/Minor	Major1	Major2	Minor1	Minor2	Minor3
Conflicting Flow All	0	0	2080	0	1002
Stage 1	-	-	-	-	-
Stage 2	-	-	-	-	-
Critical Hdwy	-	-	5.34	-	7.14
Critical Hdwy Stg 1	-	-	-	-	-
Critical Hdwy Stg 2	-	-	-	-	-
Follow-up Hdwy	-	-	3.12	-	3.92
Pot Cap-1 Maneuver	-	-	114	-	207
Stage 1	-	-	-	-	0
Stage 2	-	-	-	-	0
Platoon blocked, %	-	-	-	-	-
Mov Cap-1 Maneuver	-	-	114	-	207
Mov Cap-2 Maneuver	-	-	-	-	-
Stage 1	-	-	-	-	-
Stage 2	-	-	-	-	-

Approach	EB	WB	NB
HCM Control Delay, s	0	2.4	26
HCM LOS			D

Minor Lane/Major Mvmt	NBLn1	EBT	EBR	WBL	WBT
Capacity (veh/h)	207	-	-	114	-
HCM Lane V/C Ratio	0.173	-	-	0.394	-
HCM Control Delay (s)	26	-	-	55.7	-
HCM Lane LOS	D	-	-	F	-
HCM 95th %tile Q(veh)	0.6	-	-	1.6	-

Lanes, Volumes, Timings
3: Tower Road & 104th Avenue

10/03/2023

												
Lane Group	EBL	EBT	EBR	WBL	WBT	WBR	NBL	NBT	NBR	SBL	SBT	SBR
Lane Configurations	 	  		 	  		 	  		 	  	 
Traffic Volume (vph)	197	556	884	56	191	10	444	873	92	22	1168	159
Future Volume (vph)	197	556	884	56	191	10	444	873	92	22	1168	159
Ideal Flow (vphpl)	1900	1900	1900	1900	1900	1900	1900	1900	1900	1900	1900	1900
Storage Length (ft)	350		590	330		440	320		290	290		190
Storage Lanes	2		1	2		1	2		1	2		1
Taper Length (ft)	25			25			25			25		
Lane Util. Factor	0.97	0.91	1.00	0.97	0.91	1.00	0.97	0.91	1.00	0.97	0.91	1.00
Frt			0.850			0.850			0.850			0.850
Flt Protected	0.950			0.950			0.950			0.950		
Satd. Flow (prot)	3433	5085	1583	3433	5085	1583	3433	5085	1583	3433	5085	1583
Flt Permitted	0.950			0.950			0.950			0.950		
Satd. Flow (perm)	3433	5085	1583	3433	5085	1583	3433	5085	1583	3433	5085	1583
Right Turn on Red			Yes			Yes			Yes			Yes
Satd. Flow (RTOR)			292			268			260			260
Link Speed (mph)		45			45			50			50	
Link Distance (ft)		1110			840			620			1000	
Travel Time (s)		16.8			12.7			8.5			13.6	
Peak Hour Factor	0.87	0.92	0.92	0.78	0.87	0.78	0.88	0.92	0.80	0.78	0.93	0.84
Adj. Flow (vph)	226	604	961	72	220	13	505	949	115	28	1256	189
Shared Lane Traffic (%)												
Lane Group Flow (vph)	226	604	961	72	220	13	505	949	115	28	1256	189
Enter Blocked Intersection	No	No	No	No	No	No	No	No	No	No	No	No
Lane Alignment	Left	Left	Right	Left	Left	Right	Left	Left	Right	Left	Left	Right
Median Width(ft)		24			24			24			24	
Link Offset(ft)		0			0			0			0	
Crosswalk Width(ft)		16			16			16			16	
Two way Left Turn Lane												
Headway Factor	1.00	1.00	1.00	1.00	1.00	1.00	1.00	1.00	1.00	1.00	1.00	1.00
Turning Speed (mph)	15		9	15		9	15		9	15		9
Number of Detectors	1	1	1	1	1	1	1	1	1	1	1	1
Detector Template	Left	Thru	Right	Left	Thru	Right	Left	Thru	Right	Left	Thru	Right
Leading Detector (ft)	40	40	40	40	40	40	40	40	40	40	40	40
Trailing Detector (ft)	0	0	0	0	0	0	0	0	0	0	0	0
Detector 1 Position(ft)	0	0	0	0	0	0	0	0	0	0	0	0
Detector 1 Size(ft)	40	40	40	40	40	40	40	40	40	40	40	40
Detector 1 Type	Cl+Ex	Cl+Ex	Cl+Ex	Cl+Ex	Cl+Ex	Cl+Ex	Cl+Ex	Cl+Ex	Cl+Ex	Cl+Ex	Cl+Ex	Cl+Ex
Detector 1 Channel												
Detector 1 Extend (s)	0.0	0.0	0.0	0.0	0.0	0.0	0.0	0.0	0.0	0.0	0.0	0.0
Detector 1 Queue (s)	0.0	0.0	0.0	0.0	0.0	0.0	0.0	0.0	0.0	0.0	0.0	0.0
Detector 1 Delay (s)	0.0	0.0	0.0	0.0	0.0	0.0	0.0	0.0	0.0	0.0	0.0	0.0
Turn Type	Prot	NA	Perm	Prot	NA	Perm	Prot	NA	Perm	Prot	NA	Perm
Protected Phases	7	4		3	8		5	2		1	6	
Permitted Phases			4			8			2			6
Detector Phase	7	4	4	3	8	8	5	2	2	1	6	6
Switch Phase												
Minimum Initial (s)	3.6	2.0	2.0	3.6	10.0	10.0	8.0	10.0	10.0	8.0	10.0	10.0
Minimum Split (s)	11.0	11.0	11.0	11.0	20.0	20.0	16.2	34.0	34.0	16.2	19.0	19.0
Total Split (s)	21.0	47.0	47.0	12.0	38.0	38.0	24.0	38.0	38.0	18.0	32.0	32.0

Lanes, Volumes, Timings
 3: Tower Road & 104th Avenue

10/03/2023



Lane Group	EBL	EBT	EBR	WBL	WBT	WBR	NBL	NBT	NBR	SBL	SBT	SBR
Total Split (%)	18.3%	40.9%	40.9%	10.4%	33.0%	33.0%	20.9%	33.0%	33.0%	15.7%	27.8%	27.8%
Maximum Green (s)	13.6	39.6	39.6	4.6	30.6	30.6	15.8	29.8	29.8	9.8	23.8	23.8
Yellow Time (s)	5.0	5.0	5.0	5.0	5.0	5.0	5.1	5.1	5.1	5.1	5.1	5.1
All-Red Time (s)	2.4	2.4	2.4	2.4	2.4	2.4	3.1	3.1	3.1	3.1	3.1	3.1
Lost Time Adjust (s)	0.0	0.0	0.0	0.0	0.0	0.0	0.0	0.0	0.0	0.0	0.0	0.0
Total Lost Time (s)	7.4	7.4	7.4	7.4	7.4	7.4	8.2	8.2	8.2	8.2	8.2	8.2
Lead/Lag	Lead	Lag	Lag	Lead	Lag	Lag	Lead	Lag	Lag	Lead	Lag	Lag
Lead-Lag Optimize?	Yes	Yes	Yes	Yes	Yes	Yes	Yes	Yes	Yes	Yes	Yes	Yes
Vehicle Extension (s)	2.0	2.0	2.0	2.0	2.0	2.0	2.0	5.0	5.0	2.0	5.0	5.0
Recall Mode	None	None	None	None	None	None	None	C-Min	C-Min	None	C-Min	C-Min
Act Effct Green (s)	11.5	42.0	42.0	4.6	32.7	32.7	15.8	38.1	38.1	8.0	23.8	23.8
Actuated g/C Ratio	0.10	0.37	0.37	0.04	0.28	0.28	0.14	0.33	0.33	0.07	0.21	0.21
v/c Ratio	0.66	0.33	1.26	0.53	0.15	0.02	1.07	0.56	0.16	0.12	1.19	0.35
Control Delay	59.1	27.6	151.4	68.2	31.7	0.1	109.3	34.6	0.5	51.5	136.9	2.9
Queue Delay	0.0	0.0	0.0	0.0	0.0	0.0	0.0	0.0	0.0	0.0	0.0	0.0
Total Delay	59.1	27.6	151.4	68.2	31.7	0.1	109.3	34.6	0.5	51.5	136.9	2.9
LOS	E	C	F	E	C	A	F	C	A	D	F	A
Approach Delay		98.0			38.9			56.1			118.1	
Approach LOS		F			D			E			F	

Intersection Summary

Area Type: Other
 Cycle Length: 115
 Actuated Cycle Length: 115
 Offset: 0 (0%), Referenced to phase 2:NBT and 6:SBT, Start of Yellow, Master Intersection
 Natural Cycle: 145
 Control Type: Actuated-Coordinated
 Maximum v/c Ratio: 1.26
 Intersection Signal Delay: 87.5
 Intersection LOS: F
 Intersection Capacity Utilization 99.8%
 ICU Level of Service F
 Analysis Period (min) 15

Splits and Phases: 3: Tower Road & 104th Avenue

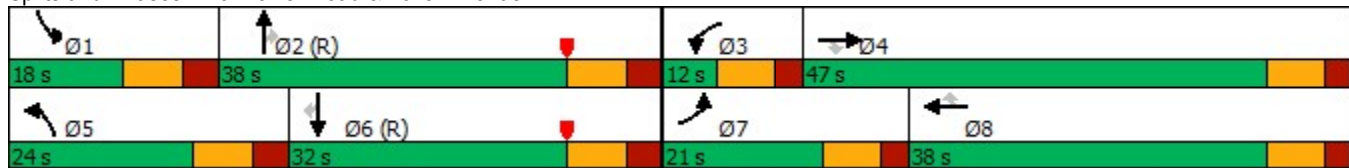

Queues

3: Tower Road & 104th Avenue

10/03/2023



Lane Group	EBL	EBT	EBR	WBL	WBT	WBR	NBL	NBT	NBR	SBL	SBT	SBR
Lane Group Flow (vph)	226	604	961	72	220	13	505	949	115	28	1256	189
v/c Ratio	0.66	0.33	1.26	0.53	0.15	0.02	1.07	0.56	0.16	0.12	1.19	0.35
Control Delay	59.1	27.6	151.4	68.2	31.7	0.1	109.3	34.6	0.5	51.5	136.9	2.9
Queue Delay	0.0	0.0	0.0	0.0	0.0	0.0	0.0	0.0	0.0	0.0	0.0	0.0
Total Delay	59.1	27.6	151.4	68.2	31.7	0.1	109.3	34.6	0.5	51.5	136.9	2.9
Queue Length 50th (ft)	84	120	~767	27	44	0	~213	229	0	10	~412	0
Queue Length 95th (ft)	119	154	#1019	45	65	0	#310	279	0	22	#507	3
Internal Link Dist (ft)		1030			760			540			920	
Turn Bay Length (ft)	350		590	330		440	320		290	290		190
Base Capacity (vph)	405	1857	763	137	1445	641	471	1683	697	292	1052	533
Starvation Cap Reductn	0	0	0	0	0	0	0	0	0	0	0	0
Spillback Cap Reductn	0	0	0	0	0	0	0	0	0	0	0	0
Storage Cap Reductn	0	0	0	0	0	0	0	0	0	0	0	0
Reduced v/c Ratio	0.56	0.33	1.26	0.53	0.15	0.02	1.07	0.56	0.16	0.10	1.19	0.35

Intersection Summary

- ~ Volume exceeds capacity, queue is theoretically infinite.
Queue shown is maximum after two cycles.
- # 95th percentile volume exceeds capacity, queue may be longer.
Queue shown is maximum after two cycles.

HCM 6th Signalized Intersection Summary
 3: Tower Road & 104th Avenue

10/03/2023



Movement	EBL	EBT	EBR	WBL	WBT	WBR	NBL	NBT	NBR	SBL	SBT	SBR
Lane Configurations	↖↗	↑↑↑	↖	↖↗	↑↑↑	↖	↖↗	↑↑↑	↖	↖↗	↑↑↑	↖
Traffic Volume (veh/h)	197	556	884	56	191	10	444	873	92	22	1168	159
Future Volume (veh/h)	197	556	884	56	191	10	444	873	92	22	1168	159
Initial Q (Qb), veh	0	0	0	0	0	0	0	0	0	0	0	0
Ped-Bike Adj(A_pbT)	1.00		1.00	1.00		1.00	1.00		1.00	1.00		1.00
Parking Bus, Adj	1.00	1.00	1.00	1.00	1.00	1.00	1.00	1.00	1.00	1.00	1.00	1.00
Work Zone On Approach		No			No			No			No	
Adj Sat Flow, veh/h/ln	1870	1870	1870	1870	1870	1870	1870	1870	1870	1870	1870	1870
Adj Flow Rate, veh/h	226	604	0	72	220	0	505	949	0	28	1256	0
Peak Hour Factor	0.87	0.92	0.92	0.78	0.87	0.78	0.88	0.92	0.80	0.78	0.93	0.84
Percent Heavy Veh, %	2	2	2	2	2	2	2	2	2	2	2	2
Cap, veh/h	287	737		118	487		475	2600		142	2108	
Arrive On Green	0.08	0.14	0.00	0.03	0.10	0.00	0.14	0.51	0.00	0.04	0.41	0.00
Sat Flow, veh/h	3456	5106	1585	3456	5106	1585	3456	5106	1585	3456	5106	1585
Grp Volume(v), veh/h	226	604	0	72	220	0	505	949	0	28	1256	0
Grp Sat Flow(s),veh/h/ln	1728	1702	1585	1728	1702	1585	1728	1702	1585	1728	1702	1585
Q Serve(g_s), s	7.4	13.2	0.0	2.4	4.7	0.0	15.8	12.9	0.0	0.9	22.0	0.0
Cycle Q Clear(g_c), s	7.4	13.2	0.0	2.4	4.7	0.0	15.8	12.9	0.0	0.9	22.0	0.0
Prop In Lane	1.00		1.00	1.00		1.00	1.00		1.00	1.00		1.00
Lane Grp Cap(c), veh/h	287	737		118	487		475	2600		142	2108	
V/C Ratio(X)	0.79	0.82		0.61	0.45		1.06	0.37		0.20	0.60	
Avail Cap(c_a), veh/h	409	1758		138	1359		475	2600		294	2108	
HCM Platoon Ratio	1.00	1.00	1.00	1.00	1.00	1.00	1.00	1.00	1.00	1.00	1.00	1.00
Upstream Filter(l)	1.00	1.00	0.00	1.00	1.00	0.00	1.00	1.00	0.00	1.00	1.00	0.00
Uniform Delay (d), s/veh	51.7	47.8	0.0	54.8	49.2	0.0	49.6	17.0	0.0	53.3	26.3	0.0
Incr Delay (d2), s/veh	3.9	0.9	0.0	2.8	0.2	0.0	59.3	0.4	0.0	0.2	1.3	0.0
Initial Q Delay(d3),s/veh	0.0	0.0	0.0	0.0	0.0	0.0	0.0	0.0	0.0	0.0	0.0	0.0
%ile BackOfQ(50%),veh/ln	3.3	5.5	0.0	1.0	2.0	0.0	10.4	4.7	0.0	0.4	8.6	0.0
Unsig. Movement Delay, s/veh												
LnGrp Delay(d),s/veh	55.7	48.6	0.0	57.6	49.4	0.0	108.9	17.4	0.0	53.5	27.5	0.0
LnGrp LOS	E	D		E	D		F	B		D	C	
Approach Vol, veh/h		830			292			1454			1284	
Approach Delay, s/veh		50.5			51.4			49.2			28.1	
Approach LOS		D			D			D			C	
Timer - Assigned Phs	1	2	3	4	5	6	7	8				
Phs Duration (G+Y+Rc), s	12.9	66.7	11.3	24.0	24.0	55.7	17.0	18.4				
Change Period (Y+Rc), s	8.2	8.2	7.4	7.4	8.2	8.2	7.4	7.4				
Max Green Setting (Gmax), s	9.8	29.8	4.6	39.6	15.8	23.8	13.6	30.6				
Max Q Clear Time (g_c+I1), s	2.9	14.9	4.4	15.2	17.8	24.0	9.4	6.7				
Green Ext Time (p_c), s	0.0	6.9	0.0	1.4	0.0	0.0	0.2	0.5				

Intersection Summary

HCM 6th Ctrl Delay	42.6
HCM 6th LOS	D

Notes

User approved pedestrian interval to be less than phase max green.
 Unsignalized Delay for [NBR, EBR, WBR, SBR] is excluded from calculations of the approach delay and intersection delay.

Lanes, Volumes, Timings
4: Tower Road & Private Access

10/03/2023



Lane Group	EBL	EBR	NBL	NBT	SBT	SBR
Lane Configurations		↗		↑↑	↑↑↗	
Traffic Volume (vph)	0	37	0	1398	1403	136
Future Volume (vph)	0	37	0	1398	1403	136
Ideal Flow (vphpl)	1900	1900	1900	1900	1900	1900
Lane Util. Factor	1.00	1.00	1.00	0.95	0.91	0.91
Fr _t		0.865			0.985	
Fl _t Protected						
Satd. Flow (prot)	0	1611	0	3539	5009	0
Fl _t Permitted						
Satd. Flow (perm)	0	1611	0	3539	5009	0
Link Speed (mph)	30			50	30	
Link Distance (ft)	345			530	620	
Travel Time (s)	7.8			7.2	14.1	
Peak Hour Factor	0.78	0.78	0.78	0.93	0.93	0.84
Adj. Flow (vph)	0	47	0	1503	1509	162
Shared Lane Traffic (%)						
Lane Group Flow (vph)	0	47	0	1503	1671	0
Enter Blocked Intersection	No	No	No	No	No	No
Lane Alignment	Left	Right	Left	Left	Left	Right
Median Width(ft)	0			24	24	
Link Offset(ft)	0			0	0	
Crosswalk Width(ft)	16			16	16	
Two way Left Turn Lane						
Headway Factor	1.00	1.00	1.00	1.00	1.00	1.00
Turning Speed (mph)	15	9	15			9
Sign Control	Stop			Free	Free	

Intersection Summary

Area Type:	Other
Control Type:	Unsignalized
Intersection Capacity Utilization	42.0%
ICU Level of Service	A
Analysis Period (min)	15

Intersection						
Int Delay, s/veh	0.3					
Movement	EBL	EBR	NBL	NBT	SBT	SBR
Lane Configurations		↗		↑↑	↑↑↑	
Traffic Vol, veh/h	0	37	0	1398	1403	136
Future Vol, veh/h	0	37	0	1398	1403	136
Conflicting Peds, #/hr	0	0	0	0	0	0
Sign Control	Stop	Stop	Free	Free	Free	Free
RT Channelized	-	None	-	None	-	None
Storage Length	-	0	-	-	-	-
Veh in Median Storage, #	0	-	-	0	0	-
Grade, %	0	-	-	0	0	-
Peak Hour Factor	78	78	78	93	93	84
Heavy Vehicles, %	2	2	2	2	2	2
Mvmt Flow	0	47	0	1503	1509	162























Major/Minor	Minor2	Major1	Major2		
Conflicting Flow All	-	836	-	0	-
Stage 1	-	-	-	-	-
Stage 2	-	-	-	-	-
Critical Hdwy	-	7.14	-	-	-
Critical Hdwy Stg 1	-	-	-	-	-
Critical Hdwy Stg 2	-	-	-	-	-
Follow-up Hdwy	-	3.92	-	-	-
Pot Cap-1 Maneuver	0	267	0	-	-
Stage 1	0	-	0	-	-
Stage 2	0	-	0	-	-
Platoon blocked, %				-	-
Mov Cap-1 Maneuver	-	267	-	-	-
Mov Cap-2 Maneuver	-	-	-	-	-
Stage 1	-	-	-	-	-
Stage 2	-	-	-	-	-

Approach	EB	NB	SB
HCM Control Delay, s	21.4	0	0
HCM LOS	C		

Minor Lane/Major Mvmt	NBT	EBLn1	SBT	SBR
Capacity (veh/h)	-	267	-	-
HCM Lane V/C Ratio	-	0.178	-	-
HCM Control Delay (s)	-	21.4	-	-
HCM Lane LOS	-	C	-	-
HCM 95th %tile Q(veh)	-	0.6	-	-

Lanes, Volumes, Timings
5: 103rd Avenue & Tower Road

10/03/2023

												
Lane Group	EBL	EBT	EBR	WBL	WBT	WBR	NBL	NBT	NBR	SBL	SBT	SBR
Lane Configurations												
Traffic Volume (vph)	10	1	51	80	1	205	105	1377	69	146	2142	22
Future Volume (vph)	10	1	51	80	1	205	105	1377	69	146	2142	22
Ideal Flow (vphpl)	1900	1900	1900	1900	1900	1900	1900	1900	1900	1900	1900	1900
Storage Length (ft)	45		50	100		100	440		185	130		0
Storage Lanes	0		1	0		1	1		1	1		1
Taper Length (ft)	25			25			25			25		
Lane Util. Factor	1.00	1.00	1.00	1.00	1.00	1.00	1.00	0.91	1.00	1.00	0.91	1.00
Frt			0.850			0.850			0.850			0.850
Flt Protected		0.956			0.953		0.950			0.950		
Satd. Flow (prot)	0	1781	1583	0	1775	1583	1770	5085	1583	1770	5085	1583
Flt Permitted		0.956			0.953		0.103			0.109		
Satd. Flow (perm)	0	1781	1583	0	1775	1583	192	5085	1583	203	5085	1583
Right Turn on Red			Yes			Yes			Yes			Yes
Satd. Flow (RTOR)			125			236			177			125
Link Speed (mph)		30			30			50			30	
Link Distance (ft)		875			922			428			530	
Travel Time (s)		19.9			21.0			5.8			12.0	
Peak Hour Factor	0.78	0.78	0.78	0.80	0.78	0.87	0.83	0.93	0.79	0.84	0.95	0.78
Adj. Flow (vph)	13	1	65	100	1	236	127	1481	87	174	2255	28
Shared Lane Traffic (%)												
Lane Group Flow (vph)	0	14	65	0	101	236	127	1481	87	174	2255	28
Enter Blocked Intersection	No	No	No	No	No	No	No	No	No	No	No	No
Lane Alignment	Left	Left	Right	Left	Left	Right	Left	Left	Right	Left	Left	Right
Median Width(ft)		0			0			12			12	
Link Offset(ft)		0			0			0			0	
Crosswalk Width(ft)		16			16			16			16	
Two way Left Turn Lane												
Headway Factor	1.00	1.00	1.00	1.00	1.00	1.00	1.00	1.00	1.00	1.00	1.00	1.00
Turning Speed (mph)	15		9	15		60	15		9	60		9
Number of Detectors	1	1	1	1	1	0	1	2	1	1	2	1
Detector Template	Left	Thru	Right	Left	Thru	Right	Left	Thru	Right	Left	Thru	Right
Leading Detector (ft)	20	20	20	20	20	0	20	100	20	20	100	20
Trailing Detector (ft)	0	0	0	0	0	0	0	0	0	0	0	0
Detector 1 Position(ft)	0	0	0	0	0	0	0	0	0	0	0	0
Detector 1 Size(ft)	20	20	20	20	20	20	20	6	20	20	6	20
Detector 1 Type	Cl+Ex	Cl+Ex	Cl+Ex	Cl+Ex	Cl+Ex	Cl+Ex	Cl+Ex	Cl+Ex	Cl+Ex	Cl+Ex	Cl+Ex	Cl+Ex
Detector 1 Channel												
Detector 1 Extend (s)	0.0	0.0	0.0	0.0	0.0	0.0	0.0	0.0	0.0	0.0	0.0	0.0
Detector 1 Queue (s)	0.0	0.0	0.0	0.0	0.0	0.0	0.0	0.0	0.0	0.0	0.0	0.0
Detector 1 Delay (s)	0.0	0.0	0.0	0.0	0.0	0.0	0.0	0.0	0.0	0.0	0.0	0.0
Detector 2 Position(ft)								94			94	
Detector 2 Size(ft)								6			6	
Detector 2 Type								Cl+Ex			Cl+Ex	
Detector 2 Channel												
Detector 2 Extend (s)								0.0			0.0	
Turn Type	Split	NA	pm+ov	Split	NA	pm+ov	pm+pt	NA	Perm	pm+pt	NA	Perm
Protected Phases	4	4	5	8	8	1	5	2		1	6	
Permitted Phases			4			8	2		2	6		6

Lanes, Volumes, Timings
5: 103rd Avenue & Tower Road

10/03/2023



Lane Group	EBL	EBT	EBR	WBL	WBT	WBR	NBL	NBT	NBR	SBL	SBT	SBR
Detector Phase	4	4	5	8	8	1	5	2	2	1	6	6
Switch Phase												
Minimum Initial (s)	5.0	5.0	4.5	5.0	5.0	5.0	4.5	5.0	5.0	5.0	5.0	5.0
Minimum Split (s)	25.0	25.0	10.0	23.5	23.5	10.5	10.0	23.5	23.5	10.5	23.5	23.5
Total Split (s)	25.0	25.0	10.0	23.5	23.5	15.8	10.0	40.7	40.7	15.8	46.5	46.5
Total Split (%)	23.8%	23.8%	9.5%	22.4%	22.4%	15.0%	9.5%	38.8%	38.8%	15.0%	44.3%	44.3%
Maximum Green (s)	20.0	20.0	5.0	18.5	18.5	10.8	5.0	35.7	35.7	10.8	41.5	41.5
Yellow Time (s)	3.0	3.0	3.0	3.0	3.0	3.0	3.0	3.0	3.0	3.0	3.0	3.0
All-Red Time (s)	2.0	2.0	2.0	2.0	2.0	2.0	2.0	2.0	2.0	2.0	2.0	2.0
Lost Time Adjust (s)		0.0	0.0		0.0	0.0	0.0	0.0	0.0	0.0	0.0	0.0
Total Lost Time (s)		5.0	5.0		5.0	5.0	5.0	5.0	5.0	5.0	5.0	5.0
Lead/Lag			Lead			Lead	Lead	Lag	Lag	Lead	Lag	Lag
Lead-Lag Optimize?			Yes			Yes	Yes	Yes	Yes	Yes	Yes	Yes
Vehicle Extension (s)	3.0	3.0	3.0	3.0	3.0	3.0	3.0	3.0	3.0	3.0	3.0	3.0
Recall Mode	None	None	None	None	None	None	None	Min	Min	None	Min	Min
Walk Time (s)	7.0	7.0		7.0	7.0			7.0	7.0		7.0	7.0
Flash Dont Walk (s)	11.0	11.0		11.0	11.0			11.0	11.0		11.0	11.0
Pedestrian Calls (#/hr)	0	0		0	0			0	0		0	0
Act Effct Green (s)		6.2	6.3		9.5	20.1	44.2	39.1	39.1	50.6	42.3	42.3
Actuated g/C Ratio		0.09	0.09		0.13	0.28	0.62	0.55	0.55	0.71	0.59	0.59
v/c Ratio		0.09	0.26		0.43	0.38	0.55	0.53	0.09	0.53	0.75	0.03
Control Delay		35.2	2.8		36.4	4.9	21.9	13.7	0.2	14.4	15.2	0.0
Queue Delay		0.0	0.0		0.0	0.0	0.0	0.0	0.0	0.0	0.0	0.0
Total Delay		35.2	2.8		36.4	4.9	21.9	13.7	0.2	14.4	15.2	0.0
LOS		D	A		D	A	C	B	A	B	B	A
Approach Delay		8.5			14.4			13.6			15.0	
Approach LOS		A			B			B			B	

Intersection Summary

Area Type:	Other
Cycle Length:	105
Actuated Cycle Length:	71.4
Natural Cycle:	115
Control Type:	Actuated-Uncoordinated
Maximum v/c Ratio:	0.75
Intersection Signal Delay:	14.3
Intersection LOS:	B
Intersection Capacity Utilization:	70.9%
ICU Level of Service:	C
Analysis Period (min):	15

Splits and Phases: 5: 103rd Avenue & Tower Road

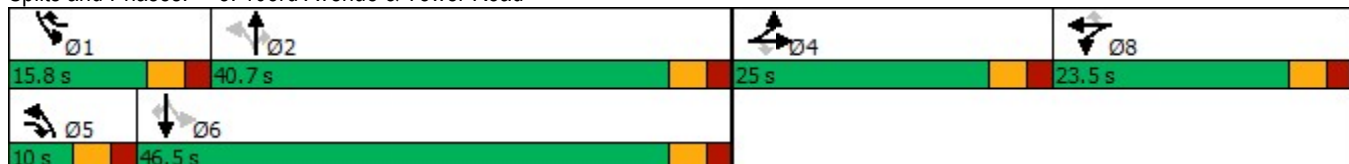

Queues

5: 103rd Avenue & Tower Road

10/03/2023





























Lane Group	EBT	EBR	WBT	WBR	NBL	NBT	NBR	SBL	SBT	SBR
Lane Group Flow (vph)	14	65	101	236	127	1481	87	174	2255	28
v/c Ratio	0.09	0.26	0.43	0.38	0.55	0.53	0.09	0.53	0.75	0.03
Control Delay	35.2	2.8	36.4	4.9	21.9	13.7	0.2	14.4	15.2	0.0
Queue Delay	0.0	0.0	0.0	0.0	0.0	0.0	0.0	0.0	0.0	0.0
Total Delay	35.2	2.8	36.4	4.9	21.9	13.7	0.2	14.4	15.2	0.0
Queue Length 50th (ft)	6	0	41	0	13	140	0	18	239	0
Queue Length 95th (ft)	22	0	84	43	#87	299	0	85	#546	0
Internal Link Dist (ft)	795		842			348			450	
Turn Bay Length (ft)		50		100	440		185	130		
Base Capacity (vph)	509	254	469	665	231	2781	945	391	3015	989
Starvation Cap Reductn	0	0	0	0	0	0	0	0	0	0
Spillback Cap Reductn	0	0	0	0	0	0	0	0	0	0
Storage Cap Reductn	0	0	0	0	0	0	0	0	0	0
Reduced v/c Ratio	0.03	0.26	0.22	0.35	0.55	0.53	0.09	0.45	0.75	0.03

Intersection Summary

95th percentile volume exceeds capacity, queue may be longer.
 Queue shown is maximum after two cycles.

HCM 6th Signalized Intersection Summary
5: 103rd Avenue & Tower Road

10/03/2023

												
Movement	EBL	EBT	EBR	WBL	WBT	WBR	NBL	NBT	NBR	SBL	SBT	SBR
Lane Configurations								  			  	
Traffic Volume (veh/h)	10	1	51	80	1	205	105	1377	69	146	2142	22
Future Volume (veh/h)	10	1	51	80	1	205	105	1377	69	146	2142	22
Initial Q (Qb), veh	0	0	0	0	0	0	0	0	0	0	0	0
Ped-Bike Adj(A_pbT)	1.00		1.00	1.00		1.00	1.00		1.00	1.00		1.00
Parking Bus, Adj	1.00	1.00	1.00	1.00	1.00	1.00	1.00	1.00	1.00	1.00	1.00	1.00
Work Zone On Approach		No			No			No			No	
Adj Sat Flow, veh/h/ln	1870	1870	1870	1870	1870	1870	1870	1870	1870	1870	1870	1870
Adj Flow Rate, veh/h	13	1	65	100	1	236	127	1481	87	174	2255	28
Peak Hour Factor	0.78	0.78	0.78	0.80	0.78	0.87	0.83	0.93	0.79	0.84	0.95	0.78
Percent Heavy Veh, %	2	2	2	2	2	2	2	2	2	2	2	2
Cap, veh/h	90	7	175	146	1	245	225	2664	827	341	2743	852
Arrive On Green	0.05	0.05	0.05	0.08	0.08	0.08	0.06	0.52	0.52	0.07	0.54	0.54
Sat Flow, veh/h	1660	128	1585	1764	18	1585	1781	5106	1585	1781	5106	1585
Grp Volume(v), veh/h	14	0	65	101	0	236	127	1481	87	174	2255	28
Grp Sat Flow(s),veh/h/ln	1787	0	1585	1782	0	1585	1781	1702	1585	1781	1702	1585
Q Serve(g_s), s	0.6	0.0	2.8	4.1	0.0	6.2	2.4	14.5	2.1	3.3	27.2	0.6
Cycle Q Clear(g_c), s	0.6	0.0	2.8	4.1	0.0	6.2	2.4	14.5	2.1	3.3	27.2	0.6
Prop In Lane	0.93		1.00	0.99		1.00	1.00		1.00	1.00		1.00
Lane Grp Cap(c), veh/h	97	0	175	148	0	245	225	2664	827	341	2743	852
V/C Ratio(X)	0.14	0.00	0.37	0.68	0.00	0.96	0.56	0.56	0.11	0.51	0.82	0.03
Avail Cap(c_a), veh/h	482	0	516	444	0	509	245	2664	827	473	2855	886
HCM Platoon Ratio	1.00	1.00	1.00	1.00	1.00	1.00	1.00	1.00	1.00	1.00	1.00	1.00
Upstream Filter(I)	1.00	0.00	1.00	1.00	0.00	1.00	1.00	1.00	1.00	1.00	1.00	1.00
Uniform Delay (d), s/veh	33.5	0.0	30.6	33.1	0.0	31.2	15.8	12.0	9.0	9.6	14.2	8.1
Incr Delay (d2), s/veh	0.7	0.0	1.3	5.5	0.0	19.1	2.5	0.3	0.1	1.2	2.0	0.0
Initial Q Delay(d3),s/veh	0.0	0.0	0.0	0.0	0.0	0.0	0.0	0.0	0.0	0.0	0.0	0.0
%ile BackOfQ(50%),veh/ln	0.3	0.0	1.1	1.9	0.0	5.3	1.0	4.3	0.6	1.2	9.5	0.2
Unsig. Movement Delay, s/veh												
LnGrp Delay(d),s/veh	34.1	0.0	31.9	38.6	0.0	50.3	18.3	12.2	9.0	10.7	16.2	8.1
LnGrp LOS	C	A	C	D	A	D	B	B	A	B	B	A
Approach Vol, veh/h		79			337			1695			2457	
Approach Delay, s/veh		32.3			46.8			12.5			15.7	
Approach LOS		C			D			B			B	
Timer - Assigned Phs	1	2		4	5	6		8				
Phs Duration (G+Y+Rc), s	10.3	43.7		9.0	9.2	44.9		11.2				
Change Period (Y+Rc), s	5.0	5.0		5.0	5.0	5.0		5.0				
Max Green Setting (Gmax), s	10.8	35.7		20.0	5.0	41.5		18.5				
Max Q Clear Time (g_c+I1), s	5.3	16.5		4.8	4.4	29.2		6.1				
Green Ext Time (p_c), s	0.2	9.9		0.2	0.0	10.7		0.1				
Intersection Summary												
HCM 6th Ctrl Delay			17.1									
HCM 6th LOS			B									

Lanes, Volumes, Timings
1: Walden Street & 104th Avenue

10/03/2023

Lane Group	EBL	EBT	EBR	WBL	WBT	WBR	NBL	NBT	NBR	SBL	SBT	SBR
Lane Configurations												
Traffic Volume (vph)	93	1023	156	25	1380	162	232	50	45	227	17	76
Future Volume (vph)	93	1023	156	25	1380	162	232	50	45	227	17	76
Ideal Flow (vphpl)	1900	1900	1900	1900	1900	1900	1900	1900	1900	1900	1900	1900
Storage Length (ft)	400		230	0		250	230		230	210		140
Storage Lanes	1		1	1		1	1		1	1		1
Taper Length (ft)	25			25			25			25		
Lane Util. Factor	1.00	0.95	1.00	1.00	0.95	1.00	1.00	1.00	1.00	1.00	1.00	1.00
Frt			0.850			0.850			0.850			0.850
Flt Protected	0.950			0.950			0.950			0.950		
Satd. Flow (prot)	1770	3539	1583	1770	3539	1583	1770	1863	1583	1770	1863	1583
Flt Permitted	0.065			0.189			0.743			0.498		
Satd. Flow (perm)	121	3539	1583	352	3539	1583	1384	1863	1583	928	1863	1583
Right Turn on Red			Yes			Yes			Yes			Yes
Satd. Flow (RTOR)			186			159			168			168
Link Speed (mph)		45			45			30				30
Link Distance (ft)		149			767			699				204
Travel Time (s)		2.3			11.6			15.9				4.6
Peak Hour Factor	0.80	0.93	0.84	0.78	0.93	0.84	0.88	0.78	0.78	0.87	0.78	0.80
Adj. Flow (vph)	116	1100	186	32	1484	193	264	64	58	261	22	95
Shared Lane Traffic (%)												
Lane Group Flow (vph)	116	1100	186	32	1484	193	264	64	58	261	22	95
Enter Blocked Intersection	No	No	No	No	No	No	No	No	No	No	No	No
Lane Alignment	Left	Left	Right	Left	Left	Right	Left	Left	Right	Left	Left	Right
Median Width(ft)		12			12			12				12
Link Offset(ft)		0			0			0				0
Crosswalk Width(ft)		16			16			16				16
Two way Left Turn Lane												
Headway Factor	1.00	1.00	1.00	1.00	1.00	1.00	1.00	1.00	1.00	1.00	1.00	1.00
Turning Speed (mph)	15		9	15		9	15		9	15		9
Number of Detectors	1	2	1	1	2	1	1	2	1	1	2	1
Detector Template	Left	Thru	Right	Left	Thru	Right	Left	Thru	Right	Left	Thru	Right
Leading Detector (ft)	20	100	20	20	100	20	20	100	20	20	100	20
Trailing Detector (ft)	0	0	0	0	0	0	0	0	0	0	0	0
Detector 1 Position(ft)	0	0	0	0	0	0	0	0	0	0	0	0
Detector 1 Size(ft)	20	6	20	20	6	20	20	6	20	20	6	20
Detector 1 Type	Cl+Ex	Cl+Ex	Cl+Ex	Cl+Ex	Cl+Ex	Cl+Ex	Cl+Ex	Cl+Ex	Cl+Ex	Cl+Ex	Cl+Ex	Cl+Ex
Detector 1 Channel												
Detector 1 Extend (s)	0.0	0.0	0.0	0.0	0.0	0.0	0.0	0.0	0.0	0.0	0.0	0.0
Detector 1 Queue (s)	0.0	0.0	0.0	0.0	0.0	0.0	0.0	0.0	0.0	0.0	0.0	0.0
Detector 1 Delay (s)	0.0	0.0	0.0	0.0	0.0	0.0	0.0	0.0	0.0	0.0	0.0	0.0
Detector 2 Position(ft)		94			94			94				94
Detector 2 Size(ft)		6			6			6				6
Detector 2 Type		Cl+Ex			Cl+Ex			Cl+Ex				Cl+Ex
Detector 2 Channel												
Detector 2 Extend (s)		0.0			0.0			0.0				0.0
Turn Type	pm+pt	NA	Perm	pm+pt	NA	Perm	pm+pt	NA	Perm	pm+pt	NA	Perm
Protected Phases	5	2		1	6		3	8		7	4	
Permitted Phases	2		2	6		6	8		8	4		4

Lanes, Volumes, Timings
1: Walden Street & 104th Avenue

10/03/2023

Lane Group	EBL	EBT	EBR	WBL	WBT	WBR	NBL	NBT	NBR	SBL	SBT	SBR
Detector Phase	5	2	2	1	6	6	3	8	8	7	4	4
Switch Phase												
Minimum Initial (s)	5.0	10.0	10.0	5.0	10.0	10.0	8.0	10.0	10.0	8.0	10.0	10.0
Minimum Split (s)	12.5	17.5	17.5	12.5	17.5	17.5	14.5	16.5	16.5	14.5	16.5	16.5
Total Split (s)	15.6	68.6	68.6	12.6	65.6	65.6	22.0	16.6	16.6	22.2	16.8	16.8
Total Split (%)	13.0%	57.2%	57.2%	10.5%	54.7%	54.7%	18.3%	13.8%	13.8%	18.5%	14.0%	14.0%
Maximum Green (s)	8.1	61.1	61.1	5.1	58.1	58.1	15.5	10.1	10.1	15.7	10.3	10.3
Yellow Time (s)	5.3	5.3	5.3	5.3	5.3	5.3	3.8	3.8	3.8	3.8	3.8	3.8
All-Red Time (s)	2.2	2.2	2.2	2.2	2.2	2.2	2.7	2.7	2.7	2.7	2.7	2.7
Lost Time Adjust (s)	0.0	0.0	0.0	0.0	0.0	0.0	0.0	0.0	0.0	0.0	0.0	0.0
Total Lost Time (s)	7.5	7.5	7.5	7.5	7.5	7.5	6.5	6.5	6.5	6.5	6.5	6.5
Lead/Lag	Lead	Lag	Lag	Lead	Lag	Lag	Lead	Lag	Lag	Lead	Lag	Lag
Lead-Lag Optimize?	Yes	Yes	Yes	Yes	Yes	Yes	Yes	Yes	Yes	Yes	Yes	Yes
Vehicle Extension (s)	2.0	5.0	5.0	2.0	5.0	5.0	2.0	2.0	2.0	2.0	2.0	2.0
Recall Mode	None	C-Max	C-Max	None	C-Max	C-Max	None	None	None	None	None	None
Act Effct Green (s)	71.2	66.3	66.3	64.0	58.9	58.9	23.5	10.0	10.0	27.1	10.2	10.2
Actuated g/C Ratio	0.59	0.55	0.55	0.53	0.49	0.49	0.20	0.08	0.08	0.23	0.08	0.08
v/c Ratio	0.67	0.56	0.19	0.13	0.85	0.22	0.82	0.41	0.20	0.76	0.14	0.33
Control Delay	38.3	19.8	2.7	6.8	21.2	1.2	62.4	60.7	1.6	54.6	53.1	3.1
Queue Delay	0.0	0.0	0.0	0.0	0.0	0.0	0.0	0.0	0.0	0.0	0.0	0.0
Total Delay	38.3	19.8	2.7	6.8	21.2	1.2	62.4	60.7	1.6	54.6	53.1	3.1
LOS	D	B	A	A	C	A	E	E	A	D	D	A
Approach Delay		19.1			18.7			53.0			41.6	
Approach LOS		B			B			D			D	

Intersection Summary

Area Type:	Other
Cycle Length:	120
Actuated Cycle Length:	120
Offset:	0 (0%), Referenced to phase 2:EBTL and 6:WBTL, Start of Yellow
Natural Cycle:	90
Control Type:	Actuated-Coordinated
Maximum v/c Ratio:	0.85
Intersection Signal Delay:	24.5
Intersection LOS:	C
Intersection Capacity Utilization:	80.7%
ICU Level of Service:	D
Analysis Period (min):	15

Splits and Phases: 1: Walden Street & 104th Avenue

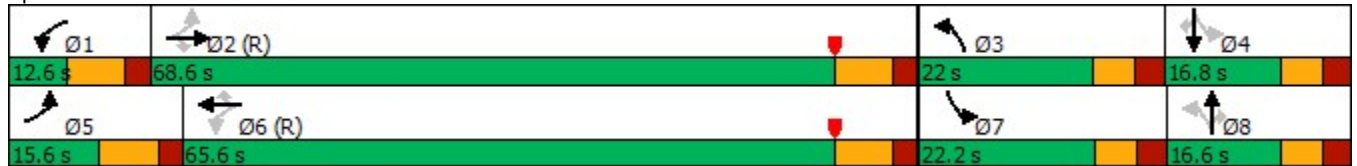

Queues

1: Walden Street & 104th Avenue

10/03/2023



Lane Group	EBL	EBT	EBR	WBL	WBT	WBR	NBL	NBT	NBR	SBL	SBT	SBR
Lane Group Flow (vph)	116	1100	186	32	1484	193	264	64	58	261	22	95
v/c Ratio	0.67	0.56	0.19	0.13	0.85	0.22	0.82	0.41	0.20	0.76	0.14	0.33
Control Delay	38.3	19.8	2.7	6.8	21.2	1.2	62.4	60.7	1.6	54.6	53.1	3.1
Queue Delay	0.0	0.0	0.0	0.0	0.0	0.0	0.0	0.0	0.0	0.0	0.0	0.0
Total Delay	38.3	19.8	2.7	6.8	21.2	1.2	62.4	60.7	1.6	54.6	53.1	3.1
Queue Length 50th (ft)	36	308	0	5	443	6	176	48	0	174	16	0
Queue Length 95th (ft)	82	377	29	m8	430	m7	#273	81	0	#254	37	0
Internal Link Dist (ft)		69			687			619			124	
Turn Bay Length (ft)	400		230			250	230		230	210		140
Base Capacity (vph)	183	1954	957	248	1738	858	320	156	287	342	159	289
Starvation Cap Reductn	0	0	0	0	0	0	0	0	0	0	0	0
Spillback Cap Reductn	0	0	0	0	0	0	0	0	0	0	0	0
Storage Cap Reductn	0	0	0	0	0	0	0	0	0	0	0	0
Reduced v/c Ratio	0.63	0.56	0.19	0.13	0.85	0.22	0.82	0.41	0.20	0.76	0.14	0.33

























Intersection Summary

- # 95th percentile volume exceeds capacity, queue may be longer.
Queue shown is maximum after two cycles.
- m Volume for 95th percentile queue is metered by upstream signal.

HCM 6th Signalized Intersection Summary

1: Walden Street & 104th Avenue

10/03/2023

												
Movement	EBL	EBT	EBR	WBL	WBT	WBR	NBL	NBT	NBR	SBL	SBT	SBR
Lane Configurations												
Traffic Volume (veh/h)	93	1023	156	25	1380	162	232	50	45	227	17	76
Future Volume (veh/h)	93	1023	156	25	1380	162	232	50	45	227	17	76
Initial Q (Qb), veh	0	0	0	0	0	0	0	0	0	0	0	0
Ped-Bike Adj(A_pbT)	1.00		1.00	1.00		1.00	1.00		1.00	1.00		1.00
Parking Bus, Adj	1.00	1.00	1.00	1.00	1.00	1.00	1.00	1.00	1.00	1.00	1.00	1.00
Work Zone On Approach		No			No			No			No	
Adj Sat Flow, veh/h/ln	1870	1870	1870	1870	1870	1870	1870	1870	1870	1870	1870	1870
Adj Flow Rate, veh/h	116	1100	186	32	1484	193	264	64	58	261	22	95
Peak Hour Factor	0.80	0.93	0.84	0.78	0.93	0.84	0.88	0.78	0.78	0.87	0.78	0.80
Percent Heavy Veh, %	2	2	2	2	2	2	2	2	2	2	2	2
Cap, veh/h	323	1866	832	269	1796	801	393	156	132	361	159	135
Arrive On Green	0.05	0.53	0.53	0.05	1.00	1.00	0.13	0.08	0.08	0.13	0.09	0.09
Sat Flow, veh/h	1781	3554	1585	1781	3554	1585	1781	1870	1585	1781	1870	1585
Grp Volume(v), veh/h	116	1100	186	32	1484	193	264	64	58	261	22	95
Grp Sat Flow(s),veh/h/ln	1781	1777	1585	1781	1777	1585	1781	1870	1585	1781	1870	1585
Q Serve(g_s), s	3.7	25.5	7.6	1.0	0.0	0.0	15.5	3.9	4.2	15.7	1.3	7.0
Cycle Q Clear(g_c), s	3.7	25.5	7.6	1.0	0.0	0.0	15.5	3.9	4.2	15.7	1.3	7.0
Prop In Lane	1.00		1.00	1.00		1.00	1.00		1.00	1.00		1.00
Lane Grp Cap(c), veh/h	323	1866	832	269	1796	801	393	156	132	361	159	135
V/C Ratio(X)	0.36	0.59	0.22	0.12	0.83	0.24	0.67	0.41	0.44	0.72	0.14	0.71
Avail Cap(c_a), veh/h	360	1866	832	296	1796	801	393	157	133	361	161	136
HCM Platoon Ratio	1.00	1.00	1.00	2.00	2.00	2.00	1.00	1.00	1.00	1.00	1.00	1.00
Upstream Filter(I)	1.00	1.00	1.00	1.00	1.00	1.00	1.00	1.00	1.00	1.00	1.00	1.00
Uniform Delay (d), s/veh	12.9	19.6	15.3	15.3	0.0	0.0	43.8	52.2	52.3	43.6	50.8	53.4
Incr Delay (d2), s/veh	0.2	1.4	0.6	0.1	4.5	0.7	3.6	0.6	0.9	6.1	0.1	13.0
Initial Q Delay(d3),s/veh	0.0	0.0	0.0	0.0	0.0	0.0	0.0	0.0	0.0	0.0	0.0	0.0
%ile BackOfQ(50%),veh/ln	1.4	10.1	2.9	0.4	1.1	0.2	7.6	1.9	1.7	7.7	0.6	3.3
Unsig. Movement Delay, s/veh												
LnGrp Delay(d),s/veh	13.1	21.0	15.9	15.3	4.5	0.7	47.4	52.8	53.2	49.7	51.0	66.4
LnGrp LOS	B	C	B	B	A	A	D	D	D	D	D	E
Approach Vol, veh/h		1402			1709			386			378	
Approach Delay, s/veh		19.6			4.3			49.2			54.0	
Approach LOS		B			A			D			D	
Timer - Assigned Phs	1	2	3	4	5	6	7	8				
Phs Duration (G+Y+Rc), s	10.8	70.5	22.0	16.7	13.1	68.2	22.2	16.5				
Change Period (Y+Rc), s	* 7.5	* 7.5	6.5	6.5	* 7.5	* 7.5	6.5	6.5				
Max Green Setting (Gmax), s	* 5.1	* 61	15.5	10.3	* 8.1	* 58	15.7	10.1				
Max Q Clear Time (g_c+I1), s	3.0	27.5	17.5	9.0	5.7	2.0	17.7	6.2				
Green Ext Time (p_c), s	0.0	18.4	0.0	0.0	0.0	35.3	0.0	0.1				
Intersection Summary												
HCM 6th Ctrl Delay				19.2								
HCM 6th LOS				B								
Notes												
* HCM 6th computational engine requires equal clearance times for the phases crossing the barrier.												

Lanes, Volumes, Timings
2: Yampa Street & 104th Avenue

10/03/2023

	→	↘	↙	←	↖	↗
Lane Group	EBT	EBR	WBL	WBT	NBL	NBR
Lane Configurations	↑↑↑	↗	↘	↑↑↑		↗
Traffic Volume (vph)	1172	41	34	903	0	28
Future Volume (vph)	1172	41	34	903	0	28
Ideal Flow (vphpl)	1900	1900	1900	1900	1900	1900
Storage Length (ft)		50	50		0	0
Storage Lanes		1	1		0	1
Taper Length (ft)			25		25	
Lane Util. Factor	0.91	1.00	1.00	0.91	1.00	1.00
Frt		0.850				0.865
Flt Protected			0.950			
Satd. Flow (prot)	5085	1583	1770	5085	0	1611
Flt Permitted			0.950			
Satd. Flow (perm)	5085	1583	1770	5085	0	1611
Link Speed (mph)	35			45	30	
Link Distance (ft)	767			1110	440	
Travel Time (s)	14.9			16.8	10.0	
Peak Hour Factor	0.93	0.78	0.78	0.92	0.78	0.78
Adj. Flow (vph)	1260	53	44	982	0	36
Shared Lane Traffic (%)						
Lane Group Flow (vph)	1260	53	44	982	0	36
Enter Blocked Intersection	No	No	No	No	No	No
Lane Alignment	Left	Right	Left	Left	Left	Right
Median Width(ft)	24			24	0	
Link Offset(ft)	0			0	0	
Crosswalk Width(ft)	16			16	16	
Two way Left Turn Lane						
Headway Factor	1.00	1.00	1.00	1.00	1.00	1.00
Turning Speed (mph)		9	15		15	9
Sign Control	Free			Free	Stop	
Intersection Summary						
Area Type:	Other					
Control Type:	Unsignalized					
Intersection Capacity Utilization	32.6%			ICU Level of Service A		
Analysis Period (min)	15					

Intersection						
Int Delay, s/veh	0.6					
Movement	EBT	EBR	WBL	WBT	NBL	NBR
Lane Configurations	↑↑↑↑	↑	↑	↑↑↑↑		↑
Traffic Vol, veh/h	1172	41	34	903	0	28
Future Vol, veh/h	1172	41	34	903	0	28
Conflicting Peds, #/hr	0	0	0	0	0	0
Sign Control	Free	Free	Free	Free	Stop	Stop
RT Channelized	-	None	-	None	-	None
Storage Length	-	50	50	-	-	0
Veh in Median Storage, #	0	-	-	0	0	-
Grade, %	0	-	-	0	0	-
Peak Hour Factor	93	78	78	92	78	78
Heavy Vehicles, %	2	2	2	2	2	2
Mvmt Flow	1260	53	44	982	0	36

Major/Minor	Major1	Major2	Minor1		
Conflicting Flow All	0	0	1313	0	630
Stage 1	-	-	-	-	-
Stage 2	-	-	-	-	-
Critical Hdwy	-	-	5.34	-	7.14
Critical Hdwy Stg 1	-	-	-	-	-
Critical Hdwy Stg 2	-	-	-	-	-
Follow-up Hdwy	-	-	3.12	-	3.92
Pot Cap-1 Maneuver	-	-	276	0	364
Stage 1	-	-	-	0	-
Stage 2	-	-	-	0	-
Platoon blocked, %	-	-	-	-	-
Mov Cap-1 Maneuver	-	-	276	-	364
Mov Cap-2 Maneuver	-	-	-	-	-
Stage 1	-	-	-	-	-
Stage 2	-	-	-	-	-

Approach	EB	WB	NB
HCM Control Delay, s	0	0.9	16
HCM LOS			C

Minor Lane/Major Mvmt	NBLn1	EBT	EBR	WBL	WBT
Capacity (veh/h)	364	-	-	276	-
HCM Lane V/C Ratio	0.099	-	-	0.158	-
HCM Control Delay (s)	16	-	-	20.5	-
HCM Lane LOS	C	-	-	C	-
HCM 95th %tile Q(veh)	0.3	-	-	0.6	-

Lanes, Volumes, Timings
3: Tower Road & 104th Avenue

10/03/2023

Lane Group	EBL	EBT	EBR	WBL	WBT	WBR	NBL	NBT	NBR	SBL	SBT	SBR
Lane Configurations												
Traffic Volume (vph)	163	274	588	40	360	25	887	1498	43	14	882	126
Future Volume (vph)	163	274	588	40	360	25	887	1498	43	14	882	126
Ideal Flow (vphpl)	1900	1900	1900	1900	1900	1900	1900	1900	1900	1900	1900	1900
Storage Length (ft)	350		590	330		440	320		290	290		190
Storage Lanes	2		1	2		1	2		1	2		1
Taper Length (ft)	25			25			25			25		
Lane Util. Factor	0.97	0.91	1.00	0.97	0.91	1.00	0.97	0.91	1.00	0.97	0.91	1.00
Frt			0.850			0.850			0.850			0.850
Flt Protected	0.950			0.950			0.950			0.950		
Satd. Flow (prot)	3433	5085	1583	3433	5085	1583	3433	5085	1583	3433	5085	1583
Flt Permitted	0.950			0.950			0.950			0.950		
Satd. Flow (perm)	3433	5085	1583	3433	5085	1583	3433	5085	1583	3433	5085	1583
Right Turn on Red			Yes			Yes			Yes			Yes
Satd. Flow (RTOR)			639			264			182			256
Link Speed (mph)		45			45			50			50	
Link Distance (ft)		1110			840			620			1000	
Travel Time (s)		16.8			12.7			8.5			13.6	
Peak Hour Factor	0.84	0.88	0.92	0.78	0.88	0.78	0.92	0.93	0.78	0.78	0.92	0.84
Adj. Flow (vph)	194	311	639	51	409	32	964	1611	55	18	959	150
Shared Lane Traffic (%)												
Lane Group Flow (vph)	194	311	639	51	409	32	964	1611	55	18	959	150
Enter Blocked Intersection	No	No	No	No	No	No	No	No	No	No	No	No
Lane Alignment	Left	Left	Right	Left	Left	Right	Left	Left	Right	Left	Left	Right
Median Width(ft)		24			24			24			24	
Link Offset(ft)		0			0			0			0	
Crosswalk Width(ft)		16			16			16			16	
Two way Left Turn Lane												
Headway Factor	1.00	1.00	1.00	1.00	1.00	1.00	1.00	1.00	1.00	1.00	1.00	1.00
Turning Speed (mph)	15		9	15		9	15		9	15		9
Number of Detectors	1	1	1	1	1	1	1	1	1	1	1	1
Detector Template	Left	Thru	Right	Left	Thru	Right	Left	Thru	Right	Left	Thru	Right
Leading Detector (ft)	40	40	40	40	40	40	40	40	40	40	40	40
Trailing Detector (ft)	0	0	0	0	0	0	0	0	0	0	0	0
Detector 1 Position(ft)	0	0	0	0	0	0	0	0	0	0	0	0
Detector 1 Size(ft)	40	40	40	40	40	40	40	40	40	40	40	40
Detector 1 Type	Cl+Ex	Cl+Ex	Cl+Ex	Cl+Ex	Cl+Ex	Cl+Ex	Cl+Ex	Cl+Ex	Cl+Ex	Cl+Ex	Cl+Ex	Cl+Ex
Detector 1 Channel												
Detector 1 Extend (s)	0.0	0.0	0.0	0.0	0.0	0.0	0.0	0.0	0.0	0.0	0.0	0.0
Detector 1 Queue (s)	0.0	0.0	0.0	0.0	0.0	0.0	0.0	0.0	0.0	0.0	0.0	0.0
Detector 1 Delay (s)	0.0	0.0	0.0	0.0	0.0	0.0	0.0	0.0	0.0	0.0	0.0	0.0
Turn Type	Prot	NA	Perm	Prot	NA	Perm	Prot	NA	Perm	Prot	NA	Perm
Protected Phases	7	4		3	8		5	2		1	6	
Permitted Phases			4			8			2			6
Detector Phase	7	4	4	3	8	8	5	2	2	1	6	6
Switch Phase												
Minimum Initial (s)	3.6	3.6	3.6	3.6	10.0	10.0	8.0	10.0	10.0	5.8	10.0	10.0
Minimum Split (s)	11.0	11.0	11.0	11.0	31.0	31.0	16.2	38.0	38.0	14.0	25.0	25.0
Total Split (s)	17.0	37.0	37.0	11.0	31.0	31.0	46.0	58.0	58.0	14.0	26.0	26.0

Lanes, Volumes, Timings
3: Tower Road & 104th Avenue

10/03/2023



Lane Group	EBL	EBT	EBR	WBL	WBT	WBR	NBL	NBT	NBR	SBL	SBT	SBR
Total Split (%)	14.2%	30.8%	30.8%	9.2%	25.8%	25.8%	38.3%	48.3%	48.3%	11.7%	21.7%	21.7%
Maximum Green (s)	9.6	29.6	29.6	3.6	23.6	23.6	37.8	49.8	49.8	5.8	17.8	17.8
Yellow Time (s)	5.0	5.0	5.0	5.0	5.0	5.0	5.1	5.1	5.1	5.1	5.1	5.1
All-Red Time (s)	2.4	2.4	2.4	2.4	2.4	2.4	3.1	3.1	3.1	3.1	3.1	3.1
Lost Time Adjust (s)	0.0	0.0	0.0	0.0	0.0	0.0	0.0	0.0	0.0	0.0	0.0	0.0
Total Lost Time (s)	7.4	7.4	7.4	7.4	7.4	7.4	8.2	8.2	8.2	8.2	8.2	8.2
Lead/Lag	Lead	Lag	Lag	Lead	Lag	Lag	Lead	Lag	Lag	Lead	Lag	Lag
Lead-Lag Optimize?	Yes	Yes	Yes	Yes	Yes	Yes	Yes	Yes	Yes	Yes	Yes	Yes
Vehicle Extension (s)	2.0	2.0	2.0	2.0	2.0	2.0	2.0	5.0	5.0	2.0	5.0	5.0
Recall Mode	None	None	None	None	None	None	None	C-Min	C-Min	None	C-Min	C-Min
Act Effct Green (s)	9.3	22.7	22.7	3.6	14.9	14.9	37.4	67.2	67.2	5.9	27.3	27.3
Actuated g/C Ratio	0.08	0.19	0.19	0.03	0.12	0.12	0.31	0.56	0.56	0.05	0.23	0.23
v/c Ratio	0.73	0.32	0.78	0.50	0.65	0.07	0.90	0.57	0.06	0.11	0.83	0.27
Control Delay	58.9	41.3	21.3	74.1	54.6	0.4	51.7	19.8	0.1	56.1	52.3	1.2
Queue Delay	0.0	0.0	0.0	0.0	0.0	0.0	0.0	0.0	0.0	0.0	0.0	0.0
Total Delay	58.9	41.3	21.3	74.1	54.6	0.4	51.7	19.8	0.1	56.1	52.3	1.2
LOS	E	D	C	E	D	A	D	B	A	E	D	A
Approach Delay		33.1			53.1			31.1			45.5	
Approach LOS		C			D			C			D	

Intersection Summary

Area Type: Other
 Cycle Length: 120
 Actuated Cycle Length: 120
 Offset: 0 (0%), Referenced to phase 2:NBT and 6:SBT, Start of Yellow, Master Intersection
 Natural Cycle: 115
 Control Type: Actuated-Coordinated
 Maximum v/c Ratio: 0.90
 Intersection Signal Delay: 36.6
 Intersection LOS: D
 Intersection Capacity Utilization 81.3%
 ICU Level of Service D
 Analysis Period (min) 15

Splits and Phases: 3: Tower Road & 104th Avenue

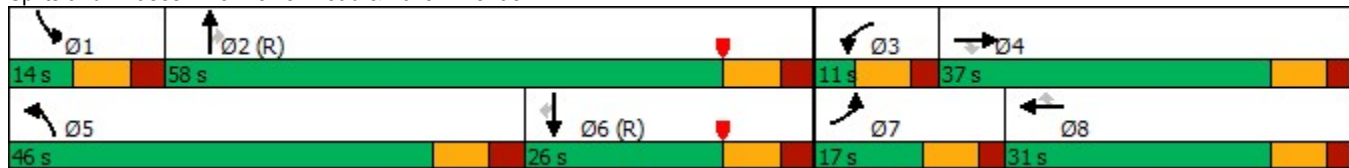

Queues

3: Tower Road & 104th Avenue

10/03/2023



Lane Group	EBL	EBT	EBR	WBL	WBT	WBR	NBL	NBT	NBR	SBL	SBT	SBR
Lane Group Flow (vph)	194	311	639	51	409	32	964	1611	55	18	959	150
v/c Ratio	0.73	0.32	0.78	0.50	0.65	0.07	0.90	0.57	0.06	0.11	0.83	0.27
Control Delay	58.9	41.3	21.3	74.1	54.6	0.4	51.7	19.8	0.1	56.1	52.3	1.2
Queue Delay	0.0	0.0	0.0	0.0	0.0	0.0	0.0	0.0	0.0	0.0	0.0	0.0
Total Delay	58.9	41.3	21.3	74.1	54.6	0.4	51.7	19.8	0.1	56.1	52.3	1.2
Queue Length 50th (ft)	77	86	231	20	113	0	362	243	0	7	262	0
Queue Length 95th (ft)	m108	m108	316	36	136	0	441	434	0	17	#435	0
Internal Link Dist (ft)		1030			760			540			920	
Turn Bay Length (ft)	350		590	330		440	320		290	290		190
Base Capacity (vph)	274	1254	871	102	1000	523	1116	2847	966	167	1156	557
Starvation Cap Reductn	0	0	0	0	0	0	0	0	0	0	0	0
Spillback Cap Reductn	0	0	0	0	0	0	0	0	0	0	0	0
Storage Cap Reductn	0	0	0	0	0	0	0	0	0	0	0	0
Reduced v/c Ratio	0.71	0.25	0.73	0.50	0.41	0.06	0.86	0.57	0.06	0.11	0.83	0.27

Intersection Summary

- # 95th percentile volume exceeds capacity, queue may be longer.
Queue shown is maximum after two cycles.
- m Volume for 95th percentile queue is metered by upstream signal.

HCM 6th Signalized Intersection Summary
 3: Tower Road & 104th Avenue

10/03/2023



Movement	EBL	EBT	EBR	WBL	WBT	WBR	NBL	NBT	NBR	SBL	SBT	SBR
Lane Configurations	↖↗	↑↑↑	↖	↖↗	↑↑↑	↖	↖↗	↑↑↑	↖	↖↗	↑↑↑	↖
Traffic Volume (veh/h)	163	274	588	40	360	25	887	1498	43	14	882	126
Future Volume (veh/h)	163	274	588	40	360	25	887	1498	43	14	882	126
Initial Q (Qb), veh	0	0	0	0	0	0	0	0	0	0	0	0
Ped-Bike Adj(A_pbT)	1.00		1.00	1.00		1.00	1.00		1.00	1.00		1.00
Parking Bus, Adj	1.00	1.00	1.00	1.00	1.00	1.00	1.00	1.00	1.00	1.00	1.00	1.00
Work Zone On Approach		No			No			No			No	
Adj Sat Flow, veh/h/ln	1870	1870	1870	1870	1870	1870	1870	1870	1870	1870	1870	1870
Adj Flow Rate, veh/h	194	311	0	51	409	0	964	1611	0	18	959	0
Peak Hour Factor	0.84	0.88	0.92	0.78	0.88	0.78	0.92	0.93	0.78	0.78	0.92	0.84
Percent Heavy Veh, %	2	2	2	2	2	2	2	2	2	2	2	2
Cap, veh/h	251	759		88	518		1026	2778		75	1374	
Arrive On Green	0.02	0.05	0.00	0.03	0.10	0.00	0.30	0.54	0.00	0.02	0.27	0.00
Sat Flow, veh/h	3456	5106	1585	3456	5106	1585	3456	5106	1585	3456	5106	1585
Grp Volume(v), veh/h	194	311	0	51	409	0	964	1611	0	18	959	0
Grp Sat Flow(s),veh/h/ln	1728	1702	1585	1728	1702	1585	1728	1702	1585	1728	1702	1585
Q Serve(g_s), s	6.7	7.1	0.0	1.8	9.4	0.0	32.6	25.2	0.0	0.6	20.3	0.0
Cycle Q Clear(g_c), s	6.7	7.1	0.0	1.8	9.4	0.0	32.6	25.2	0.0	0.6	20.3	0.0
Prop In Lane	1.00		1.00	1.00		1.00	1.00		1.00	1.00		1.00
Lane Grp Cap(c), veh/h	251	759		88	518		1026	2778		75	1374	
V/C Ratio(X)	0.77	0.41		0.58	0.79		0.94	0.58		0.24	0.70	
Avail Cap(c_a), veh/h	276	1260		104	1004		1089	2778		167	1374	
HCM Platoon Ratio	0.33	0.33	0.33	1.00	1.00	1.00	1.00	1.00	1.00	1.00	1.00	1.00
Upstream Filter(I)	1.00	1.00	0.00	1.00	1.00	0.00	1.00	1.00	0.00	1.00	1.00	0.00
Uniform Delay (d), s/veh	57.6	52.0	0.0	57.8	52.7	0.0	41.1	18.2	0.0	57.7	39.5	0.0
Incr Delay (d2), s/veh	10.0	0.1	0.0	2.2	1.0	0.0	14.2	0.9	0.0	0.6	3.0	0.0
Initial Q Delay(d3),s/veh	0.0	0.0	0.0	0.0	0.0	0.0	0.0	0.0	0.0	0.0	0.0	0.0
%ile BackOfQ(50%),veh/ln	3.3	3.1	0.0	0.8	4.0	0.0	15.1	9.2	0.0	0.3	8.5	0.0
Unsig. Movement Delay, s/veh												
LnGrp Delay(d),s/veh	67.6	52.1	0.0	60.0	53.7	0.0	55.3	19.1	0.0	58.3	42.4	0.0
LnGrp LOS	E	D		E	D		E	B		E	D	
Approach Vol, veh/h		505			460			2575			977	
Approach Delay, s/veh		58.0			54.4			32.7			42.7	
Approach LOS		E			D			C			D	
Timer - Assigned Phs	1	2	3	4	5	6	7	8				
Phs Duration (G+Y+Rc), s	10.8	73.5	10.5	25.2	43.8	40.5	16.1	19.6				
Change Period (Y+Rc), s	8.2	8.2	7.4	7.4	8.2	8.2	7.4	7.4				
Max Green Setting (Gmax), s	5.8	49.8	3.6	29.6	37.8	17.8	9.6	23.6				
Max Q Clear Time (g_c+I1), s	2.6	27.2	3.8	9.1	34.6	22.3	8.7	11.4				
Green Ext Time (p_c), s	0.0	15.1	0.0	0.7	1.0	0.0	0.0	0.8				

Intersection Summary

HCM 6th Ctrl Delay	39.9
HCM 6th LOS	D

Notes

User approved pedestrian interval to be less than phase max green.
 Unsignalized Delay for [NBR, EBR, WBR, SBR] is excluded from calculations of the approach delay and intersection delay.

Lanes, Volumes, Timings
4: Tower Road & Private Access

10/03/2023



Lane Group	EBL	EBR	NBL	NBT	SBT	SBR
Lane Configurations						
Traffic Volume (vph)	0	11	0	0	0	14
Future Volume (vph)	0	11	0	0	0	14
Ideal Flow (vphpl)	1900	1900	1900	1900	1900	1900
Lane Util. Factor	1.00	1.00	1.00	0.95	0.91	0.91
Fr _t		0.865			0.850	
Fl _t Protected						
Satd. Flow (prot)	0	1611	0	3539	4322	0
Fl _t Permitted						
Satd. Flow (perm)	0	1611	0	3539	4322	0
Link Speed (mph)	30			50	30	
Link Distance (ft)	345			530	620	
Travel Time (s)	7.8			7.2	14.1	
Peak Hour Factor	0.78	0.78	0.78	0.78	0.78	0.78
Adj. Flow (vph)	0	14	0	0	0	18
Shared Lane Traffic (%)						
Lane Group Flow (vph)	0	14	0	0	18	0
Enter Blocked Intersection	No	No	No	No	No	No
Lane Alignment	Left	Right	Left	Left	Left	Right
Median Width(ft)	0			24	24	
Link Offset(ft)	0			0	0	
Crosswalk Width(ft)	16			16	16	
Two way Left Turn Lane						
Headway Factor	1.00	1.00	1.00	1.00	1.00	1.00
Turning Speed (mph)	15	9	15			9
Sign Control	Stop			Free	Free	

Intersection Summary

Area Type:	Other
Control Type:	Unsignalized
Intersection Capacity Utilization	13.3%
ICU Level of Service	A
Analysis Period (min)	15

Intersection						
Int Delay, s/veh	4					
Movement	EBL	EBR	NBL	NBT	SBT	SBR
Lane Configurations		↗		↑↑	↑↑↑	
Traffic Vol, veh/h	0	11	0	0	0	14
Future Vol, veh/h	0	11	0	0	0	14
Conflicting Peds, #/hr	0	0	0	0	0	0
Sign Control	Stop	Stop	Free	Free	Free	Free
RT Channelized	-	None	-	None	-	None
Storage Length	-	0	-	-	-	-
Veh in Median Storage, #	0	-	-	0	0	-
Grade, %	0	-	-	0	0	-
Peak Hour Factor	78	78	78	78	78	78
Heavy Vehicles, %	2	2	2	2	2	2
Mvmt Flow	0	14	0	0	0	18























Major/Minor	Minor2	Major1	Major2
Conflicting Flow All	-	9	0
Stage 1	-	-	-
Stage 2	-	-	-
Critical Hdwy	-	7.14	-
Critical Hdwy Stg 1	-	-	-
Critical Hdwy Stg 2	-	-	-
Follow-up Hdwy	-	3.92	-
Pot Cap-1 Maneuver	0	907	0
Stage 1	0	-	0
Stage 2	0	-	0
Platoon blocked, %			
Mov Cap-1 Maneuver	-	907	-
Mov Cap-2 Maneuver	-	-	-
Stage 1	-	-	-
Stage 2	-	-	-

Approach	EB	NB	SB
HCM Control Delay, s	9	0	0
HCM LOS	A		

Minor Lane/Major Mvmt	NBT EBLn1	SBT	SBR
Capacity (veh/h)	- 907	-	-
HCM Lane V/C Ratio	- 0.016	-	-
HCM Control Delay (s)	- 9	-	-
HCM Lane LOS	- A	-	-
HCM 95th %tile Q(veh)	- 0	-	-

Lanes, Volumes, Timings
5: 103rd Avenue & Tower Road

10/03/2023

												
Lane Group	EBL	EBT	EBR	WBL	WBT	WBR	NBL	NBT	NBR	SBL	SBT	SBR
Lane Configurations												
Traffic Volume (vph)	15	1	51	191	1	388	181	2450	122	217	1706	12
Future Volume (vph)	15	1	51	191	1	388	181	2450	122	217	1706	12
Ideal Flow (vphpl)	1900	1900	1900	1900	1900	1900	1900	1900	1900	1900	1900	1900
Storage Length (ft)	45		50	100		100	440		185	130		0
Storage Lanes	0		1	0		1	1		1	1		1
Taper Length (ft)	25			25			25			25		
Lane Util. Factor	1.00	1.00	1.00	1.00	1.00	1.00	1.00	0.91	1.00	1.00	0.91	1.00
Frt			0.850			0.850			0.850			0.850
Flt Protected		0.955			0.953		0.950			0.950		
Satd. Flow (prot)	0	1779	1583	0	1775	1583	1770	5085	1583	1770	5085	1583
Flt Permitted		0.955			0.953		0.070			0.067		
Satd. Flow (perm)	0	1779	1583	0	1775	1583	130	5085	1583	125	5085	1583
Right Turn on Red			Yes			Yes			Yes			Yes
Satd. Flow (RTOR)			68			79			114			114
Link Speed (mph)		30			30			30			30	
Link Distance (ft)		875			922			428			530	
Travel Time (s)		19.9			21.0			9.7			12.0	
Peak Hour Factor	0.78	0.78	0.78	0.87	0.78	0.88	0.84	0.95	0.83	0.87	0.93	0.78
Adj. Flow (vph)	19	1	65	220	1	441	215	2579	147	249	1834	15
Shared Lane Traffic (%)												
Lane Group Flow (vph)	0	20	65	0	221	441	215	2579	147	249	1834	15
Enter Blocked Intersection	No	No	No	No	No	No	No	No	No	No	No	No
Lane Alignment	Left	Left	Right	Left	Left	Right	Left	Left	Right	Left	Left	Right
Median Width(ft)		0			0			12			12	
Link Offset(ft)		0			0			0			0	
Crosswalk Width(ft)		16			16			16			16	
Two way Left Turn Lane												
Headway Factor	1.00	1.00	1.00	1.00	1.00	1.00	1.00	1.00	1.00	1.00	1.00	1.00
Turning Speed (mph)	15		60	60		9	60		60	15		9
Number of Detectors	1	1	1	1	1	0	1	2	1	1	2	1
Detector Template	Left	Thru	Right	Left	Thru	Right	Left	Thru	Right	Left	Thru	Right
Leading Detector (ft)	20	20	20	20	20	0	20	100	20	20	100	20
Trailing Detector (ft)	0	0	0	0	0	0	0	0	0	0	0	0
Detector 1 Position(ft)	0	0	0	0	0	0	0	0	0	0	0	0
Detector 1 Size(ft)	20	20	20	20	20	20	20	6	20	20	6	20
Detector 1 Type	Cl+Ex	Cl+Ex	Cl+Ex	Cl+Ex	Cl+Ex	Cl+Ex	Cl+Ex	Cl+Ex	Cl+Ex	Cl+Ex	Cl+Ex	Cl+Ex
Detector 1 Channel												
Detector 1 Extend (s)	0.0	0.0	0.0	0.0	0.0	0.0	0.0	0.0	0.0	0.0	0.0	0.0
Detector 1 Queue (s)	0.0	0.0	0.0	0.0	0.0	0.0	0.0	0.0	0.0	0.0	0.0	0.0
Detector 1 Delay (s)	0.0	0.0	0.0	0.0	0.0	0.0	0.0	0.0	0.0	0.0	0.0	0.0
Detector 2 Position(ft)								94			94	
Detector 2 Size(ft)								6			6	
Detector 2 Type								Cl+Ex			Cl+Ex	
Detector 2 Channel												
Detector 2 Extend (s)								0.0			0.0	
Turn Type	Split	NA	pm+ov	Split	NA	pm+ov	pm+pt	NA	Perm	pm+pt	NA	Perm
Protected Phases	4	4	5	8	8	1	5	2		1	6	
Permitted Phases			4			8	2		2	6		6

Lanes, Volumes, Timings
5: 103rd Avenue & Tower Road

10/03/2023



Lane Group	EBL	EBT	EBR	WBL	WBT	WBR	NBL	NBT	NBR	SBL	SBT	SBR
Detector Phase	4	4	5	8	8	1	5	2	2	1	6	6
Switch Phase												
Minimum Initial (s)	5.0	5.0	5.0	5.0	5.0	5.0	5.0	5.0	5.0	5.0	5.0	5.0
Minimum Split (s)	11.0	11.0	11.0	11.0	11.0	10.5	11.0	23.5	23.5	10.5	23.5	23.5
Total Split (s)	12.0	12.0	16.0	28.0	28.0	18.0	16.0	62.0	62.0	18.0	64.0	64.0
Total Split (%)	10.0%	10.0%	13.3%	23.3%	23.3%	15.0%	13.3%	51.7%	51.7%	15.0%	53.3%	53.3%
Maximum Green (s)	7.0	7.0	11.0	22.5	22.5	13.0	11.0	57.0	57.0	13.0	59.0	59.0
Yellow Time (s)	3.0	3.0	3.0	3.5	3.5	3.0	3.0	3.0	3.0	3.0	3.0	3.0
All-Red Time (s)	2.0	2.0	2.0	2.0	2.0	2.0	2.0	2.0	2.0	2.0	2.0	2.0
Lost Time Adjust (s)		0.0	0.0		0.0	0.0	0.0	0.0	0.0	0.0	0.0	0.0
Total Lost Time (s)		5.0	5.0		5.5	5.0	5.0	5.0	5.0	5.0	5.0	5.0
Lead/Lag			Lead			Lead	Lead	Lag	Lag	Lead	Lag	Lag
Lead-Lag Optimize?			Yes			Yes	Yes	Yes	Yes	Yes	Yes	Yes
Vehicle Extension (s)	3.0	3.0	3.0	3.0	3.0	3.0	3.0	3.0	3.0	3.0	3.0	3.0
Recall Mode	None	None	None	None	None	None	None	Min	Min	None	Min	Min
Act Effct Green (s)		6.4	13.6		17.8	36.4	68.5	57.5	57.5	72.6	59.5	59.5
Actuated g/C Ratio		0.06	0.13		0.16	0.34	0.63	0.53	0.53	0.67	0.55	0.55
v/c Ratio		0.19	0.25		0.76	0.76	0.86	0.96	0.16	0.88	0.66	0.02
Control Delay		56.5	8.2		61.1	35.8	59.2	35.6	5.5	60.4	20.1	0.0
Queue Delay		0.0	0.0		0.0	0.0	0.0	0.0	0.0	0.0	0.0	0.0
Total Delay		56.5	8.2		61.1	35.8	59.2	35.6	5.5	60.4	20.1	0.0
LOS		E	A		E	D	E	D	A	E	C	A
Approach Delay		19.6			44.3			35.8			24.7	
Approach LOS		B			D			D			C	

Intersection Summary

Area Type:	Other
Cycle Length:	120
Actuated Cycle Length:	108.3
Natural Cycle:	100
Control Type:	Actuated-Uncoordinated
Maximum v/c Ratio:	0.96
Intersection Signal Delay:	32.5
Intersection LOS:	C
Intersection Capacity Utilization:	89.6%
ICU Level of Service:	E
Analysis Period (min):	15

Splits and Phases: 5: 103rd Avenue & Tower Road

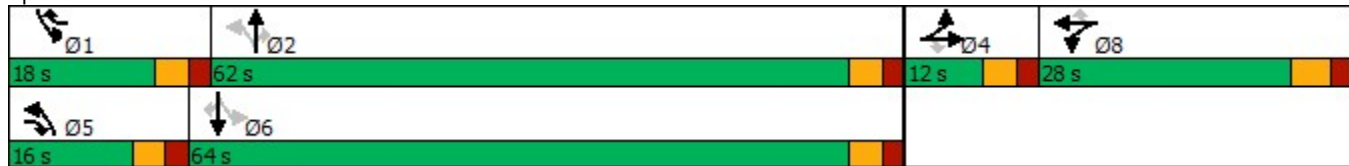

Queues

5: 103rd Avenue & Tower Road

10/03/2023

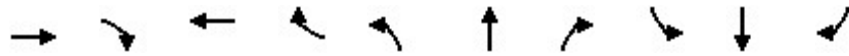























Lane Group	EBT	EBR	WBT	WBR	NBL	NBT	NBR	SBL	SBT	SBR
Lane Group Flow (vph)	20	65	221	441	215	2579	147	249	1834	15
v/c Ratio	0.19	0.25	0.76	0.76	0.86	0.96	0.16	0.88	0.66	0.02
Control Delay	56.5	8.2	61.1	35.8	59.2	35.6	5.5	60.4	20.1	0.0
Queue Delay	0.0	0.0	0.0	0.0	0.0	0.0	0.0	0.0	0.0	0.0
Total Delay	56.5	8.2	61.1	35.8	59.2	35.6	5.5	60.4	20.1	0.0
Queue Length 50th (ft)	13	0	139	208	89	539	10	110	281	0
Queue Length 95th (ft)	36	18	209	365	#239	#900	41	#295	460	0
Internal Link Dist (ft)	795		842			348			450	
Turn Bay Length (ft)		50		100	440		185	130		
Base Capacity (vph)	115	258	371	584	250	2697	893	282	2792	920
Starvation Cap Reductn	0	0	0	0	0	0	0	0	0	0
Spillback Cap Reductn	0	0	0	0	0	0	0	0	0	0
Storage Cap Reductn	0	0	0	0	0	0	0	0	0	0
Reduced v/c Ratio	0.17	0.25	0.60	0.76	0.86	0.96	0.16	0.88	0.66	0.02

Intersection Summary

95th percentile volume exceeds capacity, queue may be longer.
 Queue shown is maximum after two cycles.

HCM 6th Signalized Intersection Summary
 5: 103rd Avenue & Tower Road

10/03/2023

												
Movement	EBL	EBT	EBR	WBL	WBT	WBR	NBL	NBT	NBR	SBL	SBT	SBR
Lane Configurations												
Traffic Volume (veh/h)	15	1	51	191	1	388	181	2450	122	217	1706	12
Future Volume (veh/h)	15	1	51	191	1	388	181	2450	122	217	1706	12
Initial Q (Qb), veh	0	0	0	0	0	0	0	0	0	0	0	0
Ped-Bike Adj(A_pbT)	1.00		1.00	1.00		1.00	1.00		1.00	1.00		1.00
Parking Bus, Adj	1.00	1.00	1.00	1.00	1.00	1.00	1.00	1.00	1.00	1.00	1.00	1.00
Work Zone On Approach		No			No			No			No	
Adj Sat Flow, veh/h/ln	1870	1870	1870	1870	1870	1870	1870	1870	1870	1870	1870	1870
Adj Flow Rate, veh/h	19	1	65	220	1	441	215	2579	147	249	1834	15
Peak Hour Factor	0.78	0.78	0.78	0.87	0.78	0.88	0.84	0.95	0.83	0.87	0.93	0.78
Percent Heavy Veh, %	2	2	2	2	2	2	2	2	2	2	2	2
Cap, veh/h	87	5	202	250	1	407	275	2598	807	272	2802	870
Arrive On Green	0.05	0.05	0.05	0.14	0.14	0.14	0.08	0.51	0.51	0.12	0.55	0.55
Sat Flow, veh/h	1696	89	1585	1774	8	1585	1781	5106	1585	1781	5106	1585
Grp Volume(v), veh/h	20	0	65	221	0	441	215	2579	147	249	1834	15
Grp Sat Flow(s),veh/h/ln	1786	0	1585	1782	0	1585	1781	1702	1585	1781	1702	1585
Q Serve(g_s), s	1.2	0.0	4.2	13.6	0.0	15.8	6.4	56.1	5.6	11.3	28.3	0.5
Cycle Q Clear(g_c), s	1.2	0.0	4.2	13.6	0.0	15.8	6.4	56.1	5.6	11.3	28.3	0.5
Prop In Lane	0.95		1.00	1.00		1.00	1.00		1.00	1.00		1.00
Lane Grp Cap(c), veh/h	92	0	202	251	0	407	275	2598	807	272	2802	870
V/C Ratio(X)	0.22	0.00	0.32	0.88	0.00	1.08	0.78	0.99	0.18	0.92	0.65	0.02
Avail Cap(c_a), veh/h	112	0	220	358	0	502	314	2598	807	272	2802	870
HCM Platoon Ratio	1.00	1.00	1.00	1.00	1.00	1.00	1.00	1.00	1.00	1.00	1.00	1.00
Upstream Filter(I)	1.00	0.00	1.00	1.00	0.00	1.00	1.00	1.00	1.00	1.00	1.00	1.00
Uniform Delay (d), s/veh	51.0	0.0	44.5	47.2	0.0	41.6	19.7	27.3	14.9	36.7	17.8	11.5
Incr Delay (d2), s/veh	1.2	0.0	0.9	16.3	0.0	64.6	10.7	15.9	0.1	33.4	0.6	0.0
Initial Q Delay(d3),s/veh	0.0	0.0	0.0	0.0	0.0	0.0	0.0	0.0	0.0	0.0	0.0	0.0
%ile BackOfQ(50%),veh/ln	0.6	0.0	1.7	7.2	0.0	18.4	3.6	25.4	2.0	9.3	10.8	0.2
Unsig. Movement Delay, s/veh												
LnGrp Delay(d),s/veh	52.2	0.0	45.4	63.6	0.0	106.2	30.4	43.2	15.0	70.0	18.4	11.5
LnGrp LOS	D	A	D	E	A	F	C	D	B	E	B	B
Approach Vol, veh/h		85			662			2941			2098	
Approach Delay, s/veh		47.0			92.0			40.9			24.4	
Approach LOS		D			F			D			C	
Timer - Assigned Phs	1	2		4	5	6		8				
Phs Duration (G+Y+Rc), s	18.0	62.0		10.8	13.5	66.5		21.3				
Change Period (Y+Rc), s	5.0	5.0		5.0	5.0	5.0		5.5				
Max Green Setting (Gmax), s	13.0	57.0		7.0	11.0	59.0		22.5				
Max Q Clear Time (g_c+I1), s	13.3	58.1		6.2	8.4	30.3		15.6				
Green Ext Time (p_c), s	0.0	0.0		0.0	0.2	17.5		0.1				
Intersection Summary												
HCM 6th Ctrl Delay			40.8									
HCM 6th LOS			D									

Appendix E
104th Retail and Restaurant Site Plan



① FINISHED FLOOR
1/16" = 1'-0"

104TH RETAIL AND RESTAURANT SHELL
104TH

ISSUE RECORD

NO.	PURPOSE	DATE

ISSUE DATE: 2023.08.10

DRAWN BY: JG

CHECKED BY: BU

SHEET TITLE
SITE PLAN

SHEET NO.
A100

Appendix F
Excerpts of the *Reunion Center* Master TIS, *103rd and Tower Road* – *Reunion Commercial Center TIS*, and *Reunion Center – Duet & Commercial Phase* Traffic Conformance Letter

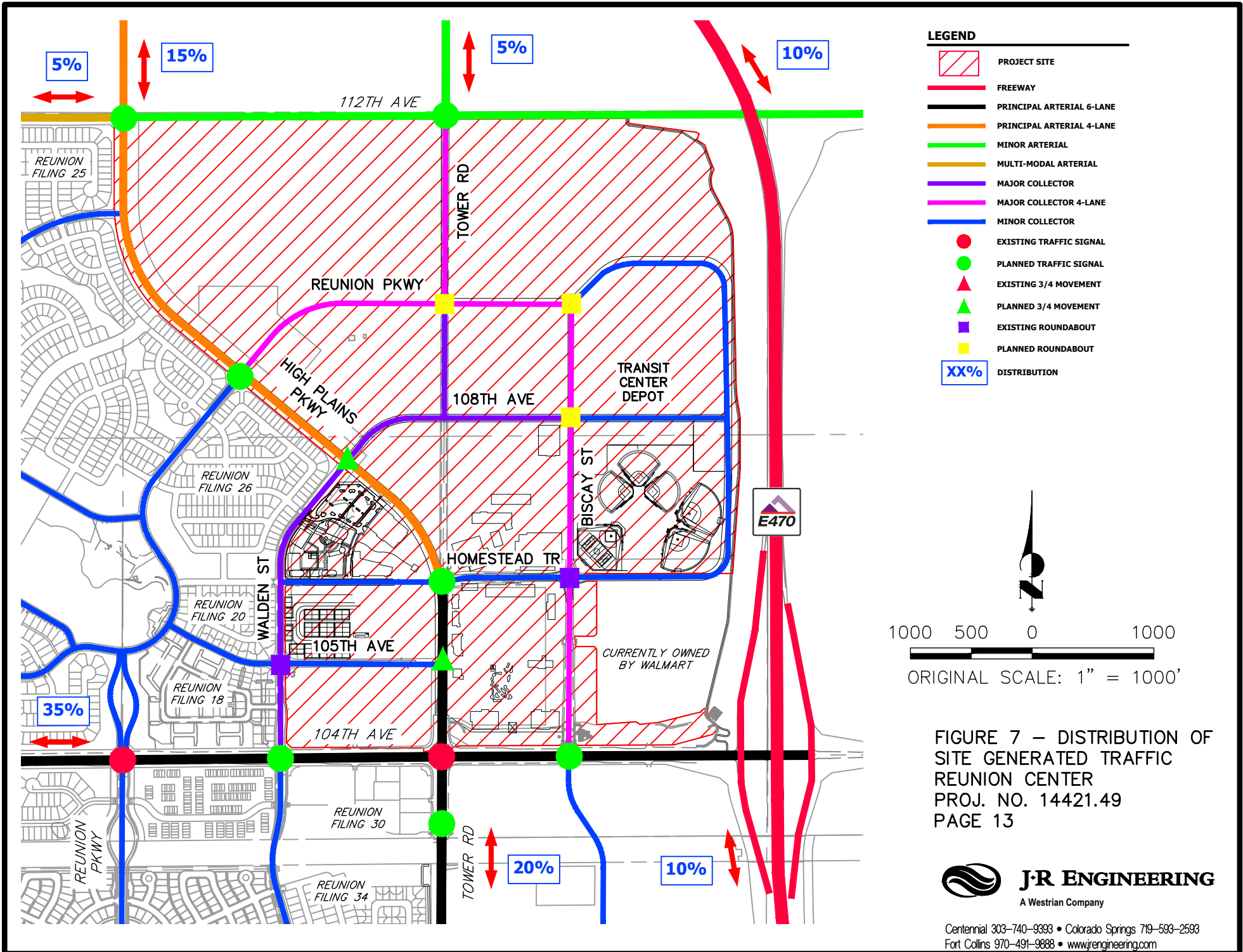

FIGURE 7 – DISTRIBUTION OF SITE GENERATED TRAFFIC
 REUNION CENTER
 PROJ. NO. 14421.49
 PAGE 13

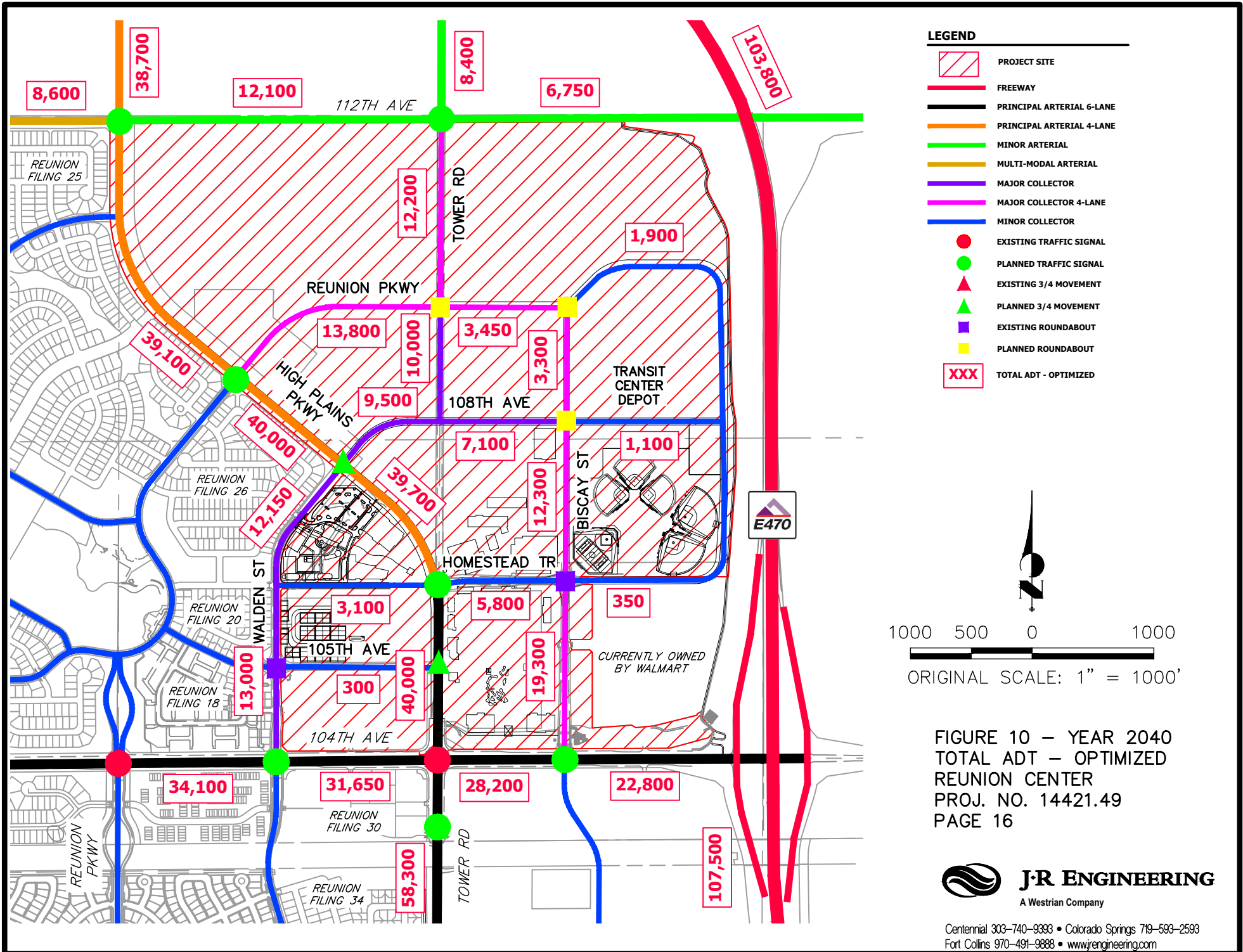
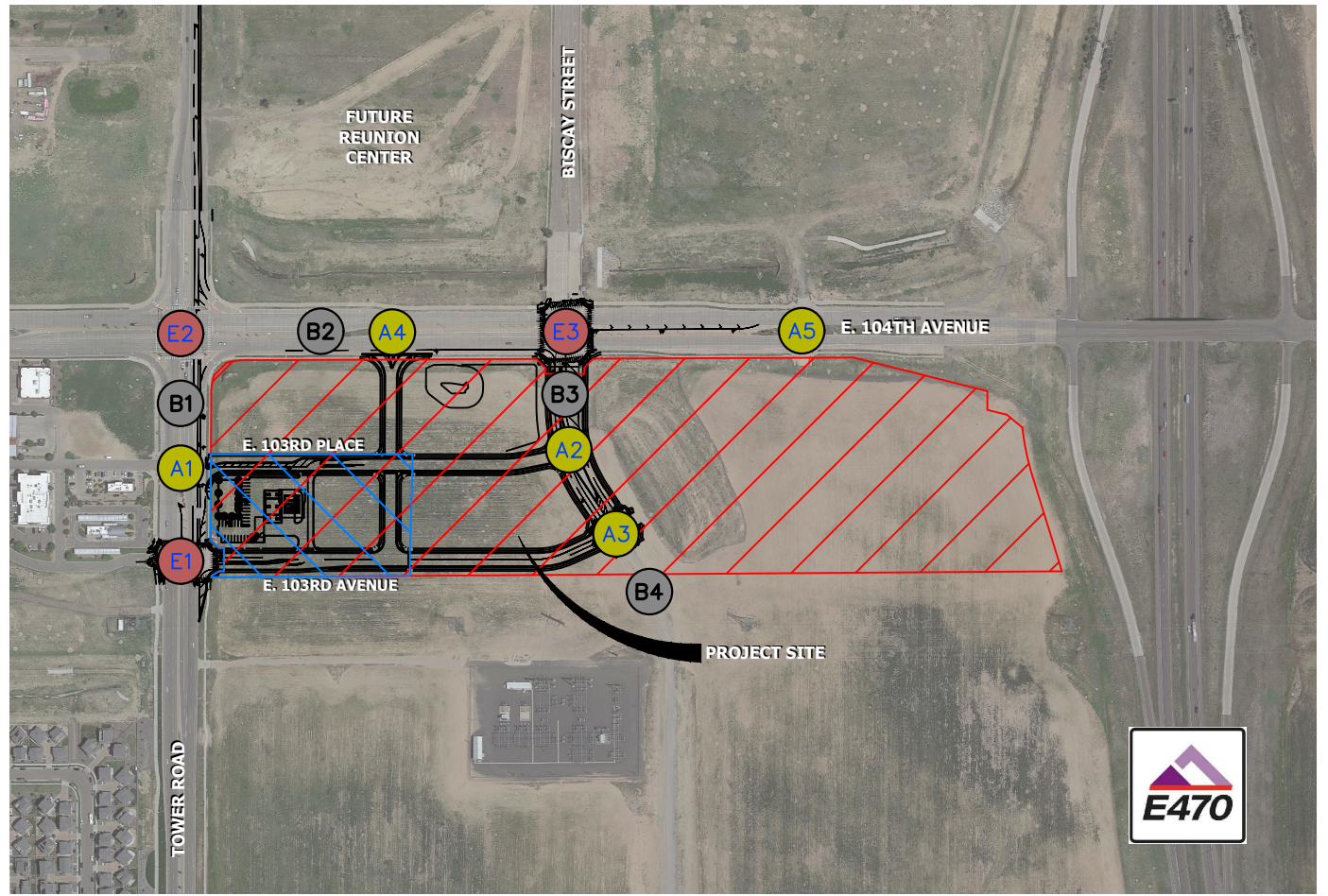
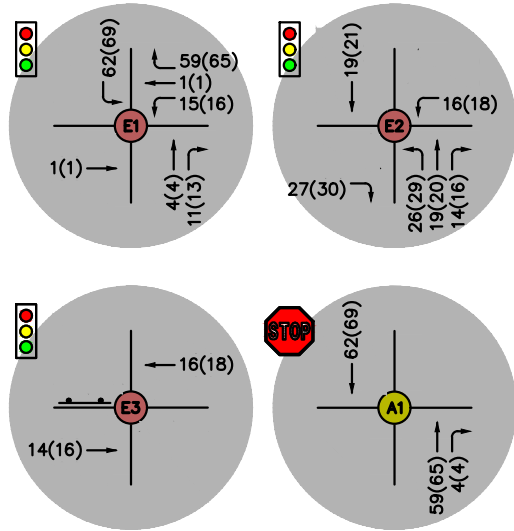

FIGURE 10 – YEAR 2040
TOTAL ADT – OPTIMIZED
REUNION CENTER
PROJ. NO. 14421.49
PAGE 16

TRAFFIC IMPACT STUDY
COMMERCE CITY, CO



NOTE

BISCAV STREET AND ACCESSES 2-5 ARE NOT PROPOSED TO BE CONSTRUCTED IN THE YEAR 2025

LEGEND

- PROPOSED INTERSECTION
- EXISTING INTERSECTION
- AVERAGE DAILY TRAFFIC (ADT)
- XX (XX) AM (PM) PEAK HOUR TRIP DISTRIBUTION
- SIGNAL CONTROL
- STOP SIGN CONTROL
- PROJECT SITE
- PHASE 1 PROJECT SITE

2025 SITE GEN ADT

- B1 493
- B2 493
- B3 0
- B4 0

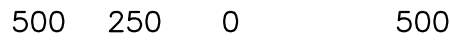

ORIGINAL SCALE: 1" = 500'

FIGURE 9—YEAR 2025 SITE GENERATED TRAFFIC
REUNION COMMERCIAL CENTER
JOB NO. 14421.51
PAGE 18



Centennial 303-740-9393 • Colorado Springs 719-593-2593
Fort Collins 970-491-9888 • www.jrengineering.com

TRAFFIC IMPACT STUDY
COMMERCE CITY, CO

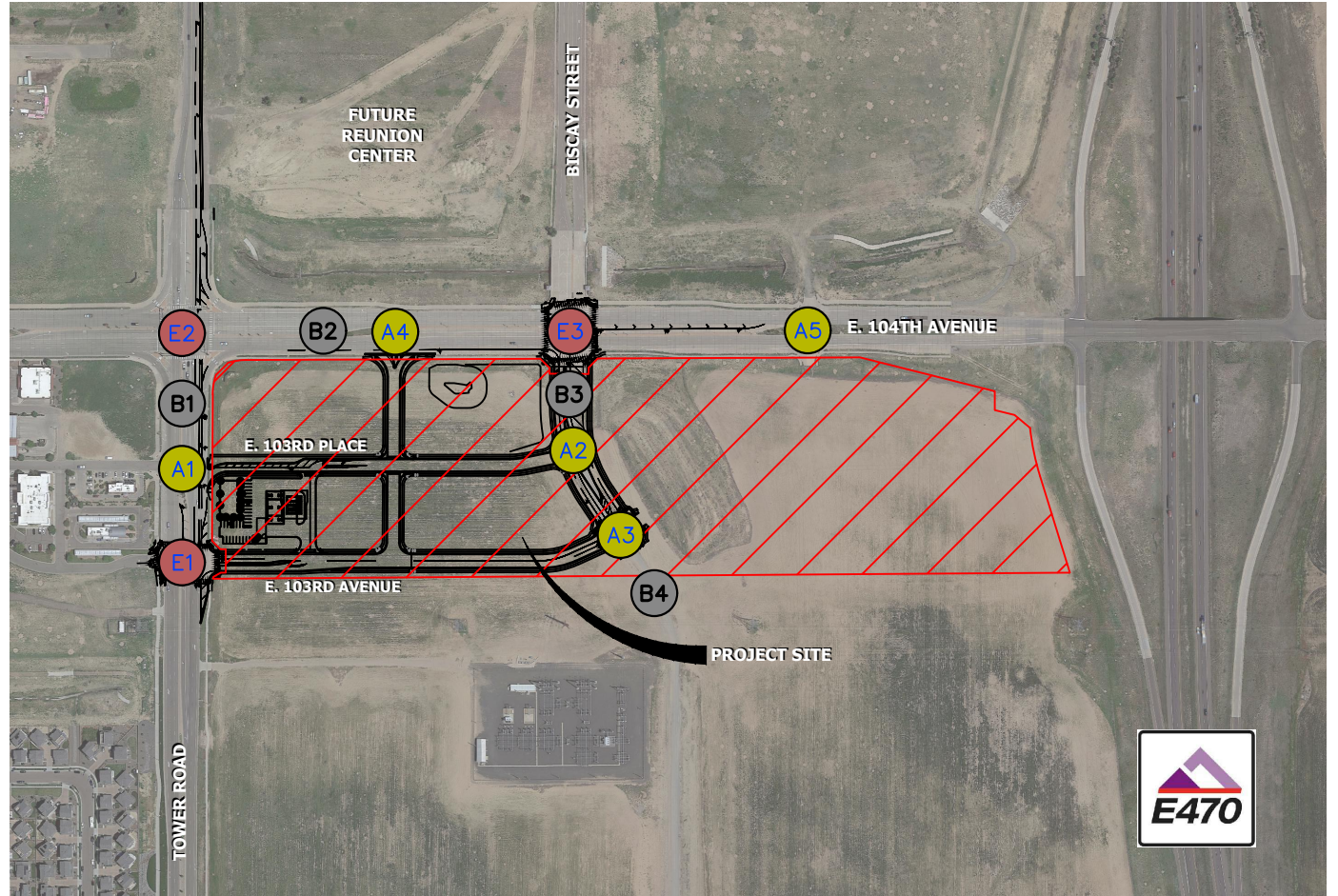
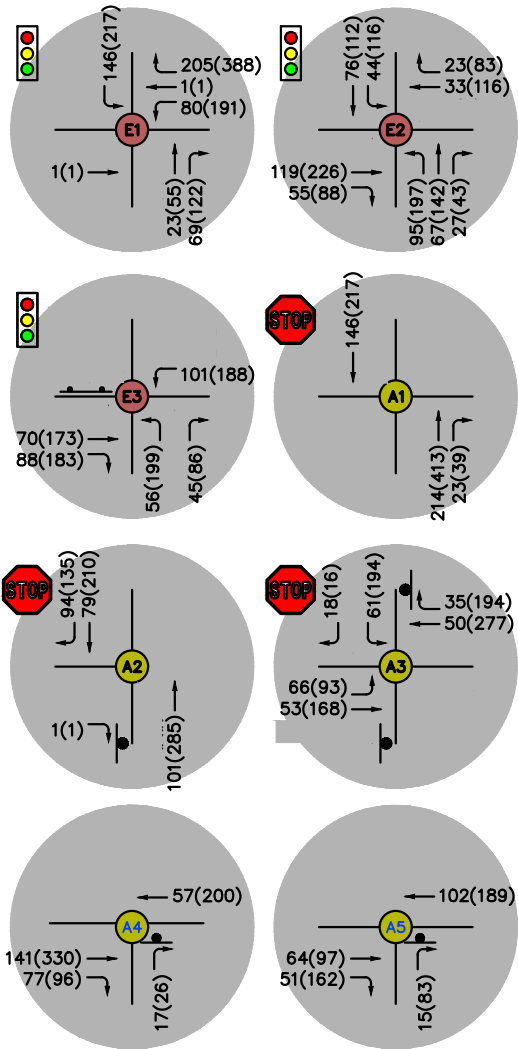

2027 SITE GEN ADT

B1	4,165
B2	4,165
B3	2,085
B4	0

LEGEND

- PROPOSED INTERSECTION
- EXISTING INTERSECTION
- AVERAGE DAILY TRAFFIC (ADT)
- AM (PM) PEAK HOUR TRIP DISTRIBUTION
- SIGNAL CONTROL
- STOP CONTROL
- STOP SIGN CONTROL
- PROJECT SITE



500 250 0 500

ORIGINAL SCALE: 1" = 500'

FIGURE 12—YEAR 2027 SITE
GENERATED TRAFFIC
REUNION COMMERCIAL CENTER
JOB NO. 14421.51
PAGE 21



Centennial 303-740-9393 • Colorado Springs 719-593-2593
Fort Collins 970-491-9888 • www.jrengineering.com

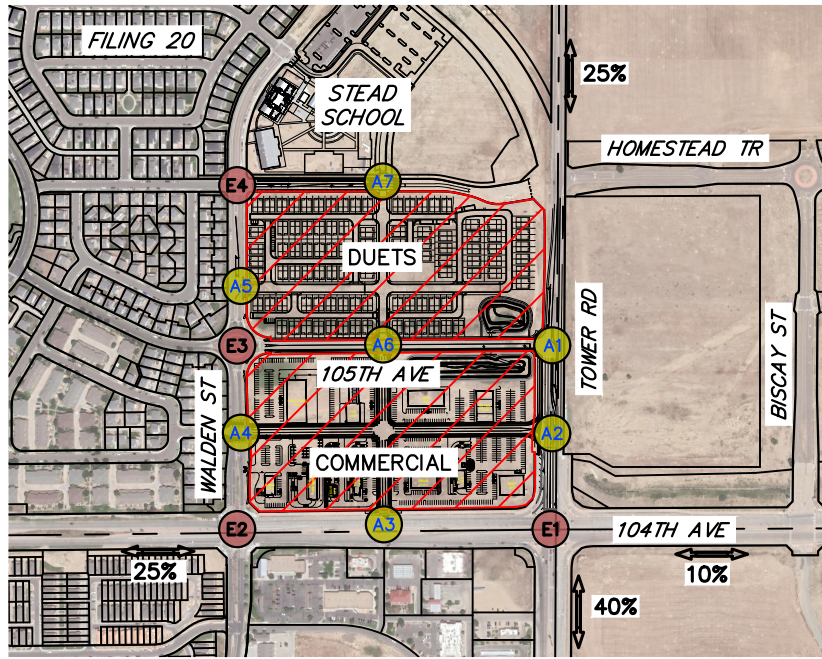
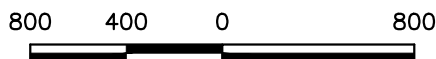
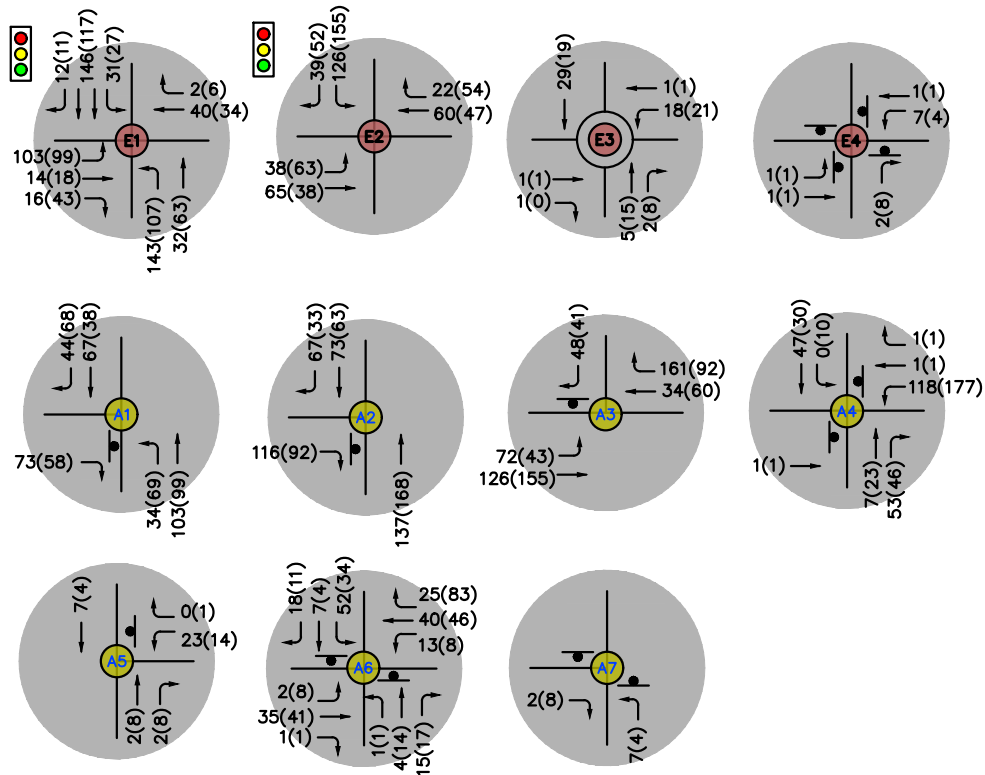

Figure 2 - Assignment of Site Generated Traffic



ORIGINAL SCALE: 1" = 800'

LEGEND

- PROPOSED INTERSECTION
- EXISTING INTERSECTION
- AM (PM) PEAK HOUR TRIP DISTRIBUTION
- STOP SIGN CONTROL
- ROUNDABOUT CONTROL
- TRAFFIC SIGNAL
- PROJECT SITE