

**NOTES:**

Not to Scale

Created Date: 03/01/24



**SITE MAP**  
 Concrete Flatwork 2024  
 COMMERCE CITY  
 Department of Public Works  
 8602 Rosemary St.  
 Commerce City, CO 80022  
[www.c3gov.com](http://www.c3gov.com)  
 Tel: (303) 289-8150  
 Fax: (303) 289-8165

REVISIONS			
NO.	BY	DATE	DESCRIPTION
Contact:			COMMERCE CITY
Phone:			303-289-8150
Email:			@c3gov.com





## 56th Ave Industrial Park Concrete

3. 56th Ave/Fairfax St NE corner  
4' Sidewalk

5. 5025 E 56th Ave  
Curb & Gutter

6. 5599 Holly St  
Driveway

7. 5690 56th Ave,  
SE corner of drive, Ramp

8. 56th Ave/Fairfax St NE corner  
Ramp

9. 5605 56th Ave  
Traffic Control island

49. 5025 E 56th Ave  
4' Sidewalk

**NOTES:**

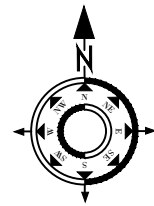

Not to Scale

Created Date: 03/01/24



### 56th Ave Industrial Park

Concrete Flatwork 2024  
 COMMERCE CITY  
 Department of Public Works  
 8602 Rosemary St.  
 Commerce City, CO 80022  
[www.c3gov.com](http://www.c3gov.com)  
 Tel: (303) 289-8150  
 Fax: (303) 289-8165

### REVISIONS

NO.	BY	DATE	DESCRIPTION

Contact: COMMERCE CITY  
 Phone: 303-289-8150  
 Email: @c3gov.com



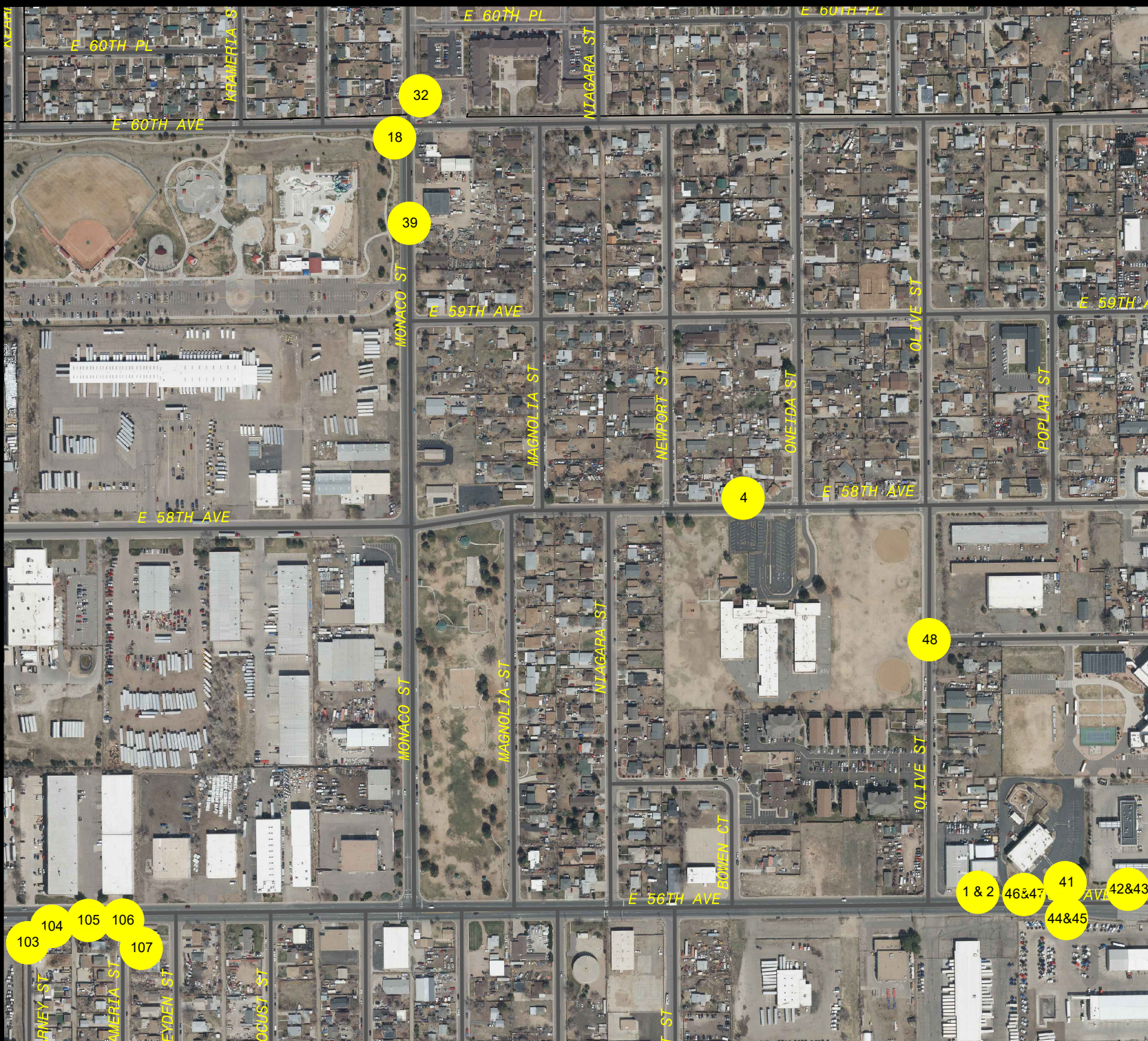

## 56th Ave Industrial Park Concrete

1. 7051 E 56th Ave 4' Sidewalk	2. 7051 E 56th Ave 4' Sidewalk
4. 6821 E 58th Ave 4.5' Combo(Curb,Gutter,Sidewalk)	18. E 60th Ave & Monaco St SW corner RAMP
32. E 60th Ave & Monaco St EAST side Curb & Gutter	39. 5890 Monaco St 4' Sidewalk
41. 7111 56th Ave 5' Sidewalk	42. 5601 Quebec St Curb & Gutter #1
43. 5601 Quebec St Curb & Gutter #2	44. 7111 E 56th Ave (east driveway) Ramp #1
45. 7111 E 56th Ave (east driveway) Ramp #2	46. 7111 E 56th Ave (west driveway) Ramp #1
47. 7111 E 56th Ave (west driveway) Ramp #1	48. E 57th Pl & Olive St NE corner RAMP
103. 5596 Holly St (new) Curb & Gutter	104. 5596 Holly St (new) Ramp
105. 5596 Holly St/5599 Krameria St (new) 5' Sidewalk	106. 5599 Krameria St (new) Curb & Gutter
107. 5599 Krameria St (new) Ramp	

**NOTES:**

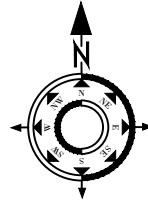

Not to Scale

Created Date: 03/01/24



**56th Ave Industrial Park**  
 Concrete Flatwork 2024  
 COMMERCE CITY  
 Department of Public Works  
 8602 Rosemary St.  
 Commerce City, CO 80022  
[www.c3gov.com](http://www.c3gov.com)  
 Tel: (303) 289-8150  
 Fax: (303) 289-8165

REVISIONS			
NO.	BY	DATE	DESCRIPTION

Contact:	COMMERCE CITY
Phone:	303-289-8150
Email:	@c3gov.com

3 of 15



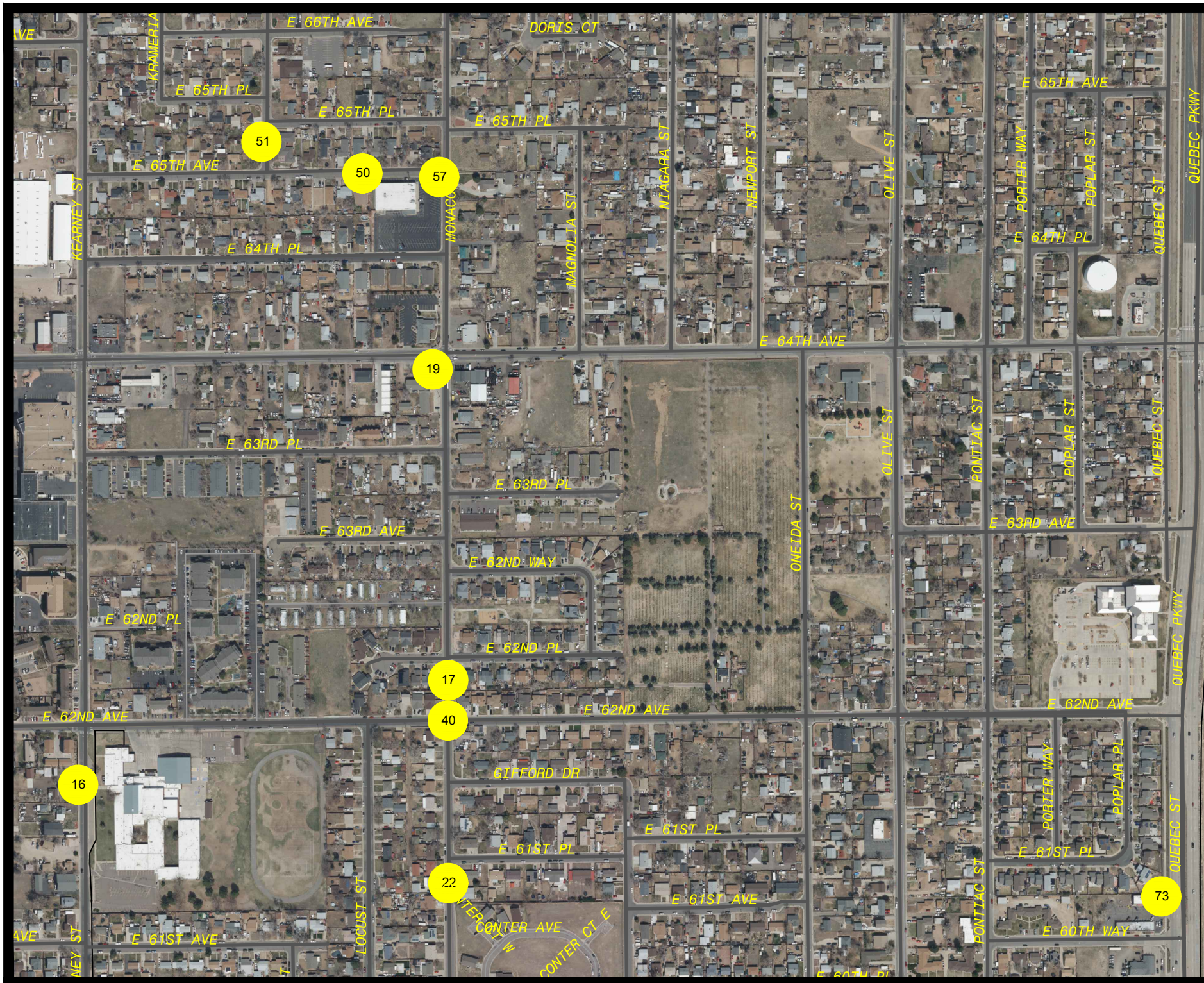

Monaco Concrete	
16. 6161 Kearney St 6.5' Combo (Curb, Gutter, Sidewalk)	17. Monaco St S of 62nd Pl west side Inlet curb and gutter
19. 64th Ave & Monaco St SW corner Ramp	22. 6100 Monaco Street 5.5' Combo (Curb, Gutter, Sidewalk)
40. 62nd Ave & Monaco St SE corner 4' Sidewalk	50. 6300 65th Ave 4.5' Combo (Curb, Gutter, Sidewalk)
51. 6280 E 65th Pl west side on Leyden St 5.5' Combo (Curb, Gutter, Sidewalk)	57. 65th Ave & Monaco St SW corner Ramp
73. 6075 Quebec St 8' Sidewalk	

**NOTES:**

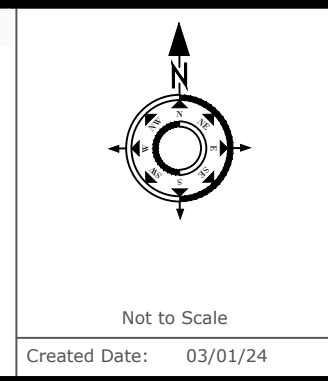

**Monaco**  
 Concrete Flatwork 2024  
 COMMERCE CITY  
 Department of Public Works  
 8602 Rosemary St.  
 Commerce City, CO 80022  
 www.c3gov.com  
 Tel: (303) 289-8150  
 Fax: (303) 289-8165

REVISIONS			
NO.	BY	DATE	DESCRIPTION

Contact:	COMMERCE CITY
Phone:	303-289-8150
Email:	@c3gov.com



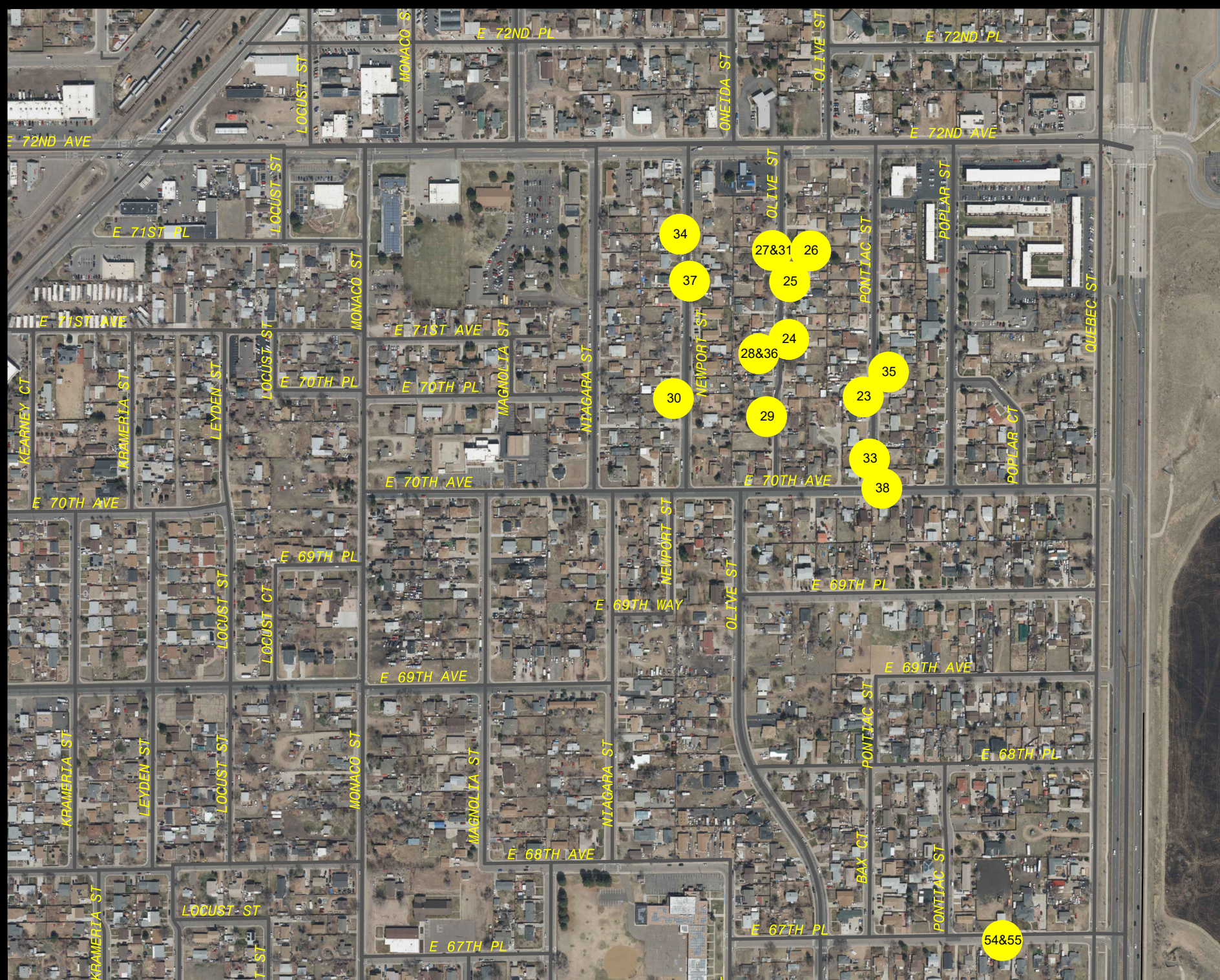

Derby Concrete	
23. 7061 Pontiac St 6.5' Combo (Curb, Gutter, Sidewalk)	24. 7110 Olive St 6.5' Combo (Curb, Gutter, Sidewalk)
25. 7150 Olive St 6.5' Combo (Curb, Gutter, Sidewalk)	26. 7156 Olive St 6.5' Combo (Curb, Gutter, Sidewalk)
27. 7161 Olive St 6.5' Combo (Curb, Gutter, Sidewalk)	28. 7095 Olive St 6.5' Combo (Curb, Gutter, Sidewalk)
29. 7071 Olive St 6.5' Combo (Curb, Gutter, Sidewalk)	30. 7051 Newport St 6.5' Combo (Curb, Gutter, Sidewalk)
31. 7161 Olive St 6.5' Combo with Manhole	33. 7010 Pontiac St Driveway
34. 7155 Newport St Driveway	35. 7070 Pontiac St Inlet curb and gutter
36. 7095 Olive St Inlet curb and gutter	37. 7140 Newport St Inlet curb and gutter
38. 70th Ave & Pontiac St NE corner Ramp	54. 7200 67th PI 5.5' Combo (Curb, Gutter, Sidewalk)
55. 7200 67th PI 5.5' Combo (Curb, Gutter, Sidewalk)	

**NOTES:**

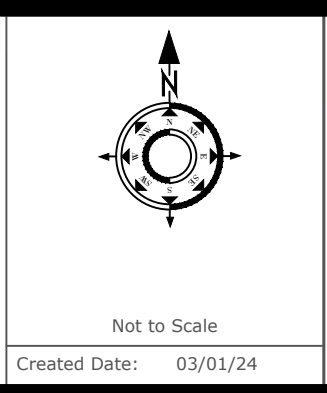

**Derby**  
 Concrete Flatwork 2024  
 COMMERCE CITY  
 Department of Public Works  
 8602 Rosemary St.  
 Commerce City, CO 80022  
 www.c3gov.com  
 Tel: (303) 289-8150  
 Fax: (303) 289-8165

REVISIONS			
NO.	BY	DATE	DESCRIPTION
Contact:	COMMERCE CITY		
Phone:	303-289-8150		
Email:	@c3gov.com		



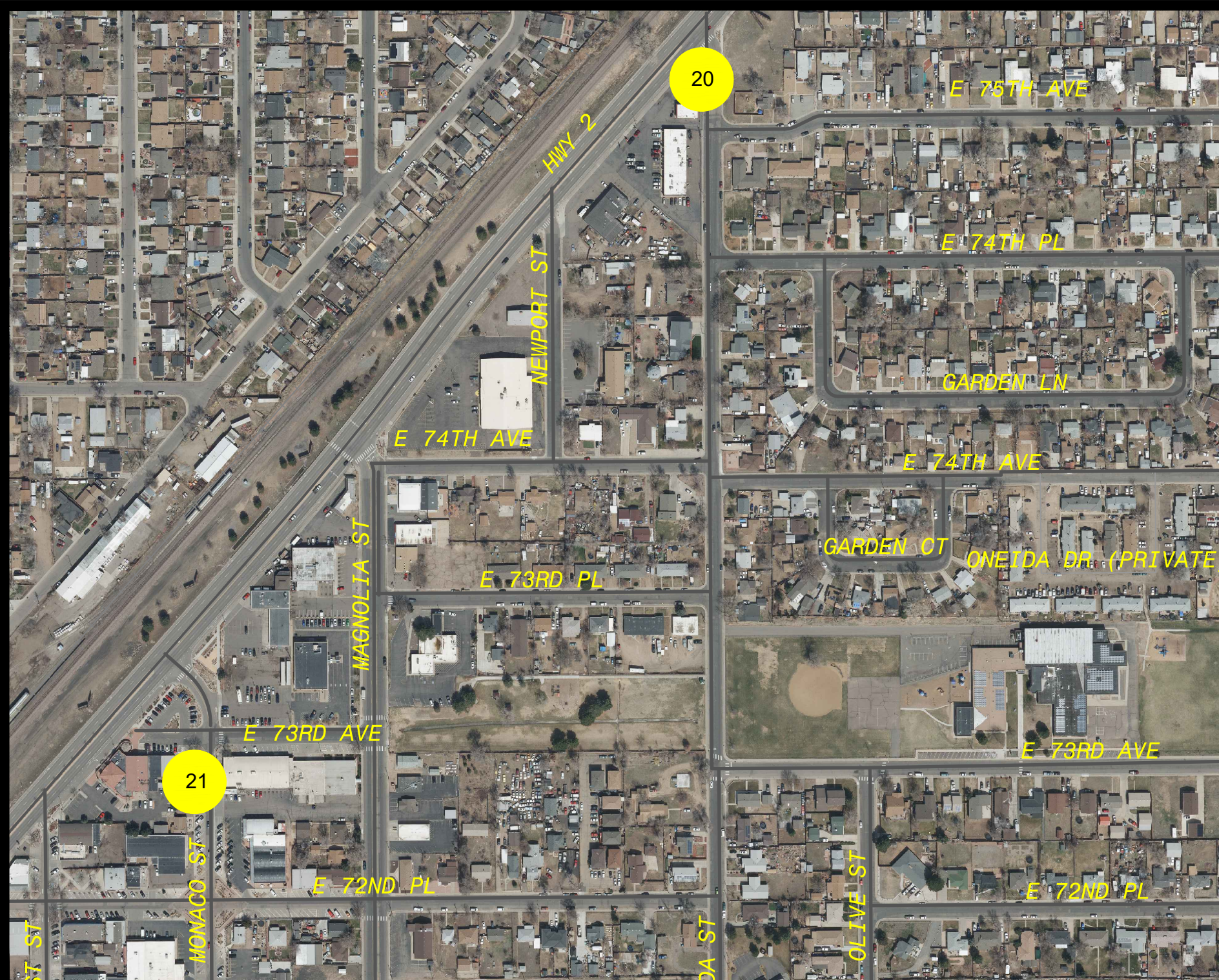

# Derby Concrete

20. Oneida St S of Highway 2  
SB Curb & Gutter

21. 7295 Monaco St  
Parking Panel

**NOTES:**

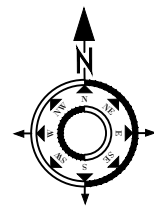

Not to Scale

Created Date: 03/01/24



**Derby**  
Concrete Flatwork 2024  
COMMERCE CITY  
Department of Public Works  
8602 Rosemary St.  
Commerce City, CO 80022  
www.c3gov.com  
Tel: (303) 289-8150  
Fax: (303) 289-8165

**REVISIONS**

NO.	BY	DATE	DESCRIPTION

Contact: COMMERCE CITY  
Phone: 303-289-8150  
Email: @c3gov.com





# Tichy Concrete

**52.** 5561 67th Pl  
5.5' Combo (Curb, Gutter, Sidewalk)

**53.** 5441 67th Pl  
5.5' Combo (Curb, Gutter, Sidewalk)

**56.** 5561 67th Pl  
5.5' Combo (Curb, Gutter, Sidewalk)

**NOTES:**

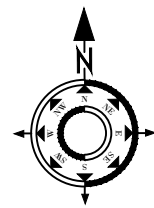

Not to Scale

Created Date: 03/01/24



**Tichy**  
Concrete Flatwork 2024  
COMMERCE CITY  
Department of Public Works  
8602 Rosemary St.  
Commerce City, CO 80022  
www.c3gov.com  
Tel: (303) 289-8150  
Fax: (303) 289-8165

## REVISIONS

NO.	BY	DATE	DESCRIPTION

Contact: COMMERCE CITY  
Phone: 303-289-8150  
Email: @c3gov.com



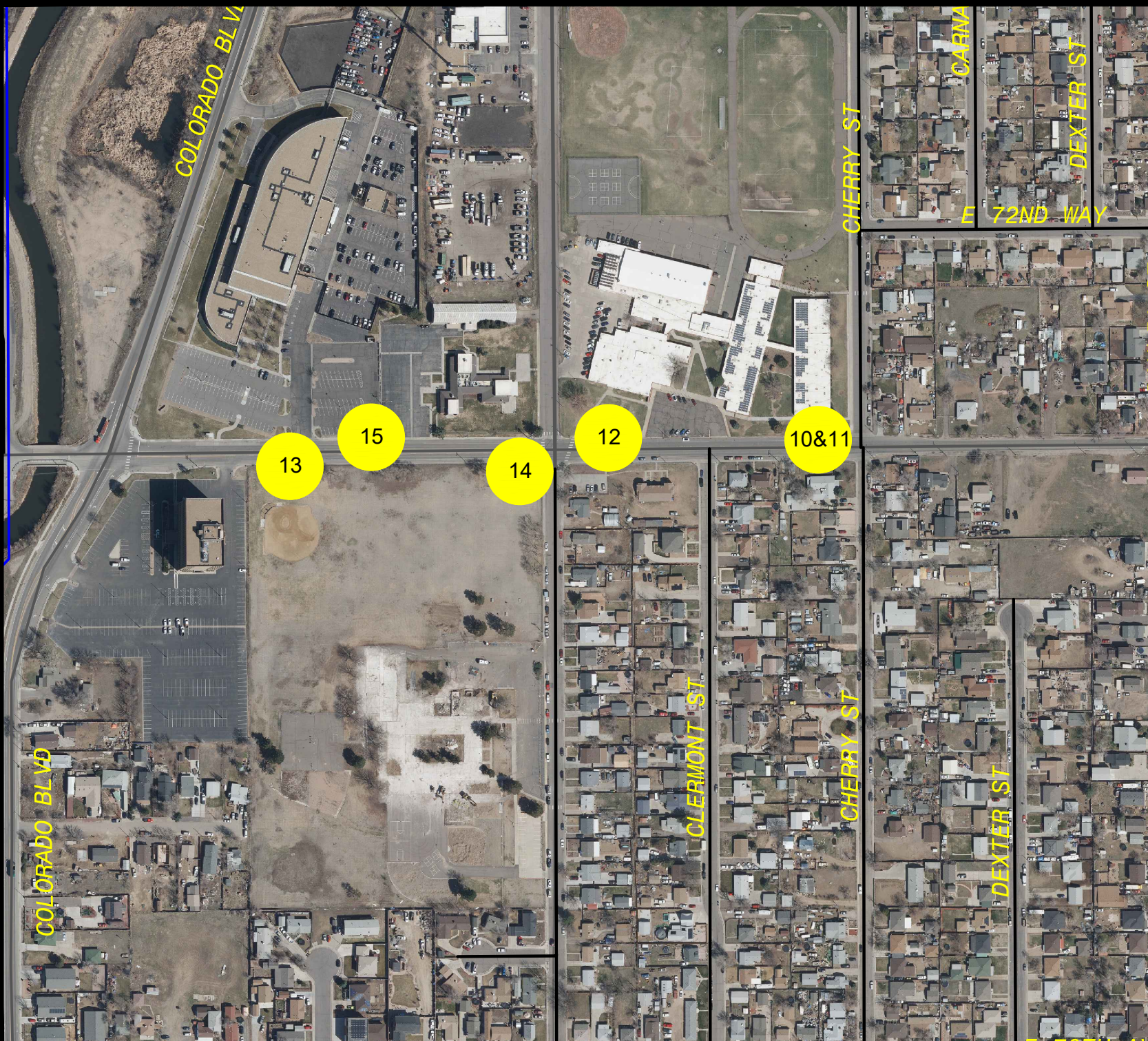

## E 72nd Ave Concrete

<b>10.</b> 4513 E 72nd Ave 6" Curb & Gutter	<b>11.</b> 4513 E 72nd Ave 6" Curb & Gutter
<b>12.</b> 4400 E 72nd Ave 6" Curb & Gutter	<b>13.</b> 4242 E 72nd Ave Curb & Gutter
<b>14.</b> 4398 E 72nd Ave Curb & Gutter	<b>15.</b> 4731 E 72nd Ave Curb & Gutter

**NOTES:**

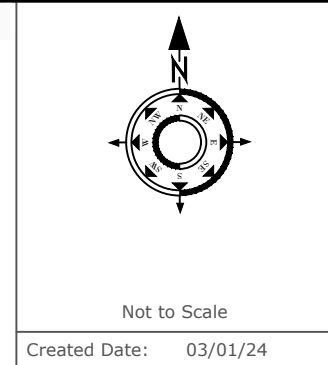

**E 72nd Ave**  
 Concrete Flatwork 2024  
 COMMERCE CITY  
 Department of Public Works  
 8602 Rosemary St.  
 Commerce City, CO 80022  
[www.c3gov.com](http://www.c3gov.com)  
 Tel: (303) 289-8150  
 Fax: (303) 289-8165

REVISIONS			
NO.	BY	DATE	DESCRIPTION

Contact:	COMMERCE CITY	<b>8 of 15</b>
Phone:	303-289-8150	
Email:	@c3gov.com	



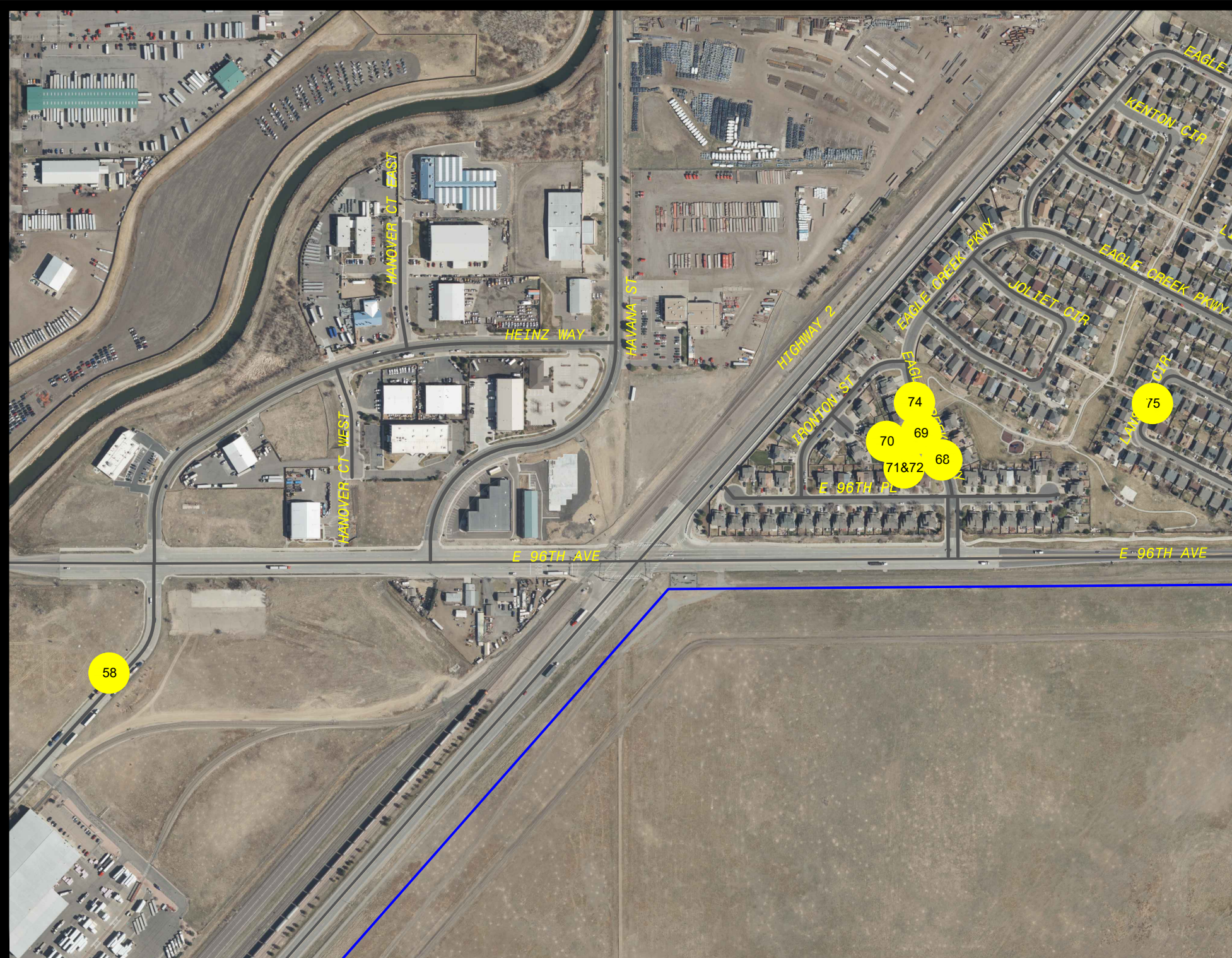

## Eagle Creek Concrete

<b>58.</b> Heinz Way S of 96th Ave west side Inlet curb and gutter	<b>68.</b> 9648 Eagle Creek Pkwy 6.5' Combo (Curb, Gutter, Sidewalk)
<b>69.</b> 9652 Eagle Creek Pkwy 6.5' Combo (Curb, Gutter, Sidewalk)	<b>70.</b> 9667 Eagle Creek Pkwy 6.5' Combo (Curb, Gutter, Sidewalk)
<b>71.</b> 9659 Eagle Creek Pkwy 6.5' Combo (Curb, Gutter, Sidewalk)	<b>72.</b> 9655 Eagle Creek Pkwy 6.5' Combo (Curb, Gutter, Sidewalk)
<b>74.</b> 9664 Eagle Creek Pkwy Inlet curb and gutter	<b>75.</b> Between 9653 and 9655 Lansing Cir Ramp

### NOTES:

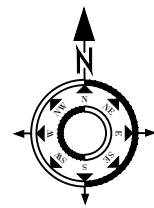

Not to Scale

Created Date: 03/01/24



## Eagle Creek Subdivision

Concrete Flatwork 2024

COMMERCE CITY

Department of Public Works

8602 Rosemary St.  
Commerce City, CO 80022  
www.c3gov.com  
Tel: (303) 289-8150  
Fax: (303) 289-8165

### REVISIONS

NO.	BY	DATE	DESCRIPTION

Contact:	COMMERCE CITY
Phone:	303-289-8150
Email:	@c3gov.com









## E 104th Ave Concrete

<b>59.</b> Hwy 2 SB, turn lane to WB 104th Ave (2 panels) Remove & Replace Concrete Panels	<b>99.</b> 104th Ave EB from Hwy 2 right lane (3 panels) Remove & Replace Concrete Panels
<b>100.</b> 104th Ave EB from Hwy 2 right lane (1 panel) Remove & Replace Concrete Panels	<b>101.</b> 104th Ave EB from Hwy 2 center lane (2 panels) Remove & Replace Concrete Panels

**NOTES:**

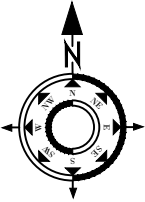

Not to Scale

Created Date: 03/01/24



**E 104th Ave**  
 Concrete Flatwork 2024  
 COMMERCE CITY  
 Department of Public Works  
 8602 Rosemary St.  
 Commerce City, CO 80022  
[www.c3gov.com](http://www.c3gov.com)  
 Tel: (303) 289-8150  
 Fax: (303) 289-8165

REVISIONS			
NO.	BY	DATE	DESCRIPTION

Contact:	COMMERCE CITY	<b>11 of 15</b>
Phone:	303-289-8150	
Email:	@c3gov.com	

















# The Village Concrete

92. 12170 Village Circle East Curb & Gutter

**NOTES:**

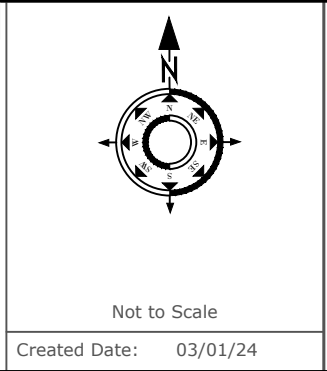

**The Village**  
 Concrete Flatwork 2024  
 COMMERCE CITY  
 Department of Public Works  
 8602 Rosemary St.  
 Commerce City, CO 80022  
 www.c3gov.com  
 Tel: (303) 289-8150  
 Fax: (303) 289-8165

REVISIONS			
NO.	BY	DATE	DESCRIPTION

Contact:	COMMERCE CITY	<b>15 of 15</b>
Phone:	303-289-8150	
Email:	@c3gov.com	